





Codice assieme	Descrizione assieme	Immagine assieme
ASM2926A/0.D01	Impianto elettrico	
ASM2921A/0.D01	Porta	
ASM2911A/0.D02	Camera di cottura	
ASM2916A/0.D01	Copertura esterna	

**ASM2926A/0.D01 - Impianto elettrico**



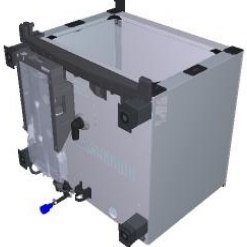
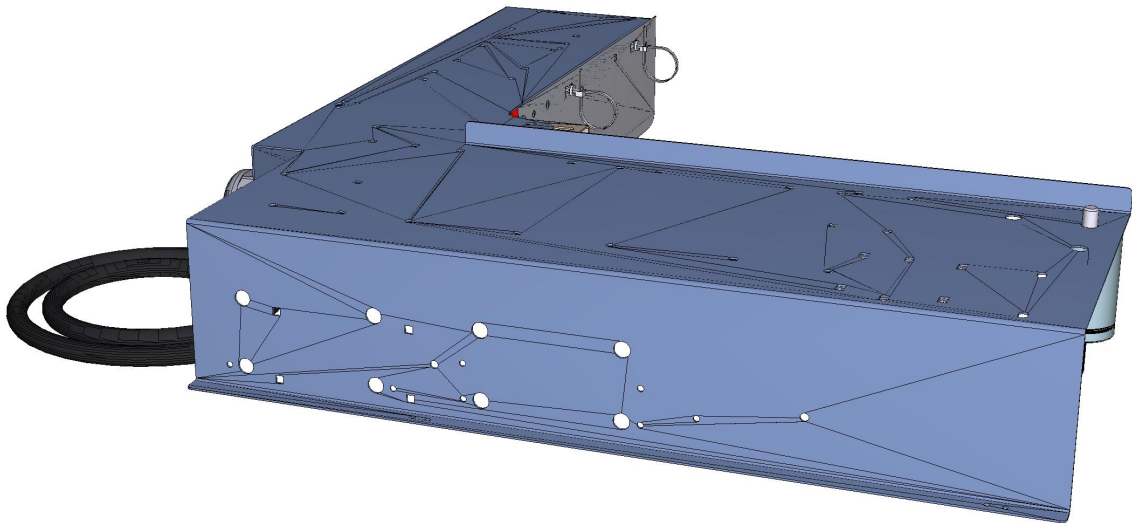

**FRONTE**



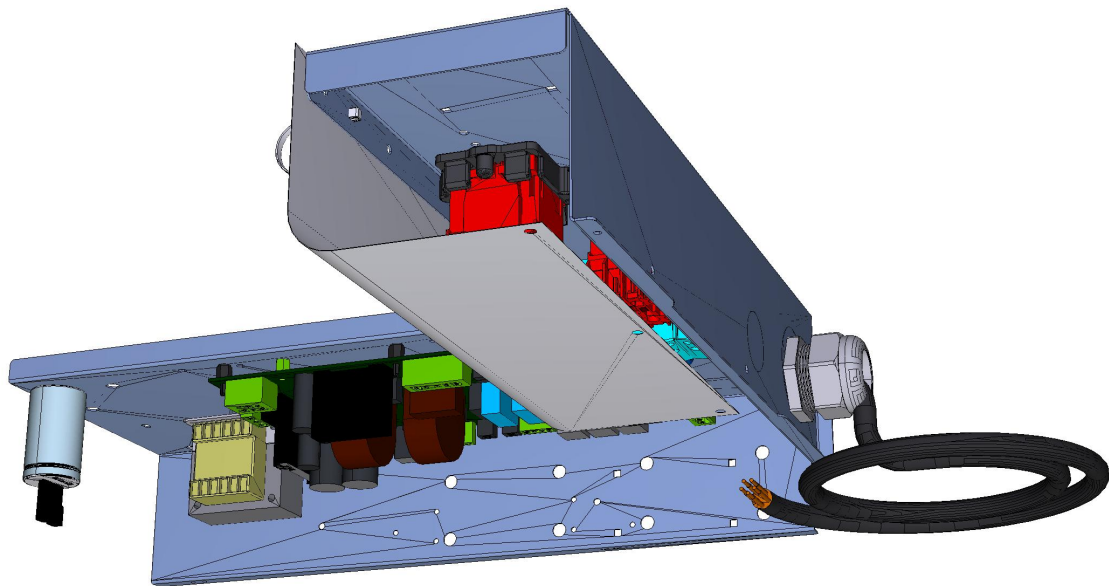

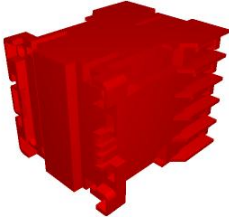

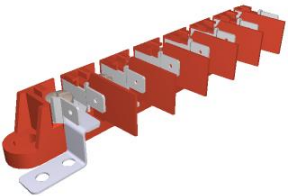

ASM2926A/0.D01 - Impianto elettrico

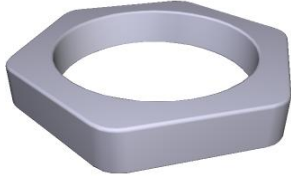
RETRO

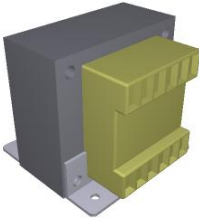

COMPONENTE			RICAMBIO																		
Codice	Descrizione	Immagine	Codice	Descrizione	Lista componenti																
CN1003A	CONDENSATORE CORAZZATO 6,3 UF		KCN1003A	KIT CONDENSATORE MOTORE 6,3 UF	<table border="1"> <thead> <tr> <th>Codice</th> <th>Descrizione</th> <th>Qtà</th> <th>UM</th> </tr> </thead> <tbody> <tr> <td>CN1003A0</td> <td>CONDENSATO RE CORAZZATO 6,3 UF</td> <td>1</td> <td>PZ</td> </tr> <tr> <td>VI1931A0</td> <td>DADO M8X1.65 H4 CH13 ZINCATO</td> <td>1</td> <td>PZ</td> </tr> <tr> <td>VI1932A0</td> <td>RONDELLA DENTELLATA D8 ZINCATA</td> <td>1</td> <td>PZ</td> </tr> </tbody> </table>	Codice	Descrizione	Qtà	UM	CN1003A0	CONDENSATO RE CORAZZATO 6,3 UF	1	PZ	VI1931A0	DADO M8X1.65 H4 CH13 ZINCATO	1	PZ	VI1932A0	RONDELLA DENTELLATA D8 ZINCATA	1	PZ
Codice	Descrizione	Qtà	UM																		
CN1003A0	CONDENSATO RE CORAZZATO 6,3 UF	1	PZ																		
VI1931A0	DADO M8X1.65 H4 CH13 ZINCATO	1	PZ																		
VI1932A0	RONDELLA DENTELLATA D8 ZINCATA	1	PZ																		
VE1115A	MINICONTATTORE QUADRIPOLORE 20 A 230V		KVE1115A	KIT MINICONTATTORE QUADRIPOLORE 20A 230V	<table border="1"> <thead> <tr> <th>Codice</th> <th>Descrizione</th> <th>Qtà</th> <th>UM</th> </tr> </thead> <tbody> <tr> <td>VE1115A0</td> <td>MINICONTATT ORE QUADRIPOLO RE 20 A 230V</td> <td>1</td> <td>PZ</td> </tr> <tr> <td>VM1075A1</td> <td>CLIP DI FISSAGGIO PER TELERUTTORI</td> <td>4</td> <td>PZ</td> </tr> </tbody> </table>	Codice	Descrizione	Qtà	UM	VE1115A0	MINICONTATT ORE QUADRIPOLO RE 20 A 230V	1	PZ	VM1075A1	CLIP DI FISSAGGIO PER TELERUTTORI	4	PZ				
Codice	Descrizione	Qtà	UM																		
VE1115A0	MINICONTATT ORE QUADRIPOLO RE 20 A 230V	1	PZ																		
VM1075A1	CLIP DI FISSAGGIO PER TELERUTTORI	4	PZ																		
VM1056A	STAFFA TELERUTTORE PICCOLO VE1115A		VM1056A0	STAFFA TELERUTTORE PICCOLO VE1115A																	
MR1004A	MORSETTIERA 7POLI 41A 450V		KMR1004A	KIT MORSETTIERA 7 POLI	<table border="1"> <thead> <tr> <th>Codice</th> <th>Descrizione</th> <th>Qtà</th> <th>UM</th> </tr> </thead> <tbody> <tr> <td>MR1004A1</td> <td>MORSETTIER A 7POLI 41A 450V</td> <td>1</td> <td>PZ</td> </tr> </tbody> </table>	Codice	Descrizione	Qtà	UM	MR1004A1	MORSETTIER A 7POLI 41A 450V	1	PZ								
Codice	Descrizione	Qtà	UM																		
MR1004A1	MORSETTIER A 7POLI 41A 450V	1	PZ																		
VE1645A	PRESSACAPO PG 29																				

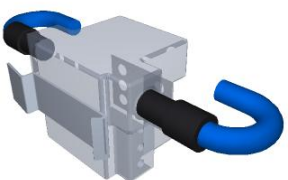
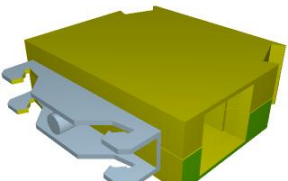
COMPONENTE			RICAMBIO																						
Codice	Descrizione	Immagine	Codice	Descrizione	Lista componenti																				
VE1644A	DADO PRESSACAPO PG 29		VE1644A0	DADO PRESSACAPO PG 29																					
CE1355A	CAVO 5X2,5MMQ H07RN-F L=1,5MT		KCE1355A	KIT CAVO 5X2.5 MMQ L1.5MT CE1355A1	<table border="1"> <thead> <tr> <th>Codice</th> <th>Descrizione</th> <th>Qtà</th> <th>UM</th> </tr> </thead> <tbody> <tr> <td>CE1355A1</td> <td>CAVO 5X2,5MMQ H07RN-F L=1,5MT</td> <td>1</td> <td>PZ</td> </tr> </tbody> </table>	Codice	Descrizione	Qtà	UM	CE1355A1	CAVO 5X2,5MMQ H07RN-F L=1,5MT	1	PZ												
Codice	Descrizione	Qtà	UM																						
CE1355A1	CAVO 5X2,5MMQ H07RN-F L=1,5MT	1	PZ																						
PE2037A	SCHEDA POTENZA MM ONE		KPE2037A	KIT SCHEDA POTENZA MIND.MAPS ONE	<table border="1"> <thead> <tr> <th>Codice</th> <th>Descrizione</th> <th>Qtà</th> <th>UM</th> </tr> </thead> <tbody> <tr> <td>PE2037A0</td> <td>SCHEDA POTENZA MM ONE</td> <td>1</td> <td>PZ</td> </tr> <tr> <td>VI1850A0</td> <td>VITE M4X6 TCB+ NICHELATA</td> <td>9</td> <td>PZ</td> </tr> <tr> <td>VM1745A0</td> <td>SUPPORTO PER SCHEDA</td> <td>9</td> <td>PZ</td> </tr> <tr> <td>VM2147A0</td> <td>SPUGNA ESD ROSA LISCIA 410X343X15 M</td> <td>1</td> <td>PZ</td> </tr> </tbody> </table>	Codice	Descrizione	Qtà	UM	PE2037A0	SCHEDA POTENZA MM ONE	1	PZ	VI1850A0	VITE M4X6 TCB+ NICHELATA	9	PZ	VM1745A0	SUPPORTO PER SCHEDA	9	PZ	VM2147A0	SPUGNA ESD ROSA LISCIA 410X343X15 M	1	PZ
Codice	Descrizione	Qtà	UM																						
PE2037A0	SCHEDA POTENZA MM ONE	1	PZ																						
VI1850A0	VITE M4X6 TCB+ NICHELATA	9	PZ																						
VM1745A0	SUPPORTO PER SCHEDA	9	PZ																						
VM2147A0	SPUGNA ESD ROSA LISCIA 410X343X15 M	1	PZ																						
VE1639A	TRASFORMATORE 230-12VAC 60VA		KVE1639A	KIT TRASFORMATORE 230-12VAC 60VA	<table border="1"> <thead> <tr> <th>Codice</th> <th>Descrizione</th> <th>Qtà</th> <th>UM</th> </tr> </thead> <tbody> <tr> <td>VE1639A0</td> <td>TRASFORMAT ORE 230-12VAC 60VA</td> <td>1</td> <td>PZ</td> </tr> <tr> <td>VI1950A0</td> <td>VITE AUTOFORANT E 4,2X13 TCB INOX</td> <td>4</td> <td>PZ</td> </tr> <tr> <td>VM2147A0</td> <td>SPUGNA ESD ROSA LISCIA 410X343X15 M</td> <td>1</td> <td>PZ</td> </tr> </tbody> </table>	Codice	Descrizione	Qtà	UM	VE1639A0	TRASFORMAT ORE 230-12VAC 60VA	1	PZ	VI1950A0	VITE AUTOFORANT E 4,2X13 TCB INOX	4	PZ	VM2147A0	SPUGNA ESD ROSA LISCIA 410X343X15 M	1	PZ				
Codice	Descrizione	Qtà	UM																						
VE1639A0	TRASFORMAT ORE 230-12VAC 60VA	1	PZ																						
VI1950A0	VITE AUTOFORANT E 4,2X13 TCB INOX	4	PZ																						
VM2147A0	SPUGNA ESD ROSA LISCIA 410X343X15 M	1	PZ																						

COMPONENTE			RICAMBIO										
Codice	Descrizione	Immagine	Codice	Descrizione	Lista componenti								
VM2387A	PROTEZIONE TELERUTTORI MM XEVC		VM2387A0	PROTEZIONE TELERUTTORI MM XEVC									
CE1420A	MORSETTIERA UNIPOLARE 8 VIE Z16-8D		KCE1420A	KIT MORSETTIERA UNIPOLARE 8 VIE Z16-8D	<table border="1"> <thead> <tr> <th>Codice</th> <th>Descrizione</th> <th>Qtà</th> <th>UM</th> </tr> </thead> <tbody> <tr> <td>CE1420A0</td> <td>MORSETTIERA UNIPOLARE 8 VIE Z16-8D</td> <td>1</td> <td>PZ</td> </tr> </tbody> </table>	Codice	Descrizione	Qtà	UM	CE1420A0	MORSETTIERA UNIPOLARE 8 VIE Z16-8D	1	PZ
Codice	Descrizione	Qtà	UM										
CE1420A0	MORSETTIERA UNIPOLARE 8 VIE Z16-8D	1	PZ										
MR1011A	MORSETTO DI TERRA UL 125A PER BARRA OMEG		KMR1011A	KIT MORSETTO DI TERRA MR1011A0	<table border="1"> <thead> <tr> <th>Codice</th> <th>Descrizione</th> <th>Qtà</th> <th>UM</th> </tr> </thead> <tbody> <tr> <td>MR1011A0</td> <td>MORSETTO DI TERRA UL 125A PER BARRA OMEG</td> <td>1</td> <td>PZ</td> </tr> </tbody> </table>	Codice	Descrizione	Qtà	UM	MR1011A0	MORSETTO DI TERRA UL 125A PER BARRA OMEG	1	PZ
Codice	Descrizione	Qtà	UM										
MR1011A0	MORSETTO DI TERRA UL 125A PER BARRA OMEG	1	PZ										
MR1009A	MORSETTIERA UNIPOLARE UL ERICO UD80A		MR1009A0	MORSETTIERA UNIPOLARE UL ERICO UD80A									
0H7092A	BARRA OMEGA L=17		0H7092A0	BARRA OMEGA L=17									

COMPONENTE			RICAMBIO		
<i>Codice</i>	<i>Descrizione</i>	<i>Immagine</i>	<i>Codice</i>	<i>Descrizione</i>	<i>Lista componenti</i>
0H7250A	PROFILO PORTA COMPONENTI MM ONE GN1-1		0H7250A0	PROFILO PORTA COMPONENTI MM ONE GN1-1	

**ASM2921A/0.D01 - Porta**

**FRONTE**

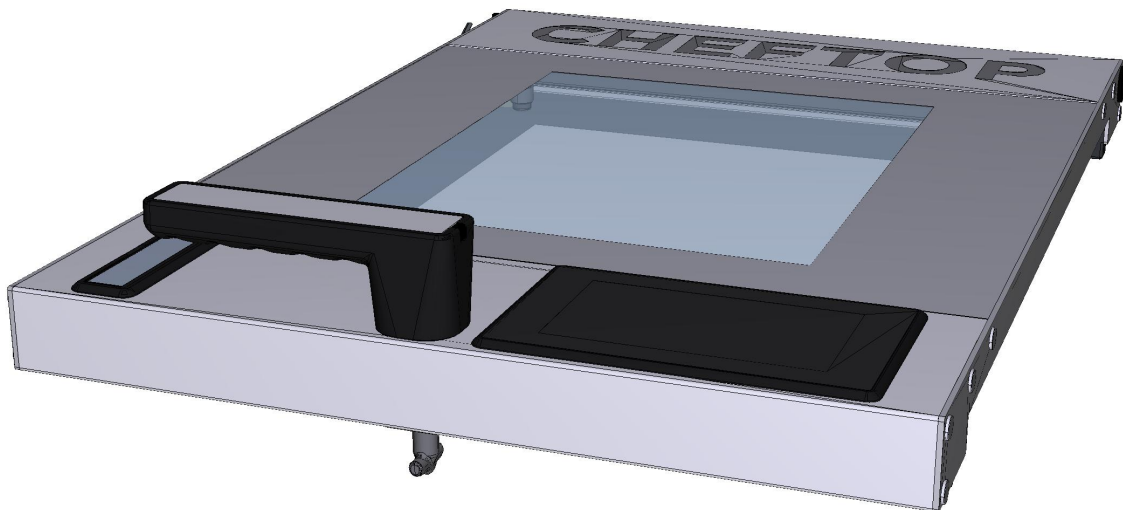



**ASM2921A/0.D01 - Porta**

**RETRO**

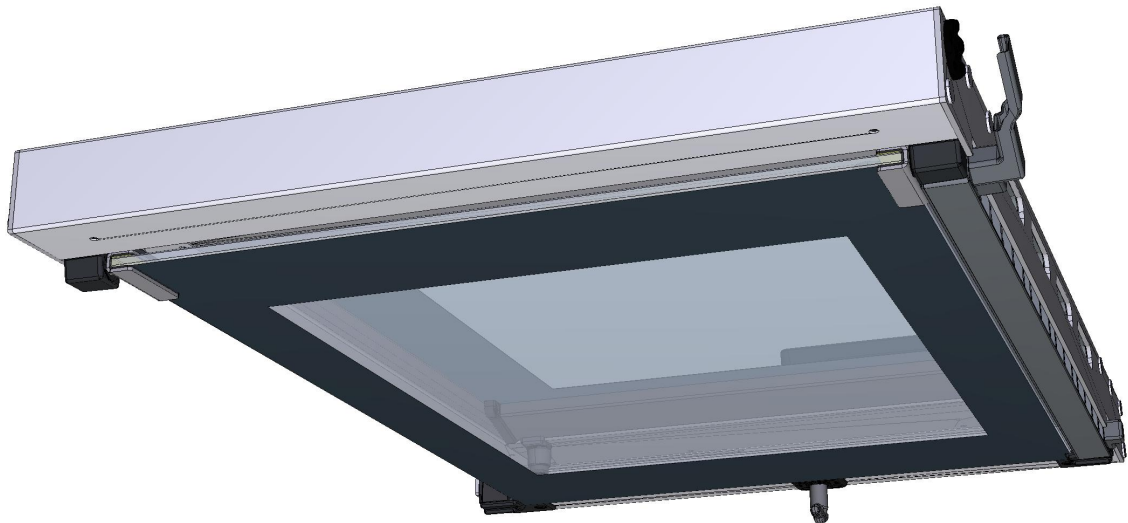

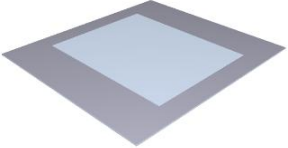
COMPONENTE			RICAMBIO																																		
Codice	Descrizione	Immagine	Codice	Descrizione	Lista componenti																																
VT1276A	VETRO ESTERNO SER. XEVC-0511-E		KVT1276A	KIT VETRO ESTERNO 0511	<table border="1"> <thead> <tr> <th>Codice</th> <th>Descrizione</th> <th>Qtà</th> <th>UM</th> </tr> </thead> <tbody> <tr> <td>0B1166A0</td> <td>PROFILO SUPPORTO VETRO ESTERNO</td> <td>2</td> <td>PZ</td> </tr> <tr> <td>IP1508A0</td> <td>POLISTIROLO PROFILO AD U 2000X60X60</td> <td>1</td> <td>PZ</td> </tr> <tr> <td>IP1508A1</td> <td>POLISTIROLO PROFILO AD U 2000X60X60</td> <td>1</td> <td>M</td> </tr> <tr> <td>SL1155A1</td> <td>SILICONE BICOMPONEN TE LOCTITE</td> <td>150</td> <td>ML</td> </tr> <tr> <td>SL1156A0</td> <td>PUNTALE PER PISTOLA SILICONE BICOMPONEN</td> <td>1</td> <td>PZ</td> </tr> <tr> <td>VM1059A1</td> <td>FILM TERMORETRA IBILE H800</td> <td>1.500</td> <td>M</td> </tr> <tr> <td>VT1276A0</td> <td>VETRO ESTERNO SER. XEVC-0511-E</td> <td>1</td> <td>PZ</td> </tr> </tbody> </table>	Codice	Descrizione	Qtà	UM	0B1166A0	PROFILO SUPPORTO VETRO ESTERNO	2	PZ	IP1508A0	POLISTIROLO PROFILO AD U 2000X60X60	1	PZ	IP1508A1	POLISTIROLO PROFILO AD U 2000X60X60	1	M	SL1155A1	SILICONE BICOMPONEN TE LOCTITE	150	ML	SL1156A0	PUNTALE PER PISTOLA SILICONE BICOMPONEN	1	PZ	VM1059A1	FILM TERMORETRA IBILE H800	1.500	M	VT1276A0	VETRO ESTERNO SER. XEVC-0511-E	1	PZ
			Codice	Descrizione	Qtà	UM																															
0B1166A0	PROFILO SUPPORTO VETRO ESTERNO	2	PZ																																		
IP1508A0	POLISTIROLO PROFILO AD U 2000X60X60	1	PZ																																		
IP1508A1	POLISTIROLO PROFILO AD U 2000X60X60	1	M																																		
SL1155A1	SILICONE BICOMPONEN TE LOCTITE	150	ML																																		
SL1156A0	PUNTALE PER PISTOLA SILICONE BICOMPONEN	1	PZ																																		
VM1059A1	FILM TERMORETRA IBILE H800	1.500	M																																		
VT1276A0	VETRO ESTERNO SER. XEVC-0511-E	1	PZ																																		
KDR1265A	PORTA ESTERNA 0511 LEFT	<table border="1"> <thead> <tr> <th>Codice</th> <th>Descrizione</th> <th>Qtà</th> <th>UM</th> </tr> </thead> <tbody> <tr> <td>0B1122A0</td> <td>TRAVERSO INFERIORE PORTA 750 M</td> <td>1</td> <td>PZ</td> </tr> <tr> <td>0B1166A0</td> <td>PROFILO SUPPORTO VETRO ESTERNO</td> <td>2</td> <td>PZ</td> </tr> <tr> <td>0B1195A0</td> <td>COLONNINA ESTERNA SX PORTA 0511 LEFT</td> <td>1</td> <td>PZ</td> </tr> <tr> <td>0B1196A0</td> <td>COLONNINA INTERNA DX PORTA 0511 LEFT</td> <td>1</td> <td>PZ</td> </tr> <tr> <td>0B1196A1</td> <td>COLONNINA INTERNA DX PORTA 0511 LEFT</td> <td>1</td> <td>PZ</td> </tr> <tr> <td>0B1197A0</td> <td>COLONNINA INTERNA SX PORTA 0511 LEFT</td> <td>1</td> <td>PZ</td> </tr> <tr> <td>0B1197A1</td> <td>COLONNINA INTERNA SX PORTA 0511 LEFT</td> <td>1</td> <td>PZ</td> </tr> </tbody> </table>	Codice	Descrizione	Qtà	UM	0B1122A0	TRAVERSO INFERIORE PORTA 750 M	1	PZ	0B1166A0	PROFILO SUPPORTO VETRO ESTERNO	2	PZ	0B1195A0	COLONNINA ESTERNA SX PORTA 0511 LEFT	1	PZ	0B1196A0	COLONNINA INTERNA DX PORTA 0511 LEFT	1	PZ	0B1196A1	COLONNINA INTERNA DX PORTA 0511 LEFT	1	PZ	0B1197A0	COLONNINA INTERNA SX PORTA 0511 LEFT	1	PZ	0B1197A1	COLONNINA INTERNA SX PORTA 0511 LEFT	1	PZ			
Codice	Descrizione	Qtà	UM																																		
0B1122A0	TRAVERSO INFERIORE PORTA 750 M	1	PZ																																		
0B1166A0	PROFILO SUPPORTO VETRO ESTERNO	2	PZ																																		
0B1195A0	COLONNINA ESTERNA SX PORTA 0511 LEFT	1	PZ																																		
0B1196A0	COLONNINA INTERNA DX PORTA 0511 LEFT	1	PZ																																		
0B1196A1	COLONNINA INTERNA DX PORTA 0511 LEFT	1	PZ																																		
0B1197A0	COLONNINA INTERNA SX PORTA 0511 LEFT	1	PZ																																		
0B1197A1	COLONNINA INTERNA SX PORTA 0511 LEFT	1	PZ																																		

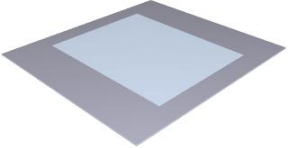
COMPONENTE			RICAMBIO																																																														
Codice	Descrizione	Immagine	Codice	Descrizione	Lista componenti																																																												
VT1276A	VETRO ESTERNO SER. XEVC-0511-E		KDR1265A	PORTA ESTERNA 0511 LEFT	<table border="1"> <thead> <tr> <th>Codice</th> <th>Descrizione</th> <th>Qtà</th> <th>UM</th> </tr> </thead> <tbody> <tr> <td>0B1206A0</td> <td>COLONNINA ESTERNA DX PORTA 0511 LEFT</td> <td>1</td> <td>PZ</td> </tr> <tr> <td>0B1216A0</td> <td>TRAVERSO SUPERIORE PORTA 750 MM 2V</td> <td>1</td> <td>PZ</td> </tr> <tr> <td>0B1217A0</td> <td>TRAVERSO SUPERIORE INT PORTA 750 MM 2V</td> <td>1</td> <td>PZ</td> </tr> <tr> <td>0B1217A1</td> <td>TRAVERSO SUPERIORE INT PORTA 750 S6 2V</td> <td>1</td> <td>PZ</td> </tr> <tr> <td>0H7321A0</td> <td>PIASTRINA COPERCHIETT O MANIGLIA M</td> <td>1</td> <td>PZ</td> </tr> <tr> <td>CE1052A0</td> <td>CAVO CONNESSION E CONTROLLO- USB MM 650M</td> <td>1</td> <td>PZ</td> </tr> <tr> <td>CE1052A1</td> <td>CAVO CONNESSION E CONTROLLO- USB MM 750M</td> <td>1</td> <td>PZ</td> </tr> <tr> <td>CE1053B0</td> <td>CAVO ALIMENT BARRA LED MM MICROFIT 2P</td> <td>1</td> <td>PZ</td> </tr> <tr> <td>CE1285A0</td> <td>FERRITE EMI ROUND MOD. 2643801502</td> <td>1</td> <td>PZ</td> </tr> <tr> <td>CE1290A0</td> <td>MORSETTO FEMMINA ESTRAIBILE CPF 5/4</td> <td>1</td> <td>PZ</td> </tr> <tr> <td>CE1455A0</td> <td>TERMINALE A PUNTALE</td> <td>4</td> <td>PZ</td> </tr> <tr> <td>CE1725A0</td> <td>CAVO SILICONICO PER ROBOTICA 4 X 0.5 MMO</td> <td>3</td> <td>M</td> </tr> <tr> <td>CE1735A0</td> <td>TERMINALE MINIFIT FEMMINA</td> <td>4</td> <td>PZ</td> </tr> <tr> <td>CE1755A0</td> <td>CONNETTORE MINIFIT MASCHIO 4 VI</td> <td>1</td> <td>PZ</td> </tr> </tbody> </table>	Codice	Descrizione	Qtà	UM	0B1206A0	COLONNINA ESTERNA DX PORTA 0511 LEFT	1	PZ	0B1216A0	TRAVERSO SUPERIORE PORTA 750 MM 2V	1	PZ	0B1217A0	TRAVERSO SUPERIORE INT PORTA 750 MM 2V	1	PZ	0B1217A1	TRAVERSO SUPERIORE INT PORTA 750 S6 2V	1	PZ	0H7321A0	PIASTRINA COPERCHIETT O MANIGLIA M	1	PZ	CE1052A0	CAVO CONNESSION E CONTROLLO- USB MM 650M	1	PZ	CE1052A1	CAVO CONNESSION E CONTROLLO- USB MM 750M	1	PZ	CE1053B0	CAVO ALIMENT BARRA LED MM MICROFIT 2P	1	PZ	CE1285A0	FERRITE EMI ROUND MOD. 2643801502	1	PZ	CE1290A0	MORSETTO FEMMINA ESTRAIBILE CPF 5/4	1	PZ	CE1455A0	TERMINALE A PUNTALE	4	PZ	CE1725A0	CAVO SILICONICO PER ROBOTICA 4 X 0.5 MMO	3	M	CE1735A0	TERMINALE MINIFIT FEMMINA	4	PZ	CE1755A0	CONNETTORE MINIFIT MASCHIO 4 VI	1	PZ
Codice	Descrizione	Qtà	UM																																																														
0B1206A0	COLONNINA ESTERNA DX PORTA 0511 LEFT	1	PZ																																																														
0B1216A0	TRAVERSO SUPERIORE PORTA 750 MM 2V	1	PZ																																																														
0B1217A0	TRAVERSO SUPERIORE INT PORTA 750 MM 2V	1	PZ																																																														
0B1217A1	TRAVERSO SUPERIORE INT PORTA 750 S6 2V	1	PZ																																																														
0H7321A0	PIASTRINA COPERCHIETT O MANIGLIA M	1	PZ																																																														
CE1052A0	CAVO CONNESSION E CONTROLLO- USB MM 650M	1	PZ																																																														
CE1052A1	CAVO CONNESSION E CONTROLLO- USB MM 750M	1	PZ																																																														
CE1053B0	CAVO ALIMENT BARRA LED MM MICROFIT 2P	1	PZ																																																														
CE1285A0	FERRITE EMI ROUND MOD. 2643801502	1	PZ																																																														
CE1290A0	MORSETTO FEMMINA ESTRAIBILE CPF 5/4	1	PZ																																																														
CE1455A0	TERMINALE A PUNTALE	4	PZ																																																														
CE1725A0	CAVO SILICONICO PER ROBOTICA 4 X 0.5 MMO	3	M																																																														
CE1735A0	TERMINALE MINIFIT FEMMINA	4	PZ																																																														
CE1755A0	CONNETTORE MINIFIT MASCHIO 4 VI	1	PZ																																																														

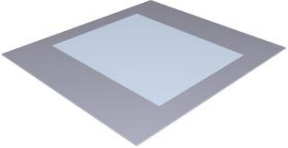
COMPONENTE			RICAMBIO																																																																						
Codice	Descrizione	Immagine	Codice	Descrizione	Lista componenti																																																																				
VT1276A	VETRO ESTERNO SER. XEVC-0511-E		KDR1265A	PORTA ESTERNA 0511 LEFT	<table border="1"> <thead> <tr> <th>Codice</th> <th>Descrizione</th> <th>Qtà</th> <th>UM</th> </tr> </thead> <tbody> <tr> <td>GN1525A0</td> <td>O-RING D.INT 9.5XSP 1 NBR 70</td> <td>1</td> <td>PZ</td> </tr> <tr> <td>IP1508A0</td> <td>POLISTIROLO PROFILO AD U 2000X60X60</td> <td>2</td> <td>PZ</td> </tr> <tr> <td>IP1508A1</td> <td>POLISTIROLO PROFILO AD U 2000X60X60</td> <td>2</td> <td>M</td> </tr> <tr> <td>LP1019A0</td> <td>BARRA ILLUMINAZION E LED MM L200 E415</td> <td>1</td> <td>PZ</td> </tr> <tr> <td>LP1025A0</td> <td>ESTRUSO ILLUMINAZION E NO LED MM L415</td> <td>1</td> <td>PZ</td> </tr> <tr> <td>RC1200A0</td> <td>MOLLA A COMPRESSIO NE DE4 DF0.5 H24</td> <td>4</td> <td>PZ</td> </tr> <tr> <td>SL1170A1</td> <td>SILICONE ANTRACITE S53 CARTUCCIA 310 ML</td> <td>21</td> <td>ML</td> </tr> <tr> <td>VE1030A1</td> <td>CALAMITA D=22,9MM PER MICROPORTA</td> <td>2</td> <td>PZ</td> </tr> <tr> <td>VI0239A1</td> <td>VITE AUTOFIL. 4.2X25 TCB+ INOX</td> <td>4</td> <td>PZ</td> </tr> <tr> <td>VI1034A0</td> <td>RONDELLA PIANA 8.4X16X1 INOX</td> <td>1</td> <td>PZ</td> </tr> <tr> <td>VI1220A1</td> <td>VITE AUTOFILETTA NTE 4.2X11 TCS+ MARUTE</td> <td>25</td> <td>PZ</td> </tr> <tr> <td>VI1930A0</td> <td>VITE 5X25 TRUCIOLARE INOX</td> <td>16</td> <td>PZ</td> </tr> <tr> <td>VI1996A0</td> <td>VITE M5X35 TCEI ZN</td> <td>13</td> <td>PZ</td> </tr> <tr> <td>VI2000A0</td> <td>VITE M4X22 TCB+ INOX</td> <td>2</td> <td>PZ</td> </tr> <tr> <td>VM1059A1</td> <td>FILM TERMORETRA IBILE H800</td> <td>1.500</td> <td>M</td> </tr> <tr> <td>VM1182B0</td> <td>ATTACCO MANIGLIA CON GUIDA PERNO CT BT</td> <td>1</td> <td>PZ</td> </tr> </tbody> </table>	Codice	Descrizione	Qtà	UM	GN1525A0	O-RING D.INT 9.5XSP 1 NBR 70	1	PZ	IP1508A0	POLISTIROLO PROFILO AD U 2000X60X60	2	PZ	IP1508A1	POLISTIROLO PROFILO AD U 2000X60X60	2	M	LP1019A0	BARRA ILLUMINAZION E LED MM L200 E415	1	PZ	LP1025A0	ESTRUSO ILLUMINAZION E NO LED MM L415	1	PZ	RC1200A0	MOLLA A COMPRESSIO NE DE4 DF0.5 H24	4	PZ	SL1170A1	SILICONE ANTRACITE S53 CARTUCCIA 310 ML	21	ML	VE1030A1	CALAMITA D=22,9MM PER MICROPORTA	2	PZ	VI0239A1	VITE AUTOFIL. 4.2X25 TCB+ INOX	4	PZ	VI1034A0	RONDELLA PIANA 8.4X16X1 INOX	1	PZ	VI1220A1	VITE AUTOFILETTA NTE 4.2X11 TCS+ MARUTE	25	PZ	VI1930A0	VITE 5X25 TRUCIOLARE INOX	16	PZ	VI1996A0	VITE M5X35 TCEI ZN	13	PZ	VI2000A0	VITE M4X22 TCB+ INOX	2	PZ	VM1059A1	FILM TERMORETRA IBILE H800	1.500	M	VM1182B0	ATTACCO MANIGLIA CON GUIDA PERNO CT BT	1	PZ
Codice	Descrizione	Qtà	UM																																																																						
GN1525A0	O-RING D.INT 9.5XSP 1 NBR 70	1	PZ																																																																						
IP1508A0	POLISTIROLO PROFILO AD U 2000X60X60	2	PZ																																																																						
IP1508A1	POLISTIROLO PROFILO AD U 2000X60X60	2	M																																																																						
LP1019A0	BARRA ILLUMINAZION E LED MM L200 E415	1	PZ																																																																						
LP1025A0	ESTRUSO ILLUMINAZION E NO LED MM L415	1	PZ																																																																						
RC1200A0	MOLLA A COMPRESSIO NE DE4 DF0.5 H24	4	PZ																																																																						
SL1170A1	SILICONE ANTRACITE S53 CARTUCCIA 310 ML	21	ML																																																																						
VE1030A1	CALAMITA D=22,9MM PER MICROPORTA	2	PZ																																																																						
VI0239A1	VITE AUTOFIL. 4.2X25 TCB+ INOX	4	PZ																																																																						
VI1034A0	RONDELLA PIANA 8.4X16X1 INOX	1	PZ																																																																						
VI1220A1	VITE AUTOFILETTA NTE 4.2X11 TCS+ MARUTE	25	PZ																																																																						
VI1930A0	VITE 5X25 TRUCIOLARE INOX	16	PZ																																																																						
VI1996A0	VITE M5X35 TCEI ZN	13	PZ																																																																						
VI2000A0	VITE M4X22 TCB+ INOX	2	PZ																																																																						
VM1059A1	FILM TERMORETRA IBILE H800	1.500	M																																																																						
VM1182B0	ATTACCO MANIGLIA CON GUIDA PERNO CT BT	1	PZ																																																																						

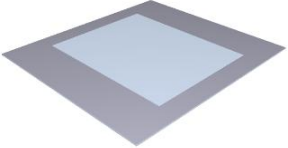
<b>COMPONENTE</b>			<b>RICAMBIO</b>																																																																						
<i>Codice</i>	<i>Descrizione</i>	<i>Immagine</i>	<i>Codice</i>	<i>Descrizione</i>	<i>Lista componenti</i>																																																																				
VT1276A	VETRO ESTERNO SER. XEVC-0511-E		KDR1265A	PORTA ESTERNA 0511 LEFT	<table border="1"> <thead> <tr> <th><i>Codice</i></th> <th><i>Descrizione</i></th> <th><i>Qtà</i></th> <th><i>UM</i></th> </tr> </thead> <tbody> <tr> <td>VM1182B1</td> <td>ATTACCO MANIGLIA CON GUIDA PERNO CT BT</td> <td>1</td> <td>PZ</td> </tr> <tr> <td>VM1183A1</td> <td>PERNO MANIGLIA CHEFTOP BAKERTOP</td> <td>1</td> <td>PZ</td> </tr> <tr> <td>VM1183B0</td> <td>PERNO MANIGLIA CT BT</td> <td>1</td> <td>PZ</td> </tr> <tr> <td>VM1490A0</td> <td>COPRI VITI MANIGLIA CHEFTOP BAKERTOP</td> <td>2</td> <td>PZ</td> </tr> <tr> <td>VM1630A0</td> <td>TAPPO PREMI VETRO INTERNO</td> <td>1</td> <td>PZ</td> </tr> <tr> <td>VM1695A0</td> <td>PERNO POSIZIONE MANIGLIA</td> <td>4</td> <td>PZ</td> </tr> <tr> <td>VM2245A0</td> <td>IMPUGNATUR A MANIGLIA CON SCROCC</td> <td>1</td> <td>PZ</td> </tr> <tr> <td>VM2247A0</td> <td>COVER IMPUGNATUR A MANIGLIA VM2245-2246</td> <td>1</td> <td>PZ</td> </tr> <tr> <td>VM2248A0</td> <td>CHIAVETTA CHIUSURA MANIGLIA CON SCROCC</td> <td>1</td> <td>PZ</td> </tr> <tr> <td>VM2248B0</td> <td>CHIAVETTA CHIUSURA MANIGLIA CON SCROCC</td> <td>1</td> <td>PZ</td> </tr> <tr> <td>VM2260A1</td> <td>TAPPO SUP SX PORTA S6</td> <td>1</td> <td>PZ</td> </tr> <tr> <td>VM2267A0</td> <td>CORSOIO SISTEMA FERMA VETRO INT</td> <td>2</td> <td>PZ</td> </tr> <tr> <td>VM2268A0</td> <td>TAPPO COPRI CALAMITA PORTA</td> <td>2</td> <td>PZ</td> </tr> <tr> <td>VM2269A0</td> <td>TAPPO SISTEMA FERMA VETRO INT</td> <td>2</td> <td>PZ</td> </tr> <tr> <td>VM2274A0</td> <td>BOCCOLA SCANALATA</td> <td>1</td> <td>PZ</td> </tr> <tr> <td>VM2275A0</td> <td>BOCCOLA LISCIA</td> <td>1</td> <td>PZ</td> </tr> </tbody> </table>	<i>Codice</i>	<i>Descrizione</i>	<i>Qtà</i>	<i>UM</i>	VM1182B1	ATTACCO MANIGLIA CON GUIDA PERNO CT BT	1	PZ	VM1183A1	PERNO MANIGLIA CHEFTOP BAKERTOP	1	PZ	VM1183B0	PERNO MANIGLIA CT BT	1	PZ	VM1490A0	COPRI VITI MANIGLIA CHEFTOP BAKERTOP	2	PZ	VM1630A0	TAPPO PREMI VETRO INTERNO	1	PZ	VM1695A0	PERNO POSIZIONE MANIGLIA	4	PZ	VM2245A0	IMPUGNATUR A MANIGLIA CON SCROCC	1	PZ	VM2247A0	COVER IMPUGNATUR A MANIGLIA VM2245-2246	1	PZ	VM2248A0	CHIAVETTA CHIUSURA MANIGLIA CON SCROCC	1	PZ	VM2248B0	CHIAVETTA CHIUSURA MANIGLIA CON SCROCC	1	PZ	VM2260A1	TAPPO SUP SX PORTA S6	1	PZ	VM2267A0	CORSOIO SISTEMA FERMA VETRO INT	2	PZ	VM2268A0	TAPPO COPRI CALAMITA PORTA	2	PZ	VM2269A0	TAPPO SISTEMA FERMA VETRO INT	2	PZ	VM2274A0	BOCCOLA SCANALATA	1	PZ	VM2275A0	BOCCOLA LISCIA	1	PZ
<i>Codice</i>	<i>Descrizione</i>	<i>Qtà</i>	<i>UM</i>																																																																						
VM1182B1	ATTACCO MANIGLIA CON GUIDA PERNO CT BT	1	PZ																																																																						
VM1183A1	PERNO MANIGLIA CHEFTOP BAKERTOP	1	PZ																																																																						
VM1183B0	PERNO MANIGLIA CT BT	1	PZ																																																																						
VM1490A0	COPRI VITI MANIGLIA CHEFTOP BAKERTOP	2	PZ																																																																						
VM1630A0	TAPPO PREMI VETRO INTERNO	1	PZ																																																																						
VM1695A0	PERNO POSIZIONE MANIGLIA	4	PZ																																																																						
VM2245A0	IMPUGNATUR A MANIGLIA CON SCROCC	1	PZ																																																																						
VM2247A0	COVER IMPUGNATUR A MANIGLIA VM2245-2246	1	PZ																																																																						
VM2248A0	CHIAVETTA CHIUSURA MANIGLIA CON SCROCC	1	PZ																																																																						
VM2248B0	CHIAVETTA CHIUSURA MANIGLIA CON SCROCC	1	PZ																																																																						
VM2260A1	TAPPO SUP SX PORTA S6	1	PZ																																																																						
VM2267A0	CORSOIO SISTEMA FERMA VETRO INT	2	PZ																																																																						
VM2268A0	TAPPO COPRI CALAMITA PORTA	2	PZ																																																																						
VM2269A0	TAPPO SISTEMA FERMA VETRO INT	2	PZ																																																																						
VM2274A0	BOCCOLA SCANALATA	1	PZ																																																																						
VM2275A0	BOCCOLA LISCIA	1	PZ																																																																						

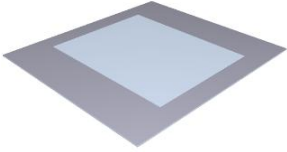
COMPONENTE			RICAMBIO																																																																								
Codice	Descrizione	Immagine	Codice	Descrizione	Lista componenti																																																																						
VT1276A	VETRO ESTERNO SER. XEVC-0511-E		KDR1265A	PORTA ESTERNA 0511 LEFT	<table border="1"> <thead> <tr> <th>Codice</th> <th>Descrizione</th> <th>Qtà</th> <th>UM</th> </tr> </thead> <tbody> <tr> <td>VM2284A0</td> <td>PROFILO SALVAGOCCE SERIE 750</td> <td>1</td> <td>PZ</td> </tr> <tr> <td>VM2295A0</td> <td>PENNINO PER CONTROLLO MM</td> <td>1</td> <td>PZ</td> </tr> <tr> <td>VM2305A0</td> <td>NOTTOLINO FISSAGGIO TAPPI PORTE MM</td> <td>14</td> <td>PZ</td> </tr> <tr> <td>VM2312A0</td> <td>TUBETTO SX SCARICO GOCCIOLATOI O MM</td> <td>1</td> <td>PZ</td> </tr> <tr> <td>VM2313A0</td> <td>TUBETTO DX SCARICO GOCCIOLATOI O MM</td> <td>1</td> <td>PZ</td> </tr> <tr> <td>VM2314A0</td> <td>TAPPINO GOCCIOLATOI O MM</td> <td>2</td> <td>PZ</td> </tr> <tr> <td>VM2315A0</td> <td>SUPPORTO SPINGI VETRO INT MM</td> <td>1</td> <td>PZ</td> </tr> <tr> <td>VM2316A0</td> <td>SUPPORTO VENTOLA RAFF. CRUSCOTTO</td> <td>1</td> <td>PZ</td> </tr> <tr> <td>VM2371A0</td> <td>SPINGIVETRO PORTE DOPPIO VETR</td> <td>1</td> <td>PZ</td> </tr> <tr> <td>VM2383A0</td> <td>TAPPO SUP DX PORTA MM LEFT</td> <td>1</td> <td>PZ</td> </tr> <tr> <td>VM2385A1</td> <td>TAPPO SUP SX PORTA MM LEFT</td> <td>1</td> <td>PZ</td> </tr> <tr> <td>VM2386A1</td> <td>TAPPO INF SX PORTA MM LEFT</td> <td>1</td> <td>PZ</td> </tr> <tr> <td>VM2518A0</td> <td>SUPPORTO VENTOLA RAFF CRUS 20X20 H20</td> <td>1</td> <td>PZ</td> </tr> <tr> <td>VN1177A0</td> <td>VENTIL ASSIALE 40X40X10MM 12VCC</td> <td>1</td> <td>PZ</td> </tr> <tr> <td>VN1179A0</td> <td>VENTIL ASSIALE 40X40X20MM 12VCC</td> <td>1</td> <td>PZ</td> </tr> <tr> <td>VT1276A0</td> <td>VETRO ESTERNO SER. XEVC-0511-E</td> <td></td> <td></td> <td>1</td> <td>PZ</td> </tr> </tbody> </table>	Codice	Descrizione	Qtà	UM	VM2284A0	PROFILO SALVAGOCCE SERIE 750	1	PZ	VM2295A0	PENNINO PER CONTROLLO MM	1	PZ	VM2305A0	NOTTOLINO FISSAGGIO TAPPI PORTE MM	14	PZ	VM2312A0	TUBETTO SX SCARICO GOCCIOLATOI O MM	1	PZ	VM2313A0	TUBETTO DX SCARICO GOCCIOLATOI O MM	1	PZ	VM2314A0	TAPPINO GOCCIOLATOI O MM	2	PZ	VM2315A0	SUPPORTO SPINGI VETRO INT MM	1	PZ	VM2316A0	SUPPORTO VENTOLA RAFF. CRUSCOTTO	1	PZ	VM2371A0	SPINGIVETRO PORTE DOPPIO VETR	1	PZ	VM2383A0	TAPPO SUP DX PORTA MM LEFT	1	PZ	VM2385A1	TAPPO SUP SX PORTA MM LEFT	1	PZ	VM2386A1	TAPPO INF SX PORTA MM LEFT	1	PZ	VM2518A0	SUPPORTO VENTOLA RAFF CRUS 20X20 H20	1	PZ	VN1177A0	VENTIL ASSIALE 40X40X10MM 12VCC	1	PZ	VN1179A0	VENTIL ASSIALE 40X40X20MM 12VCC	1	PZ	VT1276A0	VETRO ESTERNO SER. XEVC-0511-E			1	PZ
Codice	Descrizione	Qtà	UM																																																																								
VM2284A0	PROFILO SALVAGOCCE SERIE 750	1	PZ																																																																								
VM2295A0	PENNINO PER CONTROLLO MM	1	PZ																																																																								
VM2305A0	NOTTOLINO FISSAGGIO TAPPI PORTE MM	14	PZ																																																																								
VM2312A0	TUBETTO SX SCARICO GOCCIOLATOI O MM	1	PZ																																																																								
VM2313A0	TUBETTO DX SCARICO GOCCIOLATOI O MM	1	PZ																																																																								
VM2314A0	TAPPINO GOCCIOLATOI O MM	2	PZ																																																																								
VM2315A0	SUPPORTO SPINGI VETRO INT MM	1	PZ																																																																								
VM2316A0	SUPPORTO VENTOLA RAFF. CRUSCOTTO	1	PZ																																																																								
VM2371A0	SPINGIVETRO PORTE DOPPIO VETR	1	PZ																																																																								
VM2383A0	TAPPO SUP DX PORTA MM LEFT	1	PZ																																																																								
VM2385A1	TAPPO SUP SX PORTA MM LEFT	1	PZ																																																																								
VM2386A1	TAPPO INF SX PORTA MM LEFT	1	PZ																																																																								
VM2518A0	SUPPORTO VENTOLA RAFF CRUS 20X20 H20	1	PZ																																																																								
VN1177A0	VENTIL ASSIALE 40X40X10MM 12VCC	1	PZ																																																																								
VN1179A0	VENTIL ASSIALE 40X40X20MM 12VCC	1	PZ																																																																								
VT1276A0	VETRO ESTERNO SER. XEVC-0511-E			1	PZ																																																																						

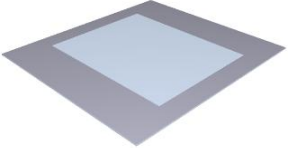
COMPONENTE			RICAMBIO																																																														
Codice	Descrizione	Immagine	Codice	Descrizione	Lista componenti																																																												
VT1276A	VETRO ESTERNO SER. XEVC-0511-E		KDR1261A	PORTA ESTERNA 0511 RIGHT	<table border="1"> <thead> <tr> <th>Codice</th> <th>Descrizione</th> <th>Qtà</th> <th>UM</th> </tr> </thead> <tbody> <tr> <td>0B1106A0</td> <td>COLONNINA ESTERNA SX PORTA XEVC-0511-E</td> <td>1</td> <td>PZ</td> </tr> <tr> <td>0B1107A0</td> <td>COLONNINA INTERNA SX PORTA XEVC-0511-E</td> <td>1</td> <td>PZ</td> </tr> <tr> <td>0B1107A1</td> <td>COLONNINA INTERNA SX PORTA XEVC-0511-E</td> <td>1</td> <td>PZ</td> </tr> <tr> <td>0B1108A0</td> <td>COLONNINA ESTERNA DX PORTA XEVC-0511-E</td> <td>1</td> <td>PZ</td> </tr> <tr> <td>0B1109A0</td> <td>COLONNINA INTERNA DX PORTA XEVC-0511-E</td> <td>1</td> <td>PZ</td> </tr> <tr> <td>0B1109A1</td> <td>COLONNINA INTERNA DX PORTA XEVC-0511-E</td> <td>1</td> <td>PZ</td> </tr> <tr> <td>0B1122A0</td> <td>TRAVERSO INFERIORE PORTA 750 M</td> <td>1</td> <td>PZ</td> </tr> <tr> <td>0B1166A0</td> <td>PROFILO SUPPORTO VETRO ESTERNO</td> <td>2</td> <td>PZ</td> </tr> <tr> <td>0B1216A0</td> <td>TRAVERSO SUPERIORE PORTA 750 MM 2V</td> <td>1</td> <td>PZ</td> </tr> <tr> <td>0B1217A0</td> <td>TRAVERSO SUPERIORE INT PORTA 750 MM 2V</td> <td>1</td> <td>PZ</td> </tr> <tr> <td>0B1217A1</td> <td>TRAVERSO SUPERIORE INT PORTA 750 S6 2V</td> <td>1</td> <td>PZ</td> </tr> <tr> <td>0B1245A0</td> <td>COLONNINA ESTERNA SX PORTA 0511 E</td> <td>1</td> <td>PZ</td> </tr> <tr> <td>0H7321A0</td> <td>PIASTRINA COPERCHIETT O MANIGLIA M</td> <td>1</td> <td>PZ</td> </tr> <tr> <td>CE1052A0</td> <td>CAVO CONNESSION E CONTROLLO- USB MM 650M</td> <td>1</td> <td>PZ</td> </tr> </tbody> </table>	Codice	Descrizione	Qtà	UM	0B1106A0	COLONNINA ESTERNA SX PORTA XEVC-0511-E	1	PZ	0B1107A0	COLONNINA INTERNA SX PORTA XEVC-0511-E	1	PZ	0B1107A1	COLONNINA INTERNA SX PORTA XEVC-0511-E	1	PZ	0B1108A0	COLONNINA ESTERNA DX PORTA XEVC-0511-E	1	PZ	0B1109A0	COLONNINA INTERNA DX PORTA XEVC-0511-E	1	PZ	0B1109A1	COLONNINA INTERNA DX PORTA XEVC-0511-E	1	PZ	0B1122A0	TRAVERSO INFERIORE PORTA 750 M	1	PZ	0B1166A0	PROFILO SUPPORTO VETRO ESTERNO	2	PZ	0B1216A0	TRAVERSO SUPERIORE PORTA 750 MM 2V	1	PZ	0B1217A0	TRAVERSO SUPERIORE INT PORTA 750 MM 2V	1	PZ	0B1217A1	TRAVERSO SUPERIORE INT PORTA 750 S6 2V	1	PZ	0B1245A0	COLONNINA ESTERNA SX PORTA 0511 E	1	PZ	0H7321A0	PIASTRINA COPERCHIETT O MANIGLIA M	1	PZ	CE1052A0	CAVO CONNESSION E CONTROLLO- USB MM 650M	1	PZ
Codice	Descrizione	Qtà	UM																																																														
0B1106A0	COLONNINA ESTERNA SX PORTA XEVC-0511-E	1	PZ																																																														
0B1107A0	COLONNINA INTERNA SX PORTA XEVC-0511-E	1	PZ																																																														
0B1107A1	COLONNINA INTERNA SX PORTA XEVC-0511-E	1	PZ																																																														
0B1108A0	COLONNINA ESTERNA DX PORTA XEVC-0511-E	1	PZ																																																														
0B1109A0	COLONNINA INTERNA DX PORTA XEVC-0511-E	1	PZ																																																														
0B1109A1	COLONNINA INTERNA DX PORTA XEVC-0511-E	1	PZ																																																														
0B1122A0	TRAVERSO INFERIORE PORTA 750 M	1	PZ																																																														
0B1166A0	PROFILO SUPPORTO VETRO ESTERNO	2	PZ																																																														
0B1216A0	TRAVERSO SUPERIORE PORTA 750 MM 2V	1	PZ																																																														
0B1217A0	TRAVERSO SUPERIORE INT PORTA 750 MM 2V	1	PZ																																																														
0B1217A1	TRAVERSO SUPERIORE INT PORTA 750 S6 2V	1	PZ																																																														
0B1245A0	COLONNINA ESTERNA SX PORTA 0511 E	1	PZ																																																														
0H7321A0	PIASTRINA COPERCHIETT O MANIGLIA M	1	PZ																																																														
CE1052A0	CAVO CONNESSION E CONTROLLO- USB MM 650M	1	PZ																																																														

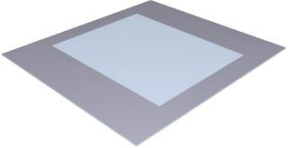

COMPONENTE			RICAMBIO																																																														
Codice	Descrizione	Immagine	Codice	Descrizione	Lista componenti																																																												
VT1276A	VETRO ESTERNO SER. XEVC-0511-E		KDR1261A	PORTA ESTERNA 0511 RIGHT	<table border="1"> <thead> <tr> <th>Codice</th> <th>Descrizione</th> <th>Qtà</th> <th>UM</th> </tr> </thead> <tbody> <tr> <td>CE1052A1</td> <td>CAVO CONNESSION E CONTROLLO- USB MM 750M</td> <td>1</td> <td>PZ</td> </tr> <tr> <td>CE1053B0</td> <td>CAVO ALIMENT BARRA LED MM MICROFIT 2P</td> <td>1</td> <td>PZ</td> </tr> <tr> <td>CE1285A0</td> <td>FERRITE EMI ROUND MOD. 2643801502</td> <td>1</td> <td>PZ</td> </tr> <tr> <td>CE1290A0</td> <td>MORSETTO FEMMINA ESTRAIBILE CPF 5/4</td> <td>1</td> <td>PZ</td> </tr> <tr> <td>CE1455A0</td> <td>TERMINALE A PUNTALE</td> <td>4</td> <td>PZ</td> </tr> <tr> <td>CE1725A0</td> <td>CAVO SILICONICO PER ROBOTICA 4 X 0.5 MMQ</td> <td>3</td> <td>M</td> </tr> <tr> <td>CE1735A0</td> <td>TERMINALE MINIFIT FEMMINA</td> <td>4</td> <td>PZ</td> </tr> <tr> <td>CE1755A0</td> <td>CONNETTORE MINIFIT MASCHIO 4 VI</td> <td>1</td> <td>PZ</td> </tr> <tr> <td>GN1525A0</td> <td>O-RING D.INT 9.5XSP 1 NBR 70</td> <td>1</td> <td>PZ</td> </tr> <tr> <td>IP1508A0</td> <td>POLISTIROLO PROFILO AD U 2000X60X60</td> <td>2</td> <td>PZ</td> </tr> <tr> <td>IP1508A1</td> <td>POLISTIROLO PROFILO AD U 2000X60X60</td> <td>2</td> <td>M</td> </tr> <tr> <td>LP1019A0</td> <td>BARRA ILLUMINAZION E LED MM L200 E415</td> <td>1</td> <td>PZ</td> </tr> <tr> <td>LP1025A0</td> <td>ESTRUSO ILLUMINAZION E NO LED MM L415</td> <td>1</td> <td>PZ</td> </tr> <tr> <td>RC1200A0</td> <td>MOLLA A COMPRESSIO NE DE4 DF0.5 H24</td> <td>4</td> <td>PZ</td> </tr> </tbody> </table>	Codice	Descrizione	Qtà	UM	CE1052A1	CAVO CONNESSION E CONTROLLO- USB MM 750M	1	PZ	CE1053B0	CAVO ALIMENT BARRA LED MM MICROFIT 2P	1	PZ	CE1285A0	FERRITE EMI ROUND MOD. 2643801502	1	PZ	CE1290A0	MORSETTO FEMMINA ESTRAIBILE CPF 5/4	1	PZ	CE1455A0	TERMINALE A PUNTALE	4	PZ	CE1725A0	CAVO SILICONICO PER ROBOTICA 4 X 0.5 MMQ	3	M	CE1735A0	TERMINALE MINIFIT FEMMINA	4	PZ	CE1755A0	CONNETTORE MINIFIT MASCHIO 4 VI	1	PZ	GN1525A0	O-RING D.INT 9.5XSP 1 NBR 70	1	PZ	IP1508A0	POLISTIROLO PROFILO AD U 2000X60X60	2	PZ	IP1508A1	POLISTIROLO PROFILO AD U 2000X60X60	2	M	LP1019A0	BARRA ILLUMINAZION E LED MM L200 E415	1	PZ	LP1025A0	ESTRUSO ILLUMINAZION E NO LED MM L415	1	PZ	RC1200A0	MOLLA A COMPRESSIO NE DE4 DF0.5 H24	4	PZ
Codice	Descrizione	Qtà	UM																																																														
CE1052A1	CAVO CONNESSION E CONTROLLO- USB MM 750M	1	PZ																																																														
CE1053B0	CAVO ALIMENT BARRA LED MM MICROFIT 2P	1	PZ																																																														
CE1285A0	FERRITE EMI ROUND MOD. 2643801502	1	PZ																																																														
CE1290A0	MORSETTO FEMMINA ESTRAIBILE CPF 5/4	1	PZ																																																														
CE1455A0	TERMINALE A PUNTALE	4	PZ																																																														
CE1725A0	CAVO SILICONICO PER ROBOTICA 4 X 0.5 MMQ	3	M																																																														
CE1735A0	TERMINALE MINIFIT FEMMINA	4	PZ																																																														
CE1755A0	CONNETTORE MINIFIT MASCHIO 4 VI	1	PZ																																																														
GN1525A0	O-RING D.INT 9.5XSP 1 NBR 70	1	PZ																																																														
IP1508A0	POLISTIROLO PROFILO AD U 2000X60X60	2	PZ																																																														
IP1508A1	POLISTIROLO PROFILO AD U 2000X60X60	2	M																																																														
LP1019A0	BARRA ILLUMINAZION E LED MM L200 E415	1	PZ																																																														
LP1025A0	ESTRUSO ILLUMINAZION E NO LED MM L415	1	PZ																																																														
RC1200A0	MOLLA A COMPRESSIO NE DE4 DF0.5 H24	4	PZ																																																														

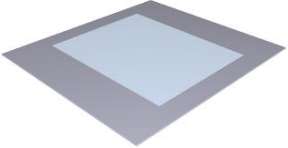

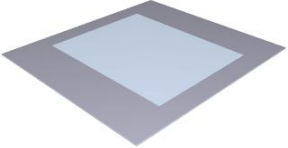

COMPONENTE			RICAMBIO																																																																						
Codice	Descrizione	Immagine	Codice	Descrizione	Lista componenti																																																																				
VT1276A	VETRO ESTERNO SER. XEVC-0511-E		KDR1261A	PORTA ESTERNA 0511 RIGHT	<table border="1"> <thead> <tr> <th>Codice</th> <th>Descrizione</th> <th>Qtà</th> <th>UM</th> </tr> </thead> <tbody> <tr> <td>SL1170A1</td> <td>SILICONE ANTRACITE S53 CARTUCCIA 310 ML</td> <td>30</td> <td>ML</td> </tr> <tr> <td>VE1030A1</td> <td>CALAMITA D=22,9MM PER MICROPORTA</td> <td>2</td> <td>PZ</td> </tr> <tr> <td>VI0239A1</td> <td>VITE AUTOFIL. 4.2X25 TCB+ INOX</td> <td>4</td> <td>PZ</td> </tr> <tr> <td>VI1034A0</td> <td>RONDELLA PIANA 8.4X16X1 INOX</td> <td>1</td> <td>PZ</td> </tr> <tr> <td>VI1220A1</td> <td>VITE AUTOFILETTA NTE 4.2X11 TCS+ MARUTE</td> <td>27</td> <td>PZ</td> </tr> <tr> <td>VI1930A0</td> <td>VITE 5X25 TRUCIOLARE INOX</td> <td>16</td> <td>PZ</td> </tr> <tr> <td>VI1996A0</td> <td>VITE M5X35 TCEI ZN</td> <td>13</td> <td>PZ</td> </tr> <tr> <td>VI2000A0</td> <td>VITE M4X22 TCB+ INOX</td> <td>2</td> <td>PZ</td> </tr> <tr> <td>VM1059A1</td> <td>FILM TERMORETRA IBILE H800</td> <td>1</td> <td>M</td> </tr> <tr> <td>VM1182B0</td> <td>ATTACCO MANIGLIA CON GUIDA PERNO CT BT</td> <td>1</td> <td>PZ</td> </tr> <tr> <td>VM1182B1</td> <td>ATTACCO MANIGLIA CON GUIDA PERNO CT BT</td> <td>1</td> <td>PZ</td> </tr> <tr> <td>VM1183A1</td> <td>PERNO MANIGLIA CHEFTOP BAKERTOP</td> <td>1</td> <td>PZ</td> </tr> <tr> <td>VM1183B0</td> <td>PERNO MANIGLIA CT BT</td> <td>1</td> <td>PZ</td> </tr> <tr> <td>VM1490A0</td> <td>COPRI VITI MANIGLIA CHEFTOP BAKERTOP</td> <td>2</td> <td>PZ</td> </tr> <tr> <td>VM1630A0</td> <td>TAPPO PREMI VETRO INTERNO</td> <td>3</td> <td>PZ</td> </tr> <tr> <td>VM1695A0</td> <td>PERNO POSIZIONE MANIGLIA</td> <td>4</td> <td>PZ</td> </tr> </tbody> </table>	Codice	Descrizione	Qtà	UM	SL1170A1	SILICONE ANTRACITE S53 CARTUCCIA 310 ML	30	ML	VE1030A1	CALAMITA D=22,9MM PER MICROPORTA	2	PZ	VI0239A1	VITE AUTOFIL. 4.2X25 TCB+ INOX	4	PZ	VI1034A0	RONDELLA PIANA 8.4X16X1 INOX	1	PZ	VI1220A1	VITE AUTOFILETTA NTE 4.2X11 TCS+ MARUTE	27	PZ	VI1930A0	VITE 5X25 TRUCIOLARE INOX	16	PZ	VI1996A0	VITE M5X35 TCEI ZN	13	PZ	VI2000A0	VITE M4X22 TCB+ INOX	2	PZ	VM1059A1	FILM TERMORETRA IBILE H800	1	M	VM1182B0	ATTACCO MANIGLIA CON GUIDA PERNO CT BT	1	PZ	VM1182B1	ATTACCO MANIGLIA CON GUIDA PERNO CT BT	1	PZ	VM1183A1	PERNO MANIGLIA CHEFTOP BAKERTOP	1	PZ	VM1183B0	PERNO MANIGLIA CT BT	1	PZ	VM1490A0	COPRI VITI MANIGLIA CHEFTOP BAKERTOP	2	PZ	VM1630A0	TAPPO PREMI VETRO INTERNO	3	PZ	VM1695A0	PERNO POSIZIONE MANIGLIA	4	PZ
Codice	Descrizione	Qtà	UM																																																																						
SL1170A1	SILICONE ANTRACITE S53 CARTUCCIA 310 ML	30	ML																																																																						
VE1030A1	CALAMITA D=22,9MM PER MICROPORTA	2	PZ																																																																						
VI0239A1	VITE AUTOFIL. 4.2X25 TCB+ INOX	4	PZ																																																																						
VI1034A0	RONDELLA PIANA 8.4X16X1 INOX	1	PZ																																																																						
VI1220A1	VITE AUTOFILETTA NTE 4.2X11 TCS+ MARUTE	27	PZ																																																																						
VI1930A0	VITE 5X25 TRUCIOLARE INOX	16	PZ																																																																						
VI1996A0	VITE M5X35 TCEI ZN	13	PZ																																																																						
VI2000A0	VITE M4X22 TCB+ INOX	2	PZ																																																																						
VM1059A1	FILM TERMORETRA IBILE H800	1	M																																																																						
VM1182B0	ATTACCO MANIGLIA CON GUIDA PERNO CT BT	1	PZ																																																																						
VM1182B1	ATTACCO MANIGLIA CON GUIDA PERNO CT BT	1	PZ																																																																						
VM1183A1	PERNO MANIGLIA CHEFTOP BAKERTOP	1	PZ																																																																						
VM1183B0	PERNO MANIGLIA CT BT	1	PZ																																																																						
VM1490A0	COPRI VITI MANIGLIA CHEFTOP BAKERTOP	2	PZ																																																																						
VM1630A0	TAPPO PREMI VETRO INTERNO	3	PZ																																																																						
VM1695A0	PERNO POSIZIONE MANIGLIA	4	PZ																																																																						

COMPONENTE			RICAMBIO																																																																														
Codice	Descrizione	Immagine	Codice	Descrizione	Lista componenti																																																																												
VT1276A	VETRO ESTERNO SER. XEVC-0511-E		KDR1261A	PORTA ESTERNA 0511 RIGHT	<table border="1"> <thead> <tr> <th>Codice</th> <th>Descrizione</th> <th>Qtà</th> <th>UM</th> </tr> </thead> <tbody> <tr> <td>VM2245A0</td> <td>IMPUGNATUR A MANIGLIA CON SCROCC</td> <td>1</td> <td>PZ</td> </tr> <tr> <td>VM2247A0</td> <td>COVER IMPUGNATUR A MANIGLIA VM2245-2246</td> <td>1</td> <td>PZ</td> </tr> <tr> <td>VM2248A0</td> <td>CHIAVETTA CHIUSURA MANIGLIA CON SCROCC</td> <td>1</td> <td>PZ</td> </tr> <tr> <td>VM2248B0</td> <td>CHIAVETTA CHIUSURA MANIGLIA CON SCROCC</td> <td>1</td> <td>PZ</td> </tr> <tr> <td>VM2259A1</td> <td>TAPPO INF SX PORTA S6</td> <td>1</td> <td>PZ</td> </tr> <tr> <td>VM2260A1</td> <td>TAPPO SUP SX PORTA S6</td> <td>1</td> <td>PZ</td> </tr> <tr> <td>VM2261A1</td> <td>TAPPO INF DX PORTA S6</td> <td>1</td> <td>PZ</td> </tr> <tr> <td>VM2262A1</td> <td>TAPPO SUP DX PORTA S6</td> <td>1</td> <td>PZ</td> </tr> <tr> <td>VM2267A0</td> <td>CORSOIO SISTEMA FERMA VETRO INT</td> <td>2</td> <td>PZ</td> </tr> <tr> <td>VM2268A0</td> <td>TAPPO COPRI CALAMITA PORTA</td> <td>2</td> <td>PZ</td> </tr> <tr> <td>VM2269A0</td> <td>TAPPO SISTEMA FERMA VETRO INT</td> <td>2</td> <td>PZ</td> </tr> <tr> <td>VM2274A0</td> <td>BOCCOLA SCANALATA</td> <td>1</td> <td>PZ</td> </tr> <tr> <td>VM2275A0</td> <td>BOCCOLA LISCIA</td> <td>1</td> <td>PZ</td> </tr> <tr> <td>VM2284A0</td> <td>PROFILO SALVAGOCCE SERIE 750</td> <td>1</td> <td>PZ</td> </tr> <tr> <td>VM2295A0</td> <td>PENNINO PER CONTROLLO MM</td> <td>1</td> <td>PZ</td> </tr> <tr> <td>VM2305A0</td> <td>NOTTOLINO FISSAGGIO TAPPI PORTE MM</td> <td>14</td> <td>PZ</td> </tr> <tr> <td>VM2312A0</td> <td>TUBETTO SX SCARICO GOCCIOLATOI O MM</td> <td>1</td> <td>PZ</td> </tr> <tr> <td>VM2314A0</td> <td>TAPPINO GOCCIOLATOI O MM</td> <td>2</td> <td>PZ</td> </tr> </tbody> </table>	Codice	Descrizione	Qtà	UM	VM2245A0	IMPUGNATUR A MANIGLIA CON SCROCC	1	PZ	VM2247A0	COVER IMPUGNATUR A MANIGLIA VM2245-2246	1	PZ	VM2248A0	CHIAVETTA CHIUSURA MANIGLIA CON SCROCC	1	PZ	VM2248B0	CHIAVETTA CHIUSURA MANIGLIA CON SCROCC	1	PZ	VM2259A1	TAPPO INF SX PORTA S6	1	PZ	VM2260A1	TAPPO SUP SX PORTA S6	1	PZ	VM2261A1	TAPPO INF DX PORTA S6	1	PZ	VM2262A1	TAPPO SUP DX PORTA S6	1	PZ	VM2267A0	CORSOIO SISTEMA FERMA VETRO INT	2	PZ	VM2268A0	TAPPO COPRI CALAMITA PORTA	2	PZ	VM2269A0	TAPPO SISTEMA FERMA VETRO INT	2	PZ	VM2274A0	BOCCOLA SCANALATA	1	PZ	VM2275A0	BOCCOLA LISCIA	1	PZ	VM2284A0	PROFILO SALVAGOCCE SERIE 750	1	PZ	VM2295A0	PENNINO PER CONTROLLO MM	1	PZ	VM2305A0	NOTTOLINO FISSAGGIO TAPPI PORTE MM	14	PZ	VM2312A0	TUBETTO SX SCARICO GOCCIOLATOI O MM	1	PZ	VM2314A0	TAPPINO GOCCIOLATOI O MM	2	PZ
Codice	Descrizione	Qtà	UM																																																																														
VM2245A0	IMPUGNATUR A MANIGLIA CON SCROCC	1	PZ																																																																														
VM2247A0	COVER IMPUGNATUR A MANIGLIA VM2245-2246	1	PZ																																																																														
VM2248A0	CHIAVETTA CHIUSURA MANIGLIA CON SCROCC	1	PZ																																																																														
VM2248B0	CHIAVETTA CHIUSURA MANIGLIA CON SCROCC	1	PZ																																																																														
VM2259A1	TAPPO INF SX PORTA S6	1	PZ																																																																														
VM2260A1	TAPPO SUP SX PORTA S6	1	PZ																																																																														
VM2261A1	TAPPO INF DX PORTA S6	1	PZ																																																																														
VM2262A1	TAPPO SUP DX PORTA S6	1	PZ																																																																														
VM2267A0	CORSOIO SISTEMA FERMA VETRO INT	2	PZ																																																																														
VM2268A0	TAPPO COPRI CALAMITA PORTA	2	PZ																																																																														
VM2269A0	TAPPO SISTEMA FERMA VETRO INT	2	PZ																																																																														
VM2274A0	BOCCOLA SCANALATA	1	PZ																																																																														
VM2275A0	BOCCOLA LISCIA	1	PZ																																																																														
VM2284A0	PROFILO SALVAGOCCE SERIE 750	1	PZ																																																																														
VM2295A0	PENNINO PER CONTROLLO MM	1	PZ																																																																														
VM2305A0	NOTTOLINO FISSAGGIO TAPPI PORTE MM	14	PZ																																																																														
VM2312A0	TUBETTO SX SCARICO GOCCIOLATOI O MM	1	PZ																																																																														
VM2314A0	TAPPINO GOCCIOLATOI O MM	2	PZ																																																																														

COMPONENTE			RICAMBIO																																		
Codice	Descrizione	Immagine	Codice	Descrizione	Lista componenti																																
VT1276A	VETRO ESTERNO SER. XEVC-0511-E		KDR1261A	PORTA ESTERNA 0511 RIGHT	<table border="1"> <thead> <tr> <th>Codice</th> <th>Descrizione</th> <th>Qtà</th> <th>UM</th> </tr> </thead> <tbody> <tr> <td>VM2315A0</td> <td>SUPPORTO SPINGI VETRO INT MM</td> <td>3</td> <td>PZ</td> </tr> <tr> <td>VM2316A0</td> <td>SUPPORTO VENTOLA RAFF. CRUSCOTTO</td> <td>1</td> <td>PZ</td> </tr> <tr> <td>VM2371A0</td> <td>SPINGIVETRO PORTE DOPPIO VETR</td> <td>3</td> <td>PZ</td> </tr> <tr> <td>VM2518A0</td> <td>SUPPORTO VENTOLA RAFF CRUS 20X20 H20</td> <td>1</td> <td>PZ</td> </tr> <tr> <td>VN1177A0</td> <td>VENTIL ASSIALE 40X40X10MM 12VCC</td> <td>1</td> <td>PZ</td> </tr> <tr> <td>VN1179A0</td> <td>VENTIL ASSIALE 40X40X20MM 12VCC</td> <td>1</td> <td>PZ</td> </tr> <tr> <td>VT1276A0</td> <td>VETRO ESTERNO SER. XEVC-0511-E</td> <td>1</td> <td>PZ</td> </tr> </tbody> </table>	Codice	Descrizione	Qtà	UM	VM2315A0	SUPPORTO SPINGI VETRO INT MM	3	PZ	VM2316A0	SUPPORTO VENTOLA RAFF. CRUSCOTTO	1	PZ	VM2371A0	SPINGIVETRO PORTE DOPPIO VETR	3	PZ	VM2518A0	SUPPORTO VENTOLA RAFF CRUS 20X20 H20	1	PZ	VN1177A0	VENTIL ASSIALE 40X40X10MM 12VCC	1	PZ	VN1179A0	VENTIL ASSIALE 40X40X20MM 12VCC	1	PZ	VT1276A0	VETRO ESTERNO SER. XEVC-0511-E	1	PZ
Codice	Descrizione	Qtà	UM																																		
VM2315A0	SUPPORTO SPINGI VETRO INT MM	3	PZ																																		
VM2316A0	SUPPORTO VENTOLA RAFF. CRUSCOTTO	1	PZ																																		
VM2371A0	SPINGIVETRO PORTE DOPPIO VETR	3	PZ																																		
VM2518A0	SUPPORTO VENTOLA RAFF CRUS 20X20 H20	1	PZ																																		
VN1177A0	VENTIL ASSIALE 40X40X10MM 12VCC	1	PZ																																		
VN1179A0	VENTIL ASSIALE 40X40X20MM 12VCC	1	PZ																																		
VT1276A0	VETRO ESTERNO SER. XEVC-0511-E	1	PZ																																		
MG1083A	ASSIEME MANIGLIA COMPLETO MM		KMG1083A	KIT MANIGLIA COMPLETA MM	<table border="1"> <thead> <tr> <th>Codice</th> <th>Descrizione</th> <th>Qtà</th> <th>UM</th> </tr> </thead> <tbody> <tr> <td>0H7321A0</td> <td>PIASTRINA COPERCHIETT O MANIGLIA M</td> <td>1</td> <td>PZ</td> </tr> <tr> <td>RC1200A0</td> <td>MOLLA A COMPRESSIO NE DE4 DF0.5 H24</td> <td>4</td> <td>PZ</td> </tr> <tr> <td>VI0239A1</td> <td>VITE AUTOFIL. 4.2X25 TCB+ INOX</td> <td>4</td> <td>PZ</td> </tr> <tr> <td>VI1220A1</td> <td>VITE AUTOFILETTA NTE 4.2X11 TCS+ MARUTE</td> <td>2</td> <td>PZ</td> </tr> <tr> <td>VM1182B0</td> <td>ATTACCO MANIGLIA CON GUIDA PERNO CT BT</td> <td>1</td> <td>PZ</td> </tr> <tr> <td>VM1182B1</td> <td>ATTACCO MANIGLIA CON GUIDA PERNO CT BT</td> <td>1</td> <td>PZ</td> </tr> <tr> <td>VM1183A1</td> <td>PERNO MANIGLIA CHEFTOP BAKERTOP</td> <td>1</td> <td>PZ</td> </tr> </tbody> </table>	Codice	Descrizione	Qtà	UM	0H7321A0	PIASTRINA COPERCHIETT O MANIGLIA M	1	PZ	RC1200A0	MOLLA A COMPRESSIO NE DE4 DF0.5 H24	4	PZ	VI0239A1	VITE AUTOFIL. 4.2X25 TCB+ INOX	4	PZ	VI1220A1	VITE AUTOFILETTA NTE 4.2X11 TCS+ MARUTE	2	PZ	VM1182B0	ATTACCO MANIGLIA CON GUIDA PERNO CT BT	1	PZ	VM1182B1	ATTACCO MANIGLIA CON GUIDA PERNO CT BT	1	PZ	VM1183A1	PERNO MANIGLIA CHEFTOP BAKERTOP	1	PZ
Codice	Descrizione	Qtà	UM																																		
0H7321A0	PIASTRINA COPERCHIETT O MANIGLIA M	1	PZ																																		
RC1200A0	MOLLA A COMPRESSIO NE DE4 DF0.5 H24	4	PZ																																		
VI0239A1	VITE AUTOFIL. 4.2X25 TCB+ INOX	4	PZ																																		
VI1220A1	VITE AUTOFILETTA NTE 4.2X11 TCS+ MARUTE	2	PZ																																		
VM1182B0	ATTACCO MANIGLIA CON GUIDA PERNO CT BT	1	PZ																																		
VM1182B1	ATTACCO MANIGLIA CON GUIDA PERNO CT BT	1	PZ																																		
VM1183A1	PERNO MANIGLIA CHEFTOP BAKERTOP	1	PZ																																		

COMPONENTE			RICAMBIO																																						
Codice	Descrizione	Immagine	Codice	Descrizione	Lista componenti																																				
MG1083A	ASSIEME MANIGLIA COMPLETO MM		KMG1083A	KIT MANIGLIA COMPLETA MM	<table border="1"> <thead> <tr> <th>Codice</th> <th>Descrizione</th> <th>Qtà</th> <th>UM</th> </tr> </thead> <tbody> <tr> <td>VM1183B0</td> <td>PERNO MANIGLIA CT BT</td> <td>1</td> <td>PZ</td> </tr> <tr> <td>VM1490A0</td> <td>COPRI VITI MANIGLIA CHEFTOP BAKERTOP</td> <td>2</td> <td>PZ</td> </tr> <tr> <td>VM1695A0</td> <td>PERNO POSIZIONE MANIGLIA</td> <td>4</td> <td>PZ</td> </tr> <tr> <td>VM2245A0</td> <td>IMPUGNATUR A MANIGLIA CON SCROCC</td> <td>1</td> <td>PZ</td> </tr> <tr> <td>VM2247A0</td> <td>COVER IMPUGNATUR A MANIGLIA VM2245-2246</td> <td>1</td> <td>PZ</td> </tr> <tr> <td>VM2248A0</td> <td>CHIAVETTA CHIUSURA MANIGLIA CON SCROCC</td> <td>1</td> <td>PZ</td> </tr> <tr> <td>VM2248B0</td> <td>CHIAVETTA CHIUSURA MANIGLIA CON SCROCC</td> <td>1</td> <td>PZ</td> </tr> <tr> <td>VM2295A0</td> <td>PENNINO PER CONTROLLO MM</td> <td>1</td> <td>PZ</td> </tr> </tbody> </table>	Codice	Descrizione	Qtà	UM	VM1183B0	PERNO MANIGLIA CT BT	1	PZ	VM1490A0	COPRI VITI MANIGLIA CHEFTOP BAKERTOP	2	PZ	VM1695A0	PERNO POSIZIONE MANIGLIA	4	PZ	VM2245A0	IMPUGNATUR A MANIGLIA CON SCROCC	1	PZ	VM2247A0	COVER IMPUGNATUR A MANIGLIA VM2245-2246	1	PZ	VM2248A0	CHIAVETTA CHIUSURA MANIGLIA CON SCROCC	1	PZ	VM2248B0	CHIAVETTA CHIUSURA MANIGLIA CON SCROCC	1	PZ	VM2295A0	PENNINO PER CONTROLLO MM	1	PZ
					Codice	Descrizione	Qtà	UM																																	
					VM1183B0	PERNO MANIGLIA CT BT	1	PZ																																	
					VM1490A0	COPRI VITI MANIGLIA CHEFTOP BAKERTOP	2	PZ																																	
					VM1695A0	PERNO POSIZIONE MANIGLIA	4	PZ																																	
					VM2245A0	IMPUGNATUR A MANIGLIA CON SCROCC	1	PZ																																	
					VM2247A0	COVER IMPUGNATUR A MANIGLIA VM2245-2246	1	PZ																																	
					VM2248A0	CHIAVETTA CHIUSURA MANIGLIA CON SCROCC	1	PZ																																	
					VM2248B0	CHIAVETTA CHIUSURA MANIGLIA CON SCROCC	1	PZ																																	
					VM2295A0	PENNINO PER CONTROLLO MM	1	PZ																																	
VM2274A	BOCCOLA SCANALATA		KVM2274A	KIT BOCCOLA SCANALATA VM2274A0	<table border="1"> <thead> <tr> <th>Codice</th> <th>Descrizione</th> <th>Qtà</th> <th>UM</th> </tr> </thead> <tbody> <tr> <td>VM2274A0</td> <td>BOCCOLA SCANALATA</td> <td>1</td> <td>PZ</td> </tr> </tbody> </table>	Codice	Descrizione	Qtà	UM	VM2274A0	BOCCOLA SCANALATA	1	PZ																												
					Codice	Descrizione	Qtà	UM																																	
					VM2274A0	BOCCOLA SCANALATA	1	PZ																																	
					K0B1126AR	KIT TRAVERSO INF. PORTA BAKERTOP DX	<table border="1"> <thead> <tr> <th>Codice</th> <th>Descrizione</th> <th>Qtà</th> <th>UM</th> </tr> </thead> <tbody> <tr> <td>0B1126A0</td> <td>TRAVERSO INFERIORE PORTA 860 M</td> <td>1</td> <td>PZ</td> </tr> <tr> <td>RC1200A0</td> <td>MOLLA A COMPRESSIO NE DE4 DF0.5 H24</td> <td>2</td> <td>PZ</td> </tr> <tr> <td>V11220A1</td> <td>VITE AUTOFILETTA NTE 4.2X11 TCS+ MARUTE</td> <td>1</td> <td>PZ</td> </tr> <tr> <td>V11996A0</td> <td>VITE M5X35 TCEI ZN</td> <td>7</td> <td>PZ</td> </tr> <tr> <td>VM1794A0</td> <td>FASCETTA 250X4.8 PA66 NERA</td> <td>2</td> <td>PZ</td> </tr> <tr> <td>VM2103A0</td> <td>PIASTRINA FERMAFASCE TTA</td> <td>2</td> <td>PZ</td> </tr> <tr> <td>VM2259A1</td> <td>TAPPO INF SX PORTA S6</td> <td>1</td> <td>PZ</td> </tr> </tbody> </table>	Codice	Descrizione	Qtà	UM	0B1126A0	TRAVERSO INFERIORE PORTA 860 M	1	PZ	RC1200A0	MOLLA A COMPRESSIO NE DE4 DF0.5 H24	2	PZ	V11220A1	VITE AUTOFILETTA NTE 4.2X11 TCS+ MARUTE	1	PZ	V11996A0	VITE M5X35 TCEI ZN	7	PZ	VM1794A0	FASCETTA 250X4.8 PA66 NERA	2	PZ	VM2103A0	PIASTRINA FERMAFASCE TTA	2	PZ	VM2259A1	TAPPO INF SX PORTA S6	1	PZ		
							Codice	Descrizione	Qtà	UM																															
							0B1126A0	TRAVERSO INFERIORE PORTA 860 M	1	PZ																															
							RC1200A0	MOLLA A COMPRESSIO NE DE4 DF0.5 H24	2	PZ																															
							V11220A1	VITE AUTOFILETTA NTE 4.2X11 TCS+ MARUTE	1	PZ																															
							V11996A0	VITE M5X35 TCEI ZN	7	PZ																															
							VM1794A0	FASCETTA 250X4.8 PA66 NERA	2	PZ																															
VM2103A0	PIASTRINA FERMAFASCE TTA	2	PZ																																						
VM2259A1	TAPPO INF SX PORTA S6	1	PZ																																						

COMPONENTE			RICAMBIO																																																			
Codice	Descrizione	Immagine	Codice	Descrizione	Lista componenti																																																	
VM2274A	BOCCOLA SCANALATA		K0B1126AR	KIT TRAVERSO INF. PORTA BAKERTOP DX	<table border="1"> <thead> <tr> <th>Codice</th> <th>Descrizione</th> <th>Qtà</th> <th>UM</th> </tr> </thead> <tbody> <tr> <td>VM2261A1</td> <td>TAPPO INF DX PORTA S6</td> <td>1</td> <td>PZ</td> </tr> <tr> <td>VM2267A0</td> <td>CORSOIO SISTEMA FERMA VETRO INT</td> <td>1</td> <td>PZ</td> </tr> <tr> <td>VM2269A0</td> <td>TAPPO SISTEMA FERMA VETRO INT</td> <td>1</td> <td>PZ</td> </tr> <tr> <td>VM2274A0</td> <td>BOCCOLA SCANALATA</td> <td>1</td> <td>PZ</td> </tr> <tr> <td>VM2305A0</td> <td>NOTTOLINO FISSAGGIO TAPPI PORTE MM</td> <td>7</td> <td>PZ</td> </tr> </tbody> </table>	Codice	Descrizione	Qtà	UM	VM2261A1	TAPPO INF DX PORTA S6	1	PZ	VM2267A0	CORSOIO SISTEMA FERMA VETRO INT	1	PZ	VM2269A0	TAPPO SISTEMA FERMA VETRO INT	1	PZ	VM2274A0	BOCCOLA SCANALATA	1	PZ	VM2305A0	NOTTOLINO FISSAGGIO TAPPI PORTE MM	7	PZ																									
			Codice	Descrizione	Qtà	UM																																																
VM2261A1	TAPPO INF DX PORTA S6	1	PZ																																																			
VM2267A0	CORSOIO SISTEMA FERMA VETRO INT	1	PZ																																																			
VM2269A0	TAPPO SISTEMA FERMA VETRO INT	1	PZ																																																			
VM2274A0	BOCCOLA SCANALATA	1	PZ																																																			
VM2305A0	NOTTOLINO FISSAGGIO TAPPI PORTE MM	7	PZ																																																			
K0B1126AL	KIT TRAVERSO INF PORTA BAKERTOP SX	<table border="1"> <thead> <tr> <th>Codice</th> <th>Descrizione</th> <th>Qtà</th> <th>UM</th> </tr> </thead> <tbody> <tr> <td>0B1126A0</td> <td>TRAVERSO INFERIORE PORTA 860 M</td> <td>1</td> <td>PZ</td> </tr> <tr> <td>RC1200A0</td> <td>MOLLA A COMPRESSIO NE DE4 DF0.5 H24</td> <td>2</td> <td>PZ</td> </tr> <tr> <td>VI1220A1</td> <td>VITE AUTOFILETTA NTE 4.2X11 TCS+ MARUTE</td> <td>1</td> <td>PZ</td> </tr> <tr> <td>VI1996A0</td> <td>VITE M5X35 TCEI ZN</td> <td>7</td> <td>PZ</td> </tr> <tr> <td>VM1794A0</td> <td>FASCETTA 250X4.8 PA66 NERA</td> <td>2</td> <td>PZ</td> </tr> <tr> <td>VM2103A0</td> <td>PIASTRINA FERMAFASCE TTA</td> <td>2</td> <td>PZ</td> </tr> <tr> <td>VM2267A0</td> <td>CORSOIO SISTEMA FERMA VETRO INT</td> <td>1</td> <td>PZ</td> </tr> <tr> <td>VM2269A0</td> <td>TAPPO SISTEMA FERMA VETRO INT</td> <td>1</td> <td>PZ</td> </tr> <tr> <td>VM2274A0</td> <td>BOCCOLA SCANALATA</td> <td>1</td> <td>PZ</td> </tr> <tr> <td>VM2305A0</td> <td>NOTTOLINO FISSAGGIO TAPPI PORTE MM</td> <td>7</td> <td>PZ</td> </tr> <tr> <td>VM2384A0</td> <td>TAPPO INF DX PORTA MM LEFT</td> <td>1</td> <td>PZ</td> </tr> <tr> <td>VM2386A1</td> <td>TAPPO INF SX PORTA MM LEFT</td> <td>1</td> <td>PZ</td> </tr> </tbody> </table>	Codice	Descrizione	Qtà	UM	0B1126A0	TRAVERSO INFERIORE PORTA 860 M	1	PZ	RC1200A0	MOLLA A COMPRESSIO NE DE4 DF0.5 H24	2	PZ	VI1220A1	VITE AUTOFILETTA NTE 4.2X11 TCS+ MARUTE	1	PZ	VI1996A0	VITE M5X35 TCEI ZN	7	PZ	VM1794A0	FASCETTA 250X4.8 PA66 NERA	2	PZ	VM2103A0	PIASTRINA FERMAFASCE TTA	2	PZ	VM2267A0	CORSOIO SISTEMA FERMA VETRO INT	1	PZ	VM2269A0	TAPPO SISTEMA FERMA VETRO INT	1	PZ	VM2274A0	BOCCOLA SCANALATA	1	PZ	VM2305A0	NOTTOLINO FISSAGGIO TAPPI PORTE MM	7	PZ	VM2384A0	TAPPO INF DX PORTA MM LEFT	1	PZ	VM2386A1	TAPPO INF SX PORTA MM LEFT	1	PZ
Codice	Descrizione	Qtà	UM																																																			
0B1126A0	TRAVERSO INFERIORE PORTA 860 M	1	PZ																																																			
RC1200A0	MOLLA A COMPRESSIO NE DE4 DF0.5 H24	2	PZ																																																			
VI1220A1	VITE AUTOFILETTA NTE 4.2X11 TCS+ MARUTE	1	PZ																																																			
VI1996A0	VITE M5X35 TCEI ZN	7	PZ																																																			
VM1794A0	FASCETTA 250X4.8 PA66 NERA	2	PZ																																																			
VM2103A0	PIASTRINA FERMAFASCE TTA	2	PZ																																																			
VM2267A0	CORSOIO SISTEMA FERMA VETRO INT	1	PZ																																																			
VM2269A0	TAPPO SISTEMA FERMA VETRO INT	1	PZ																																																			
VM2274A0	BOCCOLA SCANALATA	1	PZ																																																			
VM2305A0	NOTTOLINO FISSAGGIO TAPPI PORTE MM	7	PZ																																																			
VM2384A0	TAPPO INF DX PORTA MM LEFT	1	PZ																																																			
VM2386A1	TAPPO INF SX PORTA MM LEFT	1	PZ																																																			

COMPONENTE			RICAMBIO																																																						
Codice	Descrizione	Immagine	Codice	Descrizione	Lista componenti																																																				
VM2274A	BOCCOLA SCANALATA		K0B1122AR	KIT TRAVERSO INF. PORTA CHEFTOP D	<table border="1"> <thead> <tr> <th>Codice</th> <th>Descrizione</th> <th>Qtà</th> <th>UM</th> </tr> </thead> <tbody> <tr> <td>0B1122A0</td> <td>TRAVERSO INFERIORE PORTA 750 M</td> <td>1</td> <td>PZ</td> </tr> <tr> <td>RC1200A0</td> <td>MOLLA A COMPRESSIO NE DE4 DF0.5 H24</td> <td>2</td> <td>PZ</td> </tr> <tr> <td>VI1220A1</td> <td>VITE AUTOFISETTA NTE 4.2X11 TCS+ MARUTE</td> <td>1</td> <td>PZ</td> </tr> <tr> <td>VI1996A0</td> <td>VITE M5X35 TCEI ZN</td> <td>7</td> <td>PZ</td> </tr> <tr> <td>VM1794A0</td> <td>FASCETTA 250X4.8 PA66 NERA</td> <td>2</td> <td>PZ</td> </tr> <tr> <td>VM2103A0</td> <td>PIASTRINA FERMAFASCE TTA</td> <td>2</td> <td>PZ</td> </tr> <tr> <td>VM2259A1</td> <td>TAPPO INF SX PORTA S6</td> <td>1</td> <td>PZ</td> </tr> <tr> <td>VM2261A1</td> <td>TAPPO INF DX PORTA S6</td> <td>1</td> <td>PZ</td> </tr> <tr> <td>VM2267A0</td> <td>CORSOIO SISTEMA FERMA VETRO INT</td> <td>1</td> <td>PZ</td> </tr> <tr> <td>VM2269A0</td> <td>TAPPO SISTEMA FERMA VETRO INT</td> <td>1</td> <td>PZ</td> </tr> <tr> <td>VM2274A0</td> <td>BOCCOLA SCANALATA</td> <td>1</td> <td>PZ</td> </tr> <tr> <td>VM2305A0</td> <td>NOTTOLINO FISSAGGIO TAPPI PORTE MM</td> <td>7</td> <td>PZ</td> </tr> </tbody> </table>	Codice	Descrizione	Qtà	UM	0B1122A0	TRAVERSO INFERIORE PORTA 750 M	1	PZ	RC1200A0	MOLLA A COMPRESSIO NE DE4 DF0.5 H24	2	PZ	VI1220A1	VITE AUTOFISETTA NTE 4.2X11 TCS+ MARUTE	1	PZ	VI1996A0	VITE M5X35 TCEI ZN	7	PZ	VM1794A0	FASCETTA 250X4.8 PA66 NERA	2	PZ	VM2103A0	PIASTRINA FERMAFASCE TTA	2	PZ	VM2259A1	TAPPO INF SX PORTA S6	1	PZ	VM2261A1	TAPPO INF DX PORTA S6	1	PZ	VM2267A0	CORSOIO SISTEMA FERMA VETRO INT	1	PZ	VM2269A0	TAPPO SISTEMA FERMA VETRO INT	1	PZ	VM2274A0	BOCCOLA SCANALATA	1	PZ	VM2305A0	NOTTOLINO FISSAGGIO TAPPI PORTE MM	7	PZ
			Codice	Descrizione	Qtà	UM																																																			
0B1122A0	TRAVERSO INFERIORE PORTA 750 M	1	PZ																																																						
RC1200A0	MOLLA A COMPRESSIO NE DE4 DF0.5 H24	2	PZ																																																						
VI1220A1	VITE AUTOFISETTA NTE 4.2X11 TCS+ MARUTE	1	PZ																																																						
VI1996A0	VITE M5X35 TCEI ZN	7	PZ																																																						
VM1794A0	FASCETTA 250X4.8 PA66 NERA	2	PZ																																																						
VM2103A0	PIASTRINA FERMAFASCE TTA	2	PZ																																																						
VM2259A1	TAPPO INF SX PORTA S6	1	PZ																																																						
VM2261A1	TAPPO INF DX PORTA S6	1	PZ																																																						
VM2267A0	CORSOIO SISTEMA FERMA VETRO INT	1	PZ																																																						
VM2269A0	TAPPO SISTEMA FERMA VETRO INT	1	PZ																																																						
VM2274A0	BOCCOLA SCANALATA	1	PZ																																																						
VM2305A0	NOTTOLINO FISSAGGIO TAPPI PORTE MM	7	PZ																																																						
K0B1122AL	KIT TRAVERSO INF. PORTA CHEFTOP MM SX	<table border="1"> <thead> <tr> <th>Codice</th> <th>Descrizione</th> <th>Qtà</th> <th>UM</th> </tr> </thead> <tbody> <tr> <td>0B1122A0</td> <td>TRAVERSO INFERIORE PORTA 750 M</td> <td>1</td> <td>PZ</td> </tr> <tr> <td>RC1200A0</td> <td>MOLLA A COMPRESSIO NE DE4 DF0.5 H24</td> <td>2</td> <td>PZ</td> </tr> <tr> <td>VI1220A1</td> <td>VITE AUTOFISETTA NTE 4.2X11 TCS+ MARUTE</td> <td>1</td> <td>PZ</td> </tr> <tr> <td>VI1996A0</td> <td>VITE M5X35 TCEI ZN</td> <td>7</td> <td>PZ</td> </tr> <tr> <td>VM1794A0</td> <td>FASCETTA 250X4.8 PA66 NERA</td> <td>2</td> <td>PZ</td> </tr> </tbody> </table>	Codice	Descrizione	Qtà	UM	0B1122A0	TRAVERSO INFERIORE PORTA 750 M	1	PZ	RC1200A0	MOLLA A COMPRESSIO NE DE4 DF0.5 H24	2	PZ	VI1220A1	VITE AUTOFISETTA NTE 4.2X11 TCS+ MARUTE	1	PZ	VI1996A0	VITE M5X35 TCEI ZN	7	PZ	VM1794A0	FASCETTA 250X4.8 PA66 NERA	2	PZ																															
Codice	Descrizione	Qtà	UM																																																						
0B1122A0	TRAVERSO INFERIORE PORTA 750 M	1	PZ																																																						
RC1200A0	MOLLA A COMPRESSIO NE DE4 DF0.5 H24	2	PZ																																																						
VI1220A1	VITE AUTOFISETTA NTE 4.2X11 TCS+ MARUTE	1	PZ																																																						
VI1996A0	VITE M5X35 TCEI ZN	7	PZ																																																						
VM1794A0	FASCETTA 250X4.8 PA66 NERA	2	PZ																																																						

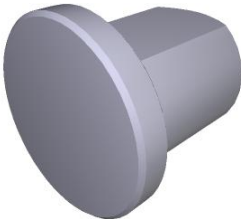
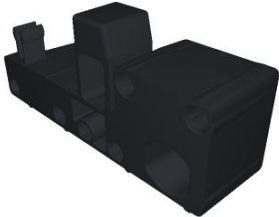
COMPONENTE			RICAMBIO																																		
Codice	Descrizione	Immagine	Codice	Descrizione	Lista componenti																																
VM2274A	BOCCOLA SCANALATA		K0B1122AL	KIT TRAVERSO INF. PORTA CHEFTOP MM SX	<table border="1"> <thead> <tr> <th>Codice</th> <th>Descrizione</th> <th>Qtà</th> <th>UM</th> </tr> </thead> <tbody> <tr> <td>VM2103A0</td> <td>PIASTRINA FERMAFASCE TTA</td> <td>2</td> <td>PZ</td> </tr> <tr> <td>VM2267A0</td> <td>CORSOIO SISTEMA FERMA VETRO INT</td> <td>1</td> <td>PZ</td> </tr> <tr> <td>VM2269A0</td> <td>TAPPO SISTEMA FERMA VETRO INT</td> <td>1</td> <td>PZ</td> </tr> <tr> <td>VM2274A0</td> <td>BOCCOLA SCANALATA</td> <td>1</td> <td>PZ</td> </tr> <tr> <td>VM2305A0</td> <td>NOTTOLINO FISSAGGIO TAPPI PORTE MM</td> <td>7</td> <td>PZ</td> </tr> <tr> <td>VM2384A0</td> <td>TAPPO INF DX PORTA MM LEFT</td> <td>1</td> <td>PZ</td> </tr> <tr> <td>VM2386A1</td> <td>TAPPO INF SX PORTA MM LEFT</td> <td>1</td> <td>PZ</td> </tr> </tbody> </table>	Codice	Descrizione	Qtà	UM	VM2103A0	PIASTRINA FERMAFASCE TTA	2	PZ	VM2267A0	CORSOIO SISTEMA FERMA VETRO INT	1	PZ	VM2269A0	TAPPO SISTEMA FERMA VETRO INT	1	PZ	VM2274A0	BOCCOLA SCANALATA	1	PZ	VM2305A0	NOTTOLINO FISSAGGIO TAPPI PORTE MM	7	PZ	VM2384A0	TAPPO INF DX PORTA MM LEFT	1	PZ	VM2386A1	TAPPO INF SX PORTA MM LEFT	1	PZ
Codice	Descrizione	Qtà	UM																																		
VM2103A0	PIASTRINA FERMAFASCE TTA	2	PZ																																		
VM2267A0	CORSOIO SISTEMA FERMA VETRO INT	1	PZ																																		
VM2269A0	TAPPO SISTEMA FERMA VETRO INT	1	PZ																																		
VM2274A0	BOCCOLA SCANALATA	1	PZ																																		
VM2305A0	NOTTOLINO FISSAGGIO TAPPI PORTE MM	7	PZ																																		
VM2384A0	TAPPO INF DX PORTA MM LEFT	1	PZ																																		
VM2386A1	TAPPO INF SX PORTA MM LEFT	1	PZ																																		
VM2305A	NOTTOLINO FISSAGGIO TAPPI PORTE MM		VM2305A0	NOTTOLINO FISSAGGIO TAPPI PORTE MM																																	
VM2259A	TAPPO INF SX PORTA S6		KVM2259A	KIT TAPPO INFERIORE SX PORTA MM	<table border="1"> <thead> <tr> <th>Codice</th> <th>Descrizione</th> <th>Qtà</th> <th>UM</th> </tr> </thead> <tbody> <tr> <td>VI1996A0</td> <td>VITE M5X35 TCEI ZN</td> <td>3</td> <td>PZ</td> </tr> <tr> <td>VM2259A1</td> <td>TAPPO INF SX PORTA S6</td> <td>1</td> <td>PZ</td> </tr> <tr> <td>VM2305A0</td> <td>NOTTOLINO FISSAGGIO TAPPI PORTE MM</td> <td>3</td> <td>PZ</td> </tr> </tbody> </table>	Codice	Descrizione	Qtà	UM	VI1996A0	VITE M5X35 TCEI ZN	3	PZ	VM2259A1	TAPPO INF SX PORTA S6	1	PZ	VM2305A0	NOTTOLINO FISSAGGIO TAPPI PORTE MM	3	PZ																
Codice	Descrizione	Qtà	UM																																		
VI1996A0	VITE M5X35 TCEI ZN	3	PZ																																		
VM2259A1	TAPPO INF SX PORTA S6	1	PZ																																		
VM2305A0	NOTTOLINO FISSAGGIO TAPPI PORTE MM	3	PZ																																		
			K0B1126AR	KIT TRAVERSO INF. PORTA BAKERTOP DX	<table border="1"> <thead> <tr> <th>Codice</th> <th>Descrizione</th> <th>Qtà</th> <th>UM</th> </tr> </thead> <tbody> <tr> <td>0B1126A0</td> <td>TRAVERSO INFERIORE PORTA 860 M</td> <td>1</td> <td>PZ</td> </tr> <tr> <td>RC1200A0</td> <td>MOLLA A COMPRESSIO NE DE4 DF0.5 H24</td> <td>2</td> <td>PZ</td> </tr> </tbody> </table>	Codice	Descrizione	Qtà	UM	0B1126A0	TRAVERSO INFERIORE PORTA 860 M	1	PZ	RC1200A0	MOLLA A COMPRESSIO NE DE4 DF0.5 H24	2	PZ																				
Codice	Descrizione	Qtà	UM																																		
0B1126A0	TRAVERSO INFERIORE PORTA 860 M	1	PZ																																		
RC1200A0	MOLLA A COMPRESSIO NE DE4 DF0.5 H24	2	PZ																																		

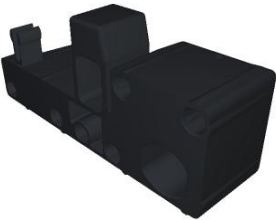
COMPONENTE			RICAMBIO																																														
Codice	Descrizione	Immagine	Codice	Descrizione	Lista componenti																																												
VM2259A	TAPPO INF SX PORTA S6		K0B1126AR	KIT TRAVERSO INF. PORTA BAKERTOP DX	<table border="1"> <thead> <tr> <th>Codice</th> <th>Descrizione</th> <th>Qtà</th> <th>UM</th> </tr> </thead> <tbody> <tr> <td>VI1220A1</td> <td>VITE AUTOFILETTA NTE 4.2X11 TCS+ MARUTE</td> <td>1</td> <td>PZ</td> </tr> <tr> <td>VI1996A0</td> <td>VITE M5X35 TCEI ZN</td> <td>7</td> <td>PZ</td> </tr> <tr> <td>VM1794A0</td> <td>FASCETTA 250X4.8 PA66 NERA</td> <td>2</td> <td>PZ</td> </tr> <tr> <td>VM2103A0</td> <td>PIASTRINA FERMAFASCE TTA</td> <td>2</td> <td>PZ</td> </tr> <tr> <td>VM2259A1</td> <td>TAPPO INF SX PORTA S6</td> <td>1</td> <td>PZ</td> </tr> <tr> <td>VM2261A1</td> <td>TAPPO INF DX PORTA S6</td> <td>1</td> <td>PZ</td> </tr> <tr> <td>VM2267A0</td> <td>CORSOIO SISTEMA FERMA VETRO INT</td> <td>1</td> <td>PZ</td> </tr> <tr> <td>VM2269A0</td> <td>TAPPO SISTEMA FERMA VETRO INT</td> <td>1</td> <td>PZ</td> </tr> <tr> <td>VM2274A0</td> <td>BOCCOLA SCANALATA</td> <td>1</td> <td>PZ</td> </tr> <tr> <td>VM2305A0</td> <td>NOTTOLINO FISSAGGIO TAPPI PORTE MM</td> <td>7</td> <td>PZ</td> </tr> </tbody> </table>	Codice	Descrizione	Qtà	UM	VI1220A1	VITE AUTOFILETTA NTE 4.2X11 TCS+ MARUTE	1	PZ	VI1996A0	VITE M5X35 TCEI ZN	7	PZ	VM1794A0	FASCETTA 250X4.8 PA66 NERA	2	PZ	VM2103A0	PIASTRINA FERMAFASCE TTA	2	PZ	VM2259A1	TAPPO INF SX PORTA S6	1	PZ	VM2261A1	TAPPO INF DX PORTA S6	1	PZ	VM2267A0	CORSOIO SISTEMA FERMA VETRO INT	1	PZ	VM2269A0	TAPPO SISTEMA FERMA VETRO INT	1	PZ	VM2274A0	BOCCOLA SCANALATA	1	PZ	VM2305A0	NOTTOLINO FISSAGGIO TAPPI PORTE MM	7	PZ
			Codice	Descrizione	Qtà	UM																																											
VI1220A1	VITE AUTOFILETTA NTE 4.2X11 TCS+ MARUTE	1	PZ																																														
VI1996A0	VITE M5X35 TCEI ZN	7	PZ																																														
VM1794A0	FASCETTA 250X4.8 PA66 NERA	2	PZ																																														
VM2103A0	PIASTRINA FERMAFASCE TTA	2	PZ																																														
VM2259A1	TAPPO INF SX PORTA S6	1	PZ																																														
VM2261A1	TAPPO INF DX PORTA S6	1	PZ																																														
VM2267A0	CORSOIO SISTEMA FERMA VETRO INT	1	PZ																																														
VM2269A0	TAPPO SISTEMA FERMA VETRO INT	1	PZ																																														
VM2274A0	BOCCOLA SCANALATA	1	PZ																																														
VM2305A0	NOTTOLINO FISSAGGIO TAPPI PORTE MM	7	PZ																																														
K0B1126AL	KIT TRAVERSO INF PORTA BAKERTOP SX	<table border="1"> <thead> <tr> <th>Codice</th> <th>Descrizione</th> <th>Qtà</th> <th>UM</th> </tr> </thead> <tbody> <tr> <td>OB1126A0</td> <td>TRAVERSO INFERIORE PORTA 860 M</td> <td>1</td> <td>PZ</td> </tr> <tr> <td>RC1200A0</td> <td>MOLLA A COMPRESSIO NE DE4 DF0.5 H24</td> <td>2</td> <td>PZ</td> </tr> <tr> <td>VI1220A1</td> <td>VITE AUTOFILETTA NTE 4.2X11 TCS+ MARUTE</td> <td>1</td> <td>PZ</td> </tr> <tr> <td>VI1996A0</td> <td>VITE M5X35 TCEI ZN</td> <td>7</td> <td>PZ</td> </tr> <tr> <td>VM1794A0</td> <td>FASCETTA 250X4.8 PA66 NERA</td> <td>2</td> <td>PZ</td> </tr> <tr> <td>VM2103A0</td> <td>PIASTRINA FERMAFASCE TTA</td> <td>2</td> <td>PZ</td> </tr> <tr> <td>VM2267A0</td> <td>CORSOIO SISTEMA FERMA VETRO INT</td> <td>1</td> <td>PZ</td> </tr> </tbody> </table>	Codice	Descrizione	Qtà	UM	OB1126A0	TRAVERSO INFERIORE PORTA 860 M	1	PZ	RC1200A0	MOLLA A COMPRESSIO NE DE4 DF0.5 H24	2	PZ	VI1220A1	VITE AUTOFILETTA NTE 4.2X11 TCS+ MARUTE	1	PZ	VI1996A0	VITE M5X35 TCEI ZN	7	PZ	VM1794A0	FASCETTA 250X4.8 PA66 NERA	2	PZ	VM2103A0	PIASTRINA FERMAFASCE TTA	2	PZ	VM2267A0	CORSOIO SISTEMA FERMA VETRO INT	1	PZ															
Codice	Descrizione	Qtà	UM																																														
OB1126A0	TRAVERSO INFERIORE PORTA 860 M	1	PZ																																														
RC1200A0	MOLLA A COMPRESSIO NE DE4 DF0.5 H24	2	PZ																																														
VI1220A1	VITE AUTOFILETTA NTE 4.2X11 TCS+ MARUTE	1	PZ																																														
VI1996A0	VITE M5X35 TCEI ZN	7	PZ																																														
VM1794A0	FASCETTA 250X4.8 PA66 NERA	2	PZ																																														
VM2103A0	PIASTRINA FERMAFASCE TTA	2	PZ																																														
VM2267A0	CORSOIO SISTEMA FERMA VETRO INT	1	PZ																																														



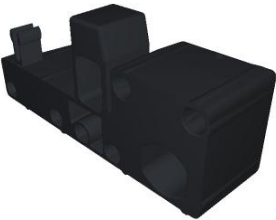

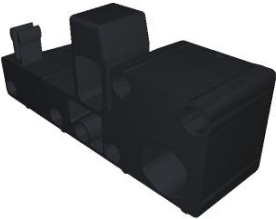
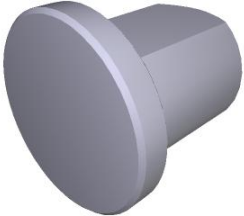
COMPONENTE			RICAMBIO																																																			
Codice	Descrizione	Immagine	Codice	Descrizione	Lista componenti																																																	
VM2259A	TAPPO INF SX PORTA S6		K0B1126AL	KIT TRAVERSO INF PORTA BAKERTOP SX	<table border="1"> <thead> <tr> <th>Codice</th> <th>Descrizione</th> <th>Qtà</th> <th>UM</th> </tr> </thead> <tbody> <tr> <td>VM2269A0</td> <td>TAPPO SISTEMA FERMA VETRO INT</td> <td>1</td> <td>PZ</td> </tr> <tr> <td>VM2274A0</td> <td>BOCCOLA SCANALATA</td> <td>1</td> <td>PZ</td> </tr> <tr> <td>VM2305A0</td> <td>NOTTOLINO FISSAGGIO TAPPI PORTE MM</td> <td>7</td> <td>PZ</td> </tr> <tr> <td>VM2384A0</td> <td>TAPPO INF DX PORTA MM LEFT</td> <td>1</td> <td>PZ</td> </tr> <tr> <td>VM2386A1</td> <td>TAPPO INF SX PORTA MM LEFT</td> <td>1</td> <td>PZ</td> </tr> </tbody> </table>	Codice	Descrizione	Qtà	UM	VM2269A0	TAPPO SISTEMA FERMA VETRO INT	1	PZ	VM2274A0	BOCCOLA SCANALATA	1	PZ	VM2305A0	NOTTOLINO FISSAGGIO TAPPI PORTE MM	7	PZ	VM2384A0	TAPPO INF DX PORTA MM LEFT	1	PZ	VM2386A1	TAPPO INF SX PORTA MM LEFT	1	PZ																									
			Codice	Descrizione	Qtà	UM																																																
VM2269A0	TAPPO SISTEMA FERMA VETRO INT	1	PZ																																																			
VM2274A0	BOCCOLA SCANALATA	1	PZ																																																			
VM2305A0	NOTTOLINO FISSAGGIO TAPPI PORTE MM	7	PZ																																																			
VM2384A0	TAPPO INF DX PORTA MM LEFT	1	PZ																																																			
VM2386A1	TAPPO INF SX PORTA MM LEFT	1	PZ																																																			
K0B1122AR	KIT TRAVERSO INF. PORTA CHEFTOP D	<table border="1"> <thead> <tr> <th>Codice</th> <th>Descrizione</th> <th>Qtà</th> <th>UM</th> </tr> </thead> <tbody> <tr> <td>0B1122A0</td> <td>TRAVERSO INFERIORE PORTA 750 M</td> <td>1</td> <td>PZ</td> </tr> <tr> <td>RC1200A0</td> <td>MOLLA A COMPRESSIO NE DE4 DF0.5 H24</td> <td>2</td> <td>PZ</td> </tr> <tr> <td>VI1220A1</td> <td>VITE AUTOFILETTA NTE 4.2X11 TCS+ MARUTE</td> <td>1</td> <td>PZ</td> </tr> <tr> <td>VI1996A0</td> <td>VITE M5X35 TCEI ZN</td> <td>7</td> <td>PZ</td> </tr> <tr> <td>VM1794A0</td> <td>FASCETTA 250X4.8 PA66 NERA</td> <td>2</td> <td>PZ</td> </tr> <tr> <td>VM2103A0</td> <td>PIASTRINA FERMAFASCE TTA</td> <td>2</td> <td>PZ</td> </tr> <tr> <td>VM2259A1</td> <td>TAPPO INF SX PORTA S6</td> <td>1</td> <td>PZ</td> </tr> <tr> <td>VM2261A1</td> <td>TAPPO INF DX PORTA S6</td> <td>1</td> <td>PZ</td> </tr> <tr> <td>VM2267A0</td> <td>CORSOIO SISTEMA FERMA VETRO INT</td> <td>1</td> <td>PZ</td> </tr> <tr> <td>VM2269A0</td> <td>TAPPO SISTEMA FERMA VETRO INT</td> <td>1</td> <td>PZ</td> </tr> <tr> <td>VM2274A0</td> <td>BOCCOLA SCANALATA</td> <td>1</td> <td>PZ</td> </tr> <tr> <td>VM2305A0</td> <td>NOTTOLINO FISSAGGIO TAPPI PORTE MM</td> <td>7</td> <td>PZ</td> </tr> </tbody> </table>	Codice	Descrizione	Qtà	UM	0B1122A0	TRAVERSO INFERIORE PORTA 750 M	1	PZ	RC1200A0	MOLLA A COMPRESSIO NE DE4 DF0.5 H24	2	PZ	VI1220A1	VITE AUTOFILETTA NTE 4.2X11 TCS+ MARUTE	1	PZ	VI1996A0	VITE M5X35 TCEI ZN	7	PZ	VM1794A0	FASCETTA 250X4.8 PA66 NERA	2	PZ	VM2103A0	PIASTRINA FERMAFASCE TTA	2	PZ	VM2259A1	TAPPO INF SX PORTA S6	1	PZ	VM2261A1	TAPPO INF DX PORTA S6	1	PZ	VM2267A0	CORSOIO SISTEMA FERMA VETRO INT	1	PZ	VM2269A0	TAPPO SISTEMA FERMA VETRO INT	1	PZ	VM2274A0	BOCCOLA SCANALATA	1	PZ	VM2305A0	NOTTOLINO FISSAGGIO TAPPI PORTE MM	7	PZ
Codice	Descrizione	Qtà	UM																																																			
0B1122A0	TRAVERSO INFERIORE PORTA 750 M	1	PZ																																																			
RC1200A0	MOLLA A COMPRESSIO NE DE4 DF0.5 H24	2	PZ																																																			
VI1220A1	VITE AUTOFILETTA NTE 4.2X11 TCS+ MARUTE	1	PZ																																																			
VI1996A0	VITE M5X35 TCEI ZN	7	PZ																																																			
VM1794A0	FASCETTA 250X4.8 PA66 NERA	2	PZ																																																			
VM2103A0	PIASTRINA FERMAFASCE TTA	2	PZ																																																			
VM2259A1	TAPPO INF SX PORTA S6	1	PZ																																																			
VM2261A1	TAPPO INF DX PORTA S6	1	PZ																																																			
VM2267A0	CORSOIO SISTEMA FERMA VETRO INT	1	PZ																																																			
VM2269A0	TAPPO SISTEMA FERMA VETRO INT	1	PZ																																																			
VM2274A0	BOCCOLA SCANALATA	1	PZ																																																			
VM2305A0	NOTTOLINO FISSAGGIO TAPPI PORTE MM	7	PZ																																																			

COMPONENTE			RICAMBIO																																																						
Codice	Descrizione	Immagine	Codice	Descrizione	Lista componenti																																																				
VM2259A	TAPPO INF SX PORTA S6		K0B1122AL	KIT TRAVERSO INF. PORTA CHEFTOP MM SX	<table border="1"> <thead> <tr> <th>Codice</th> <th>Descrizione</th> <th>Qtà</th> <th>UM</th> </tr> </thead> <tbody> <tr> <td>0B1122A0</td> <td>TRAVERSO INFERIORE PORTA 750 M</td> <td>1</td> <td>PZ</td> </tr> <tr> <td>RC1200A0</td> <td>MOLLA A COMPRESSIO NE DE4 DF0.5 H24</td> <td>2</td> <td>PZ</td> </tr> <tr> <td>V11220A1</td> <td>VITE AUTOFILETTA NTE 4.2X11 TCS+ MARUTE</td> <td>1</td> <td>PZ</td> </tr> <tr> <td>VI1996A0</td> <td>VITE M5X35 TCEI ZN</td> <td>7</td> <td>PZ</td> </tr> <tr> <td>VM1794A0</td> <td>FASCETTA 250X4.8 PA66 NERA</td> <td>2</td> <td>PZ</td> </tr> <tr> <td>VM2103A0</td> <td>PIASTRINA FERMAFASCE TTA</td> <td>2</td> <td>PZ</td> </tr> <tr> <td>VM2267A0</td> <td>CORSOIO SISTEMA FERMA VETRO INT</td> <td>1</td> <td>PZ</td> </tr> <tr> <td>VM2269A0</td> <td>TAPPO SISTEMA FERMA VETRO INT</td> <td>1</td> <td>PZ</td> </tr> <tr> <td>VM2274A0</td> <td>BOCCOLA SCANALATA</td> <td>1</td> <td>PZ</td> </tr> <tr> <td>VM2305A0</td> <td>NOTTOLINO FISSAGGIO TAPPI PORTE MM</td> <td>7</td> <td>PZ</td> </tr> <tr> <td>VM2384A0</td> <td>TAPPO INF DX PORTA MM LEFT</td> <td>1</td> <td>PZ</td> </tr> <tr> <td>VM2386A1</td> <td>TAPPO INF SX PORTA MM LEFT</td> <td>1</td> <td>PZ</td> </tr> </tbody> </table>	Codice	Descrizione	Qtà	UM	0B1122A0	TRAVERSO INFERIORE PORTA 750 M	1	PZ	RC1200A0	MOLLA A COMPRESSIO NE DE4 DF0.5 H24	2	PZ	V11220A1	VITE AUTOFILETTA NTE 4.2X11 TCS+ MARUTE	1	PZ	VI1996A0	VITE M5X35 TCEI ZN	7	PZ	VM1794A0	FASCETTA 250X4.8 PA66 NERA	2	PZ	VM2103A0	PIASTRINA FERMAFASCE TTA	2	PZ	VM2267A0	CORSOIO SISTEMA FERMA VETRO INT	1	PZ	VM2269A0	TAPPO SISTEMA FERMA VETRO INT	1	PZ	VM2274A0	BOCCOLA SCANALATA	1	PZ	VM2305A0	NOTTOLINO FISSAGGIO TAPPI PORTE MM	7	PZ	VM2384A0	TAPPO INF DX PORTA MM LEFT	1	PZ	VM2386A1	TAPPO INF SX PORTA MM LEFT	1	PZ
Codice	Descrizione	Qtà	UM																																																						
0B1122A0	TRAVERSO INFERIORE PORTA 750 M	1	PZ																																																						
RC1200A0	MOLLA A COMPRESSIO NE DE4 DF0.5 H24	2	PZ																																																						
V11220A1	VITE AUTOFILETTA NTE 4.2X11 TCS+ MARUTE	1	PZ																																																						
VI1996A0	VITE M5X35 TCEI ZN	7	PZ																																																						
VM1794A0	FASCETTA 250X4.8 PA66 NERA	2	PZ																																																						
VM2103A0	PIASTRINA FERMAFASCE TTA	2	PZ																																																						
VM2267A0	CORSOIO SISTEMA FERMA VETRO INT	1	PZ																																																						
VM2269A0	TAPPO SISTEMA FERMA VETRO INT	1	PZ																																																						
VM2274A0	BOCCOLA SCANALATA	1	PZ																																																						
VM2305A0	NOTTOLINO FISSAGGIO TAPPI PORTE MM	7	PZ																																																						
VM2384A0	TAPPO INF DX PORTA MM LEFT	1	PZ																																																						
VM2386A1	TAPPO INF SX PORTA MM LEFT	1	PZ																																																						
VM2305A	NOTTOLINO FISSAGGIO TAPPI PORTE MM		VM2305A0	NOTTOLINO FISSAGGIO TAPPI PORTE MM																																																					

COMPONENTE			RICAMBIO														
Codice	Descrizione	Immagine	Codice	Descrizione	Lista componenti												
VM2267A	CORSOIO SISTEMA FERMA VETRO INT		VM2267A0	CORSOIO SISTEMA FERMA VETRO INT													
VM2269A	TAPPO SISTEMA FERMA VETRO INT		KVM2269A	KIT TAPPO SISTEMA FERMA VETRO INTERNO	<table border="1"> <thead> <tr> <th>Codice</th> <th>Descrizione</th> <th>Qtà</th> <th>UM</th> </tr> </thead> <tbody> <tr> <td>VM2269A0</td> <td>TAPPO SISTEMA FERMA VETRO INT</td> <td>2</td> <td>PZ</td> </tr> </tbody> </table>	Codice	Descrizione	Qtà	UM	VM2269A0	TAPPO SISTEMA FERMA VETRO INT	2	PZ				
Codice	Descrizione	Qtà	UM														
VM2269A0	TAPPO SISTEMA FERMA VETRO INT	2	PZ														
VE1030A	CALAMITA D=22,9MM PER MICROPORTA		KVE1030A	KIT MAGNETE MICROPORTA 2 PZ	<table border="1"> <thead> <tr> <th>Codice</th> <th>Descrizione</th> <th>Qtà</th> <th>UM</th> </tr> </thead> <tbody> <tr> <td>VE1030A1</td> <td>CALAMITA D=22,9MM PER MICROPORTA</td> <td>2</td> <td>PZ</td> </tr> </tbody> </table>	Codice	Descrizione	Qtà	UM	VE1030A1	CALAMITA D=22,9MM PER MICROPORTA	2	PZ				
Codice	Descrizione	Qtà	UM														
VE1030A1	CALAMITA D=22,9MM PER MICROPORTA	2	PZ														
			KVE1020A	KIT MICROPORTA	<table border="1"> <thead> <tr> <th>Codice</th> <th>Descrizione</th> <th>Qtà</th> <th>UM</th> </tr> </thead> <tbody> <tr> <td>VE1020A2</td> <td>MICROINTERR UTTORE PORTA MAGNETICO</td> <td>1</td> <td>PZ</td> </tr> <tr> <td>VE1030A1</td> <td>CALAMITA D=22,9MM PER MICROPORTA</td> <td>4</td> <td>PZ</td> </tr> </tbody> </table>	Codice	Descrizione	Qtà	UM	VE1020A2	MICROINTERR UTTORE PORTA MAGNETICO	1	PZ	VE1030A1	CALAMITA D=22,9MM PER MICROPORTA	4	PZ
Codice	Descrizione	Qtà	UM														
VE1020A2	MICROINTERR UTTORE PORTA MAGNETICO	1	PZ														
VE1030A1	CALAMITA D=22,9MM PER MICROPORTA	4	PZ														
VM2268A	TAPPO COPRI CALAMITA PORTA		KVM2268A	KIT TAPPO COPRI CALAMITA PORTA	<table border="1"> <thead> <tr> <th>Codice</th> <th>Descrizione</th> <th>Qtà</th> <th>UM</th> </tr> </thead> <tbody> <tr> <td>VM2268A0</td> <td>TAPPO COPRI CALAMITA PORTA</td> <td>1</td> <td>PZ</td> </tr> </tbody> </table>	Codice	Descrizione	Qtà	UM	VM2268A0	TAPPO COPRI CALAMITA PORTA	1	PZ				
Codice	Descrizione	Qtà	UM														
VM2268A0	TAPPO COPRI CALAMITA PORTA	1	PZ														

COMPONENTE			RICAMBIO										
Codice	Descrizione	Immagine	Codice	Descrizione	Lista componenti								
VM2262A	TAPPO SUP DX PORTA S6		KVM2262A	KIT TAPPO SUP. DX PORTA MIND MAPS	<table border="1"> <thead> <tr> <th>Codice</th> <th>Descrizione</th> <th>Qtà</th> <th>UM</th> </tr> </thead> <tbody> <tr> <td>VM2262A1</td> <td>TAPPO SUP DX PORTA S6</td> <td>1</td> <td>PZ</td> </tr> </tbody> </table>	Codice	Descrizione	Qtà	UM	VM2262A1	TAPPO SUP DX PORTA S6	1	PZ
Codice	Descrizione	Qtà	UM										
VM2262A1	TAPPO SUP DX PORTA S6	1	PZ										
VM2305A	NOTTOLINO FISSAGGIO TAPPI PORTE MM		VM2305A0	NOTTOLINO FISSAGGIO TAPPI PORTE MM									
VM2267A	CORSOIO SISTEMA FERMA VETRO INT		VM2267A0	CORSOIO SISTEMA FERMA VETRO INT									
VM2269A	TAPPO SISTEMA FERMA VETRO INT		KVM2269A	KIT TAPPO SISTEMA FERMA VETRO INTERNO	<table border="1"> <thead> <tr> <th>Codice</th> <th>Descrizione</th> <th>Qtà</th> <th>UM</th> </tr> </thead> <tbody> <tr> <td>VM2269A0</td> <td>TAPPO SISTEMA FERMA VETRO INT</td> <td>2</td> <td>PZ</td> </tr> </tbody> </table>	Codice	Descrizione	Qtà	UM	VM2269A0	TAPPO SISTEMA FERMA VETRO INT	2	PZ
Codice	Descrizione	Qtà	UM										
VM2269A0	TAPPO SISTEMA FERMA VETRO INT	2	PZ										
VE1030A	CALAMITA D=22,9MM PER MICROPORTA		KVE1030A	KIT MAGNETE MICROPORTA 2 PZ	<table border="1"> <thead> <tr> <th>Codice</th> <th>Descrizione</th> <th>Qtà</th> <th>UM</th> </tr> </thead> <tbody> <tr> <td>VE1030A1</td> <td>CALAMITA D=22,9MM PER MICROPORTA</td> <td>2</td> <td>PZ</td> </tr> </tbody> </table>	Codice	Descrizione	Qtà	UM	VE1030A1	CALAMITA D=22,9MM PER MICROPORTA	2	PZ
Codice	Descrizione	Qtà	UM										
VE1030A1	CALAMITA D=22,9MM PER MICROPORTA	2	PZ										
			KVE1020A	KIT MICROPORTA	<table border="1"> <thead> <tr> <th>Codice</th> <th>Descrizione</th> <th>Qtà</th> <th>UM</th> </tr> </thead> <tbody> <tr> <td>VE1020A2</td> <td>MICROINTERR UTTORE PORTA MAGNETICO</td> <td>1</td> <td>PZ</td> </tr> </tbody> </table>	Codice	Descrizione	Qtà	UM	VE1020A2	MICROINTERR UTTORE PORTA MAGNETICO	1	PZ
Codice	Descrizione	Qtà	UM										
VE1020A2	MICROINTERR UTTORE PORTA MAGNETICO	1	PZ										
					<table border="1"> <thead> <tr> <th>Codice</th> <th>Descrizione</th> <th>Qtà</th> <th>UM</th> </tr> </thead> <tbody> <tr> <td>VE1030A1</td> <td>CALAMITA D=22,9MM PER MICROPORTA</td> <td>4</td> <td>PZ</td> </tr> </tbody> </table>	Codice	Descrizione	Qtà	UM	VE1030A1	CALAMITA D=22,9MM PER MICROPORTA	4	PZ
Codice	Descrizione	Qtà	UM										
VE1030A1	CALAMITA D=22,9MM PER MICROPORTA	4	PZ										

COMPONENTE			RICAMBIO																																																																						
Codice	Descrizione	Immagine	Codice	Descrizione	Lista componenti																																																																				
VM2268A	TAPPO COPRI CALAMITA PORTA		KVM2268A	KIT TAPPO COPRI CALAMITA PORTA	<table border="1"> <thead> <tr> <th>Codice</th> <th>Descrizione</th> <th>Qtà</th> <th>UM</th> </tr> </thead> <tbody> <tr> <td>VM2268A0</td> <td>TAPPO COPRI CALAMITA PORTA</td> <td>1</td> <td>PZ</td> </tr> </tbody> </table>	Codice	Descrizione	Qtà	UM	VM2268A0	TAPPO COPRI CALAMITA PORTA	1	PZ																																																												
Codice	Descrizione	Qtà	UM																																																																						
VM2268A0	TAPPO COPRI CALAMITA PORTA	1	PZ																																																																						
VM2261A	TAPPO INF DX PORTA S6		<p>KVM2261A</p> <p>K0B1126AR</p>	<p>KIT TAPPO INF. DX PORTA MIND.MAPS</p> <p>KIT TRAVERSO INF. PORTA BAKERTOP DX</p>	<table border="1"> <thead> <tr> <th>Codice</th> <th>Descrizione</th> <th>Qtà</th> <th>UM</th> </tr> </thead> <tbody> <tr> <td>VI1996A0</td> <td>VITE M5X35 TCEI ZN</td> <td>3</td> <td>PZ</td> </tr> <tr> <td>VM2261A1</td> <td>TAPPO INF DX PORTA S6</td> <td>1</td> <td>PZ</td> </tr> <tr> <td>VM2305A0</td> <td>NOTTOLINO FISSAGGIO TAPPI PORTE MM</td> <td>3</td> <td>PZ</td> </tr> <tr> <th>Codice</th> <th>Descrizione</th> <th>Qtà</th> <th>UM</th> </tr> <tr> <td>OB1126A0</td> <td>TRAVERSO INFERIORE PORTA 860 M</td> <td>1</td> <td>PZ</td> </tr> <tr> <td>RC1200A0</td> <td>MOLLA A COMPRESSIO NE DE4 DF0.5 H24</td> <td>2</td> <td>PZ</td> </tr> <tr> <td>VI1220A1</td> <td>VITE AUTOFIETTA NTE 4.2X11 TCS+ MARUTE</td> <td>1</td> <td>PZ</td> </tr> <tr> <td>VI1996A0</td> <td>VITE M5X35 TCEI ZN</td> <td>7</td> <td>PZ</td> </tr> <tr> <td>VM1794A0</td> <td>FASCETTA 250X4.8 PA66 NERA</td> <td>2</td> <td>PZ</td> </tr> <tr> <td>VM2103A0</td> <td>PIASTRINA FERMAFASCE TTA</td> <td>2</td> <td>PZ</td> </tr> <tr> <td>VM2259A1</td> <td>TAPPO INF SX PORTA S6</td> <td>1</td> <td>PZ</td> </tr> <tr> <td>VM2261A1</td> <td>TAPPO INF DX PORTA S6</td> <td>1</td> <td>PZ</td> </tr> <tr> <td>VM2267A0</td> <td>CORSOIO SISTEMA FERMA VETRO INT</td> <td>1</td> <td>PZ</td> </tr> <tr> <td>VM2269A0</td> <td>TAPPO SISTEMA FERMA VETRO INT</td> <td>1</td> <td>PZ</td> </tr> <tr> <td>VM2274A0</td> <td>BOCCOLA SCANALATA</td> <td>1</td> <td>PZ</td> </tr> <tr> <td>VM2305A0</td> <td>NOTTOLINO FISSAGGIO TAPPI PORTE MM</td> <td>7</td> <td>PZ</td> </tr> </tbody> </table>	Codice	Descrizione	Qtà	UM	VI1996A0	VITE M5X35 TCEI ZN	3	PZ	VM2261A1	TAPPO INF DX PORTA S6	1	PZ	VM2305A0	NOTTOLINO FISSAGGIO TAPPI PORTE MM	3	PZ	Codice	Descrizione	Qtà	UM	OB1126A0	TRAVERSO INFERIORE PORTA 860 M	1	PZ	RC1200A0	MOLLA A COMPRESSIO NE DE4 DF0.5 H24	2	PZ	VI1220A1	VITE AUTOFIETTA NTE 4.2X11 TCS+ MARUTE	1	PZ	VI1996A0	VITE M5X35 TCEI ZN	7	PZ	VM1794A0	FASCETTA 250X4.8 PA66 NERA	2	PZ	VM2103A0	PIASTRINA FERMAFASCE TTA	2	PZ	VM2259A1	TAPPO INF SX PORTA S6	1	PZ	VM2261A1	TAPPO INF DX PORTA S6	1	PZ	VM2267A0	CORSOIO SISTEMA FERMA VETRO INT	1	PZ	VM2269A0	TAPPO SISTEMA FERMA VETRO INT	1	PZ	VM2274A0	BOCCOLA SCANALATA	1	PZ	VM2305A0	NOTTOLINO FISSAGGIO TAPPI PORTE MM	7	PZ
Codice	Descrizione	Qtà	UM																																																																						
VI1996A0	VITE M5X35 TCEI ZN	3	PZ																																																																						
VM2261A1	TAPPO INF DX PORTA S6	1	PZ																																																																						
VM2305A0	NOTTOLINO FISSAGGIO TAPPI PORTE MM	3	PZ																																																																						
Codice	Descrizione	Qtà	UM																																																																						
OB1126A0	TRAVERSO INFERIORE PORTA 860 M	1	PZ																																																																						
RC1200A0	MOLLA A COMPRESSIO NE DE4 DF0.5 H24	2	PZ																																																																						
VI1220A1	VITE AUTOFIETTA NTE 4.2X11 TCS+ MARUTE	1	PZ																																																																						
VI1996A0	VITE M5X35 TCEI ZN	7	PZ																																																																						
VM1794A0	FASCETTA 250X4.8 PA66 NERA	2	PZ																																																																						
VM2103A0	PIASTRINA FERMAFASCE TTA	2	PZ																																																																						
VM2259A1	TAPPO INF SX PORTA S6	1	PZ																																																																						
VM2261A1	TAPPO INF DX PORTA S6	1	PZ																																																																						
VM2267A0	CORSOIO SISTEMA FERMA VETRO INT	1	PZ																																																																						
VM2269A0	TAPPO SISTEMA FERMA VETRO INT	1	PZ																																																																						
VM2274A0	BOCCOLA SCANALATA	1	PZ																																																																						
VM2305A0	NOTTOLINO FISSAGGIO TAPPI PORTE MM	7	PZ																																																																						



COMPONENTE			RICAMBIO																																																						
Codice	Descrizione	Immagine	Codice	Descrizione	Lista componenti																																																				
VM2261A	TAPPO INF DX PORTA S6		K0B1126AL	KIT TRAVERSO INF PORTA BAKERTOP SX	<table border="1"> <thead> <tr> <th>Codice</th> <th>Descrizione</th> <th>Qtà</th> <th>UM</th> </tr> </thead> <tbody> <tr> <td>0B1126A0</td> <td>TRAVERSO INFERIORE PORTA 860 M</td> <td>1</td> <td>PZ</td> </tr> <tr> <td>RC1200A0</td> <td>MOLLA A COMPRESSIO NE DE4 DF0.5 H24</td> <td>2</td> <td>PZ</td> </tr> <tr> <td>VI1220A1</td> <td>VITE AUTOFILETTA NTE 4.2X11 TCS+ MARUTE</td> <td>1</td> <td>PZ</td> </tr> <tr> <td>VI1996A0</td> <td>VITE M5X35 TCEI ZN</td> <td>7</td> <td>PZ</td> </tr> <tr> <td>VM1794A0</td> <td>FASCETTA 250X4.8 PA66 NERA</td> <td>2</td> <td>PZ</td> </tr> <tr> <td>VM2103A0</td> <td>PIASTRINA FERMAFASCE TTA</td> <td>2</td> <td>PZ</td> </tr> <tr> <td>VM2267A0</td> <td>CORSOIO SISTEMA FERMA VETRO INT</td> <td>1</td> <td>PZ</td> </tr> <tr> <td>VM2269A0</td> <td>TAPPO SISTEMA FERMA VETRO INT</td> <td>1</td> <td>PZ</td> </tr> <tr> <td>VM2274A0</td> <td>BOCCOLA SCANALATA</td> <td>1</td> <td>PZ</td> </tr> <tr> <td>VM2305A0</td> <td>NOTTOLINO FISSAGGIO TAPPI PORTE MM</td> <td>7</td> <td>PZ</td> </tr> <tr> <td>VM2384A0</td> <td>TAPPO INF DX PORTA MM LEFT</td> <td>1</td> <td>PZ</td> </tr> <tr> <td>VM2386A1</td> <td>TAPPO INF SX PORTA MM LEFT</td> <td>1</td> <td>PZ</td> </tr> </tbody> </table>	Codice	Descrizione	Qtà	UM	0B1126A0	TRAVERSO INFERIORE PORTA 860 M	1	PZ	RC1200A0	MOLLA A COMPRESSIO NE DE4 DF0.5 H24	2	PZ	VI1220A1	VITE AUTOFILETTA NTE 4.2X11 TCS+ MARUTE	1	PZ	VI1996A0	VITE M5X35 TCEI ZN	7	PZ	VM1794A0	FASCETTA 250X4.8 PA66 NERA	2	PZ	VM2103A0	PIASTRINA FERMAFASCE TTA	2	PZ	VM2267A0	CORSOIO SISTEMA FERMA VETRO INT	1	PZ	VM2269A0	TAPPO SISTEMA FERMA VETRO INT	1	PZ	VM2274A0	BOCCOLA SCANALATA	1	PZ	VM2305A0	NOTTOLINO FISSAGGIO TAPPI PORTE MM	7	PZ	VM2384A0	TAPPO INF DX PORTA MM LEFT	1	PZ	VM2386A1	TAPPO INF SX PORTA MM LEFT	1	PZ
			Codice	Descrizione	Qtà	UM																																																			
0B1126A0	TRAVERSO INFERIORE PORTA 860 M	1	PZ																																																						
RC1200A0	MOLLA A COMPRESSIO NE DE4 DF0.5 H24	2	PZ																																																						
VI1220A1	VITE AUTOFILETTA NTE 4.2X11 TCS+ MARUTE	1	PZ																																																						
VI1996A0	VITE M5X35 TCEI ZN	7	PZ																																																						
VM1794A0	FASCETTA 250X4.8 PA66 NERA	2	PZ																																																						
VM2103A0	PIASTRINA FERMAFASCE TTA	2	PZ																																																						
VM2267A0	CORSOIO SISTEMA FERMA VETRO INT	1	PZ																																																						
VM2269A0	TAPPO SISTEMA FERMA VETRO INT	1	PZ																																																						
VM2274A0	BOCCOLA SCANALATA	1	PZ																																																						
VM2305A0	NOTTOLINO FISSAGGIO TAPPI PORTE MM	7	PZ																																																						
VM2384A0	TAPPO INF DX PORTA MM LEFT	1	PZ																																																						
VM2386A1	TAPPO INF SX PORTA MM LEFT	1	PZ																																																						
			K0B1122AR	KIT TRAVERSO INF. PORTA CHEFTOP D	<table border="1"> <thead> <tr> <th>Codice</th> <th>Descrizione</th> <th>Qtà</th> <th>UM</th> </tr> </thead> <tbody> <tr> <td>0B1122A0</td> <td>TRAVERSO INFERIORE PORTA 750 M</td> <td>1</td> <td>PZ</td> </tr> <tr> <td>RC1200A0</td> <td>MOLLA A COMPRESSIO NE DE4 DF0.5 H24</td> <td>2</td> <td>PZ</td> </tr> <tr> <td>VI1220A1</td> <td>VITE AUTOFILETTA NTE 4.2X11 TCS+ MARUTE</td> <td>1</td> <td>PZ</td> </tr> <tr> <td>VI1996A0</td> <td>VITE M5X35 TCEI ZN</td> <td>7</td> <td>PZ</td> </tr> </tbody> </table>	Codice	Descrizione	Qtà	UM	0B1122A0	TRAVERSO INFERIORE PORTA 750 M	1	PZ	RC1200A0	MOLLA A COMPRESSIO NE DE4 DF0.5 H24	2	PZ	VI1220A1	VITE AUTOFILETTA NTE 4.2X11 TCS+ MARUTE	1	PZ	VI1996A0	VITE M5X35 TCEI ZN	7	PZ																																
Codice	Descrizione	Qtà	UM																																																						
0B1122A0	TRAVERSO INFERIORE PORTA 750 M	1	PZ																																																						
RC1200A0	MOLLA A COMPRESSIO NE DE4 DF0.5 H24	2	PZ																																																						
VI1220A1	VITE AUTOFILETTA NTE 4.2X11 TCS+ MARUTE	1	PZ																																																						
VI1996A0	VITE M5X35 TCEI ZN	7	PZ																																																						

COMPONENTE			RICAMBIO																																							
Codice	Descrizione	Immagine	Codice	Descrizione	Lista componenti																																					
VM2261A	TAPPO INF DX PORTA S6		K0B1122AR	KIT TRAVERSO INF. PORTA CHEFTOP D	<table border="1"> <thead> <tr> <th>Codice</th> <th>Descrizione</th> <th>Qtà</th> <th>UM</th> </tr> </thead> <tbody> <tr> <td>VM1794A0</td> <td>FASCETTA 250X4.8 PA66 NERA</td> <td>2</td> <td>PZ</td> </tr> <tr> <td>VM2103A0</td> <td>PIASTRINA FERMAFASCE TTA</td> <td>2</td> <td>PZ</td> </tr> <tr> <td>VM2259A1</td> <td>TAPPO INF SX PORTA S6</td> <td>1</td> <td>PZ</td> </tr> <tr> <td>VM2261A1</td> <td>TAPPO INF DX PORTA S6</td> <td>1</td> <td>PZ</td> </tr> <tr> <td>VM2267A0</td> <td>CORSOIO SISTEMA FERMA VETRO INT</td> <td>1</td> <td>PZ</td> </tr> <tr> <td>VM2269A0</td> <td>TAPPO SISTEMA FERMA VETRO INT</td> <td>1</td> <td>PZ</td> </tr> <tr> <td>VM2274A0</td> <td>BOCCOLA SCANALATA</td> <td>1</td> <td>PZ</td> </tr> <tr> <td>VM2305A0</td> <td>NOTTOLINO FISSAGGIO TAPPI PORTE MM</td> <td>7</td> <td>PZ</td> </tr> </tbody> </table>	Codice	Descrizione	Qtà	UM	VM1794A0	FASCETTA 250X4.8 PA66 NERA	2	PZ	VM2103A0	PIASTRINA FERMAFASCE TTA	2	PZ	VM2259A1	TAPPO INF SX PORTA S6	1	PZ	VM2261A1	TAPPO INF DX PORTA S6	1	PZ	VM2267A0	CORSOIO SISTEMA FERMA VETRO INT	1	PZ	VM2269A0	TAPPO SISTEMA FERMA VETRO INT	1	PZ	VM2274A0	BOCCOLA SCANALATA	1	PZ	VM2305A0	NOTTOLINO FISSAGGIO TAPPI PORTE MM	7	PZ	
			Codice	Descrizione	Qtà	UM																																				
VM1794A0	FASCETTA 250X4.8 PA66 NERA	2	PZ																																							
VM2103A0	PIASTRINA FERMAFASCE TTA	2	PZ																																							
VM2259A1	TAPPO INF SX PORTA S6	1	PZ																																							
VM2261A1	TAPPO INF DX PORTA S6	1	PZ																																							
VM2267A0	CORSOIO SISTEMA FERMA VETRO INT	1	PZ																																							
VM2269A0	TAPPO SISTEMA FERMA VETRO INT	1	PZ																																							
VM2274A0	BOCCOLA SCANALATA	1	PZ																																							
VM2305A0	NOTTOLINO FISSAGGIO TAPPI PORTE MM	7	PZ																																							
K0B1122AL	KIT TRAVERSO INF. PORTA CHEFTOP MM SX	<table border="1"> <thead> <tr> <th>Codice</th> <th>Descrizione</th> <th>Qtà</th> <th>UM</th> </tr> </thead> <tbody> <tr> <td>0B1122A0</td> <td>TRAVERSO INFERIORE PORTA 750 M</td> <td>1</td> <td>PZ</td> </tr> <tr> <td>RC1200A0</td> <td>MOLLA A COMPRESSIO NE DE4 DF0.5 H24</td> <td>2</td> <td>PZ</td> </tr> <tr> <td>VI1220A1</td> <td>VITE AUTOFILETTA NTE 4.2X11 TCS+ MARUTE</td> <td>1</td> <td>PZ</td> </tr> <tr> <td>VI1996A0</td> <td>VITE M5X35 TCEI ZN</td> <td>7</td> <td>PZ</td> </tr> <tr> <td>VM1794A0</td> <td>FASCETTA 250X4.8 PA66 NERA</td> <td>2</td> <td>PZ</td> </tr> <tr> <td>VM2103A0</td> <td>PIASTRINA FERMAFASCE TTA</td> <td>2</td> <td>PZ</td> </tr> <tr> <td>VM2267A0</td> <td>CORSOIO SISTEMA FERMA VETRO INT</td> <td>1</td> <td>PZ</td> </tr> <tr> <td>VM2269A0</td> <td>TAPPO SISTEMA FERMA VETRO INT</td> <td>1</td> <td>PZ</td> </tr> <tr> <td>VM2274A0</td> <td>BOCCOLA SCANALATA</td> <td>1</td> <td>PZ</td> </tr> </tbody> </table>	Codice	Descrizione	Qtà	UM	0B1122A0	TRAVERSO INFERIORE PORTA 750 M	1	PZ	RC1200A0	MOLLA A COMPRESSIO NE DE4 DF0.5 H24	2	PZ	VI1220A1	VITE AUTOFILETTA NTE 4.2X11 TCS+ MARUTE	1	PZ	VI1996A0	VITE M5X35 TCEI ZN	7	PZ	VM1794A0	FASCETTA 250X4.8 PA66 NERA	2	PZ	VM2103A0	PIASTRINA FERMAFASCE TTA	2	PZ	VM2267A0	CORSOIO SISTEMA FERMA VETRO INT	1	PZ	VM2269A0	TAPPO SISTEMA FERMA VETRO INT	1	PZ	VM2274A0	BOCCOLA SCANALATA	1	PZ
Codice	Descrizione	Qtà	UM																																							
0B1122A0	TRAVERSO INFERIORE PORTA 750 M	1	PZ																																							
RC1200A0	MOLLA A COMPRESSIO NE DE4 DF0.5 H24	2	PZ																																							
VI1220A1	VITE AUTOFILETTA NTE 4.2X11 TCS+ MARUTE	1	PZ																																							
VI1996A0	VITE M5X35 TCEI ZN	7	PZ																																							
VM1794A0	FASCETTA 250X4.8 PA66 NERA	2	PZ																																							
VM2103A0	PIASTRINA FERMAFASCE TTA	2	PZ																																							
VM2267A0	CORSOIO SISTEMA FERMA VETRO INT	1	PZ																																							
VM2269A0	TAPPO SISTEMA FERMA VETRO INT	1	PZ																																							
VM2274A0	BOCCOLA SCANALATA	1	PZ																																							



COMPONENTE			RICAMBIO																						
Codice	Descrizione	Immagine	Codice	Descrizione	Lista componenti																				
VM2261A	TAPPO INF DX PORTA S6		K0B1122AL	KIT TRAVERSO INF. PORTA CHEFTOP MM SX	<table border="1"> <thead> <tr> <th>Codice</th> <th>Descrizione</th> <th>Qtà</th> <th>UM</th> </tr> </thead> <tbody> <tr> <td>VM2305A0</td> <td>NOTTOLINO FISSAGGIO TAPPI PORTE MM</td> <td>7</td> <td>PZ</td> </tr> <tr> <td>VM2384A0</td> <td>TAPPO INF DX PORTA MM LEFT</td> <td>1</td> <td>PZ</td> </tr> <tr> <td>VM2386A1</td> <td>TAPPO INF SX PORTA MM LEFT</td> <td>1</td> <td>PZ</td> </tr> </tbody> </table>	Codice	Descrizione	Qtà	UM	VM2305A0	NOTTOLINO FISSAGGIO TAPPI PORTE MM	7	PZ	VM2384A0	TAPPO INF DX PORTA MM LEFT	1	PZ	VM2386A1	TAPPO INF SX PORTA MM LEFT	1	PZ				
Codice	Descrizione	Qtà	UM																						
VM2305A0	NOTTOLINO FISSAGGIO TAPPI PORTE MM	7	PZ																						
VM2384A0	TAPPO INF DX PORTA MM LEFT	1	PZ																						
VM2386A1	TAPPO INF SX PORTA MM LEFT	1	PZ																						
VT1280A	VETRO INTERNO SER. XEVC-0511-E		KVT1280A	KIT VETRO INTERNO SINGOLO 0511	<table border="1"> <thead> <tr> <th>Codice</th> <th>Descrizione</th> <th>Qtà</th> <th>UM</th> </tr> </thead> <tbody> <tr> <td>IP1508A0</td> <td>POLISTIROLO PROFILO AD U 2000X60X60</td> <td>1</td> <td>PZ</td> </tr> <tr> <td>IP1508A1</td> <td>POLISTIROLO PROFILO AD U 2000X60X60</td> <td>1</td> <td>M</td> </tr> <tr> <td>VM1059A1</td> <td>FILM TERMORETRA IBILE H800</td> <td>1.500</td> <td>M</td> </tr> <tr> <td>VT1280A0</td> <td>VETRO INTERNO SER. XEVC-0511-E</td> <td>1</td> <td>PZ</td> </tr> </tbody> </table>	Codice	Descrizione	Qtà	UM	IP1508A0	POLISTIROLO PROFILO AD U 2000X60X60	1	PZ	IP1508A1	POLISTIROLO PROFILO AD U 2000X60X60	1	M	VM1059A1	FILM TERMORETRA IBILE H800	1.500	M	VT1280A0	VETRO INTERNO SER. XEVC-0511-E	1	PZ
Codice	Descrizione	Qtà	UM																						
IP1508A0	POLISTIROLO PROFILO AD U 2000X60X60	1	PZ																						
IP1508A1	POLISTIROLO PROFILO AD U 2000X60X60	1	M																						
VM1059A1	FILM TERMORETRA IBILE H800	1.500	M																						
VT1280A0	VETRO INTERNO SER. XEVC-0511-E	1	PZ																						
CR1103A	CERNIERA VETRO INTERNO INOX SUP		KCR1103A	KIT CERNIERA VETRO INTERNO INOX SUP	<table border="1"> <thead> <tr> <th>Codice</th> <th>Descrizione</th> <th>Qtà</th> <th>UM</th> </tr> </thead> <tbody> <tr> <td>CR1103A0</td> <td>CERNIERA VETRO INTERNO INOX SUP</td> <td>1</td> <td>PZ</td> </tr> <tr> <td>GN1182A0</td> <td>GUARNIZIONE CERN VETRO INT CR1103-1104</td> <td>1</td> <td>PZ</td> </tr> <tr> <td>GN1182A1</td> <td>GUARNIZIONE CERN VETRO INT CR1103-1104</td> <td>1</td> <td>PZ</td> </tr> <tr> <td>VI1810A0</td> <td>VITE NO TESTA EI M6X6 TESTA PIANA INOX</td> <td>3</td> <td>PZ</td> </tr> </tbody> </table>	Codice	Descrizione	Qtà	UM	CR1103A0	CERNIERA VETRO INTERNO INOX SUP	1	PZ	GN1182A0	GUARNIZIONE CERN VETRO INT CR1103-1104	1	PZ	GN1182A1	GUARNIZIONE CERN VETRO INT CR1103-1104	1	PZ	VI1810A0	VITE NO TESTA EI M6X6 TESTA PIANA INOX	3	PZ
Codice	Descrizione	Qtà	UM																						
CR1103A0	CERNIERA VETRO INTERNO INOX SUP	1	PZ																						
GN1182A0	GUARNIZIONE CERN VETRO INT CR1103-1104	1	PZ																						
GN1182A1	GUARNIZIONE CERN VETRO INT CR1103-1104	1	PZ																						
VI1810A0	VITE NO TESTA EI M6X6 TESTA PIANA INOX	3	PZ																						
VM2399A	COVER VITI SENZA TESTA CERNIERE PORTA		VM2399A0	COVER VITI SENZA TESTA CERNIERE PORTA																					







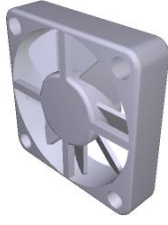



COMPONENTE			RICAMBIO																						
Codice	Descrizione	Immagine	Codice	Descrizione	Lista componenti																				
GN1182A	GUARNIZIONE CERN VETRO INT CR1103-1104		KG1182A	KIT 2 GUARN.CERNIERE VETRO INT CR1103-	<table border="1"> <thead> <tr> <th>Codice</th> <th>Descrizione</th> <th>Qtà</th> <th>UM</th> </tr> </thead> <tbody> <tr> <td>GN1182A0</td> <td>GUARNIZIONE CERN VETRO INT CR1103-1104</td> <td>2</td> <td>PZ</td> </tr> <tr> <td>GN1182A1</td> <td>GUARNIZIONE CERN VETRO INT CR1103-1104</td> <td>2</td> <td>PZ</td> </tr> </tbody> </table>	Codice	Descrizione	Qtà	UM	GN1182A0	GUARNIZIONE CERN VETRO INT CR1103-1104	2	PZ	GN1182A1	GUARNIZIONE CERN VETRO INT CR1103-1104	2	PZ								
Codice	Descrizione	Qtà	UM																						
GN1182A0	GUARNIZIONE CERN VETRO INT CR1103-1104	2	PZ																						
GN1182A1	GUARNIZIONE CERN VETRO INT CR1103-1104	2	PZ																						
CR1104A	CERNIERA VETRO INTERNO INOX INF		KCR1104A	KIT CERNIERA VETRO INTERNO INOX INF	<table border="1"> <thead> <tr> <th>Codice</th> <th>Descrizione</th> <th>Qtà</th> <th>UM</th> </tr> </thead> <tbody> <tr> <td>CR1104A0</td> <td>CERNIERA VETRO INTERNO INOX INF</td> <td>1</td> <td>PZ</td> </tr> <tr> <td>GN1182A0</td> <td>GUARNIZIONE CERN VETRO INT CR1103-1104</td> <td>1</td> <td>PZ</td> </tr> <tr> <td>GN1182A1</td> <td>GUARNIZIONE CERN VETRO INT CR1103-1104</td> <td>1</td> <td>PZ</td> </tr> <tr> <td>VI1810A0</td> <td>VITE NO TESTA EI M6X6 TESTA PIANA INOX</td> <td>3</td> <td>PZ</td> </tr> </tbody> </table>	Codice	Descrizione	Qtà	UM	CR1104A0	CERNIERA VETRO INTERNO INOX INF	1	PZ	GN1182A0	GUARNIZIONE CERN VETRO INT CR1103-1104	1	PZ	GN1182A1	GUARNIZIONE CERN VETRO INT CR1103-1104	1	PZ	VI1810A0	VITE NO TESTA EI M6X6 TESTA PIANA INOX	3	PZ
Codice	Descrizione	Qtà	UM																						
CR1104A0	CERNIERA VETRO INTERNO INOX INF	1	PZ																						
GN1182A0	GUARNIZIONE CERN VETRO INT CR1103-1104	1	PZ																						
GN1182A1	GUARNIZIONE CERN VETRO INT CR1103-1104	1	PZ																						
VI1810A0	VITE NO TESTA EI M6X6 TESTA PIANA INOX	3	PZ																						
VM2399A	COVER VITI SENZA TESTA CERNIERE PORTA		VM2399A0	COVER VITI SENZA TESTA CERNIERE PORTA																					
GN1182A	GUARNIZIONE CERN VETRO INT CR1103-1104		KG1182A	KIT 2 GUARN.CERNIERE VETRO INT CR1103-	<table border="1"> <thead> <tr> <th>Codice</th> <th>Descrizione</th> <th>Qtà</th> <th>UM</th> </tr> </thead> <tbody> <tr> <td>GN1182A0</td> <td>GUARNIZIONE CERN VETRO INT CR1103-1104</td> <td>2</td> <td>PZ</td> </tr> <tr> <td>GN1182A1</td> <td>GUARNIZIONE CERN VETRO INT CR1103-1104</td> <td>2</td> <td>PZ</td> </tr> </tbody> </table>	Codice	Descrizione	Qtà	UM	GN1182A0	GUARNIZIONE CERN VETRO INT CR1103-1104	2	PZ	GN1182A1	GUARNIZIONE CERN VETRO INT CR1103-1104	2	PZ								
Codice	Descrizione	Qtà	UM																						
GN1182A0	GUARNIZIONE CERN VETRO INT CR1103-1104	2	PZ																						
GN1182A1	GUARNIZIONE CERN VETRO INT CR1103-1104	2	PZ																						

COMPONENTE			RICAMBIO																																										
Codice	Descrizione	Immagine	Codice	Descrizione	Lista componenti																																								
VM2315A	SUPPORTO SPINGI VETRO INT MM		KVM2315A	KIT SUPPORTO SPINGI VETRO INT MM	<table border="1"> <thead> <tr> <th>Codice</th> <th>Descrizione</th> <th>Qtà</th> <th>UM</th> </tr> </thead> <tbody> <tr> <td>VI1220A1</td> <td>VITE AUTOFIILETTA NTE 4.2X11 TCS+ MARUTE</td> <td>3</td> <td>PZ</td> </tr> <tr> <td>VM1630A0</td> <td>TAPPO PREMI VETRO INTERNO</td> <td>3</td> <td>PZ</td> </tr> <tr> <td>VM2315A0</td> <td>SUPPORTO SPINGI VETRO INT MM</td> <td>3</td> <td>PZ</td> </tr> </tbody> </table>	Codice	Descrizione	Qtà	UM	VI1220A1	VITE AUTOFIILETTA NTE 4.2X11 TCS+ MARUTE	3	PZ	VM1630A0	TAPPO PREMI VETRO INTERNO	3	PZ	VM2315A0	SUPPORTO SPINGI VETRO INT MM	3	PZ																								
Codice	Descrizione	Qtà	UM																																										
VI1220A1	VITE AUTOFIILETTA NTE 4.2X11 TCS+ MARUTE	3	PZ																																										
VM1630A0	TAPPO PREMI VETRO INTERNO	3	PZ																																										
VM2315A0	SUPPORTO SPINGI VETRO INT MM	3	PZ																																										
VM1630A	TAPPO PREMI VETRO INTERNO		KVM2315A  KVM1591A  KVM1590A	KIT SUPPORTO SPINGI VETRO INT MM  KIT SPINGIVETRO INTERNO H35 S.5E  KIT SPINGIVETRO INTERNO H25 S.5	<table border="1"> <thead> <tr> <th>Codice</th> <th>Descrizione</th> <th>Qtà</th> <th>UM</th> </tr> </thead> <tbody> <tr> <td>VI1220A1</td> <td>VITE AUTOFIILETTA NTE 4.2X11 TCS+ MARUTE</td> <td>3</td> <td>PZ</td> </tr> <tr> <td>VM1630A0</td> <td>TAPPO PREMI VETRO INTERNO</td> <td>3</td> <td>PZ</td> </tr> <tr> <td>VM2315A0</td> <td>SUPPORTO SPINGI VETRO INT MM</td> <td>3</td> <td>PZ</td> </tr> <tr> <td>VI1220A1</td> <td>VITE AUTOFIILETTA NTE 4.2X11 TCS+ MARUTE</td> <td>2</td> <td>PZ</td> </tr> <tr> <td>VM1591A0</td> <td>STAFFA SPINGIVETRO INTERNO XVC1004</td> <td>1</td> <td>PZ</td> </tr> <tr> <td>VM1630A0</td> <td>TAPPO PREMI VETRO INTERNO</td> <td>2</td> <td>PZ</td> </tr> <tr> <td>VI1220A1</td> <td>VITE AUTOFIILETTA NTE 4.2X11 TCS+ MARUTE</td> <td>2</td> <td>PZ</td> </tr> <tr> <td>VM1590A0</td> <td>STAFFA SPINGIVETRO INTERNO XVC705 XBC80</td> <td>1</td> <td>PZ</td> </tr> <tr> <td>VM1630A0</td> <td>TAPPO PREMI VETRO INTERNO</td> <td>2</td> <td>PZ</td> </tr> </tbody> </table>	Codice	Descrizione	Qtà	UM	VI1220A1	VITE AUTOFIILETTA NTE 4.2X11 TCS+ MARUTE	3	PZ	VM1630A0	TAPPO PREMI VETRO INTERNO	3	PZ	VM2315A0	SUPPORTO SPINGI VETRO INT MM	3	PZ	VI1220A1	VITE AUTOFIILETTA NTE 4.2X11 TCS+ MARUTE	2	PZ	VM1591A0	STAFFA SPINGIVETRO INTERNO XVC1004	1	PZ	VM1630A0	TAPPO PREMI VETRO INTERNO	2	PZ	VI1220A1	VITE AUTOFIILETTA NTE 4.2X11 TCS+ MARUTE	2	PZ	VM1590A0	STAFFA SPINGIVETRO INTERNO XVC705 XBC80	1	PZ	VM1630A0	TAPPO PREMI VETRO INTERNO	2	PZ
Codice	Descrizione	Qtà	UM																																										
VI1220A1	VITE AUTOFIILETTA NTE 4.2X11 TCS+ MARUTE	3	PZ																																										
VM1630A0	TAPPO PREMI VETRO INTERNO	3	PZ																																										
VM2315A0	SUPPORTO SPINGI VETRO INT MM	3	PZ																																										
VI1220A1	VITE AUTOFIILETTA NTE 4.2X11 TCS+ MARUTE	2	PZ																																										
VM1591A0	STAFFA SPINGIVETRO INTERNO XVC1004	1	PZ																																										
VM1630A0	TAPPO PREMI VETRO INTERNO	2	PZ																																										
VI1220A1	VITE AUTOFIILETTA NTE 4.2X11 TCS+ MARUTE	2	PZ																																										
VM1590A0	STAFFA SPINGIVETRO INTERNO XVC705 XBC80	1	PZ																																										
VM1630A0	TAPPO PREMI VETRO INTERNO	2	PZ																																										



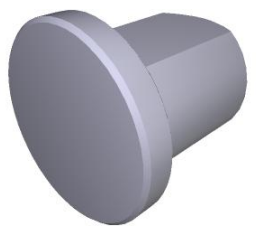

COMPONENTE			RICAMBIO																						
Codice	Descrizione	Immagine	Codice	Descrizione	Lista componenti																				
VM2284A	PROFILO SALVAGOCCE SERIE 750		KVM2284A	KIT PROFILO SALVAGOCCE SERIE 750	<table border="1"> <thead> <tr> <th>Codice</th> <th>Descrizione</th> <th>Qtà</th> <th>UM</th> </tr> </thead> <tbody> <tr> <td>VM2284A0</td> <td>PROFILO SALVAGOCCE SERIE 750</td> <td>1</td> <td>PZ</td> </tr> </tbody> </table>	Codice	Descrizione	Qtà	UM	VM2284A0	PROFILO SALVAGOCCE SERIE 750	1	PZ												
Codice	Descrizione	Qtà	UM																						
VM2284A0	PROFILO SALVAGOCCE SERIE 750	1	PZ																						
VM2312A	TUBETTO SX SCARICO GOCCIOLATOIO MM		KVM2312A	KIT TUBETTO SX SCARICO GOCCIOLATOIO MM	<table border="1"> <thead> <tr> <th>Codice</th> <th>Descrizione</th> <th>Qtà</th> <th>UM</th> </tr> </thead> <tbody> <tr> <td>VM2312A0</td> <td>TUBETTO SX SCARICO GOCCIOLATOIO O MM</td> <td>1</td> <td>PZ</td> </tr> </tbody> </table>	Codice	Descrizione	Qtà	UM	VM2312A0	TUBETTO SX SCARICO GOCCIOLATOIO O MM	1	PZ												
Codice	Descrizione	Qtà	UM																						
VM2312A0	TUBETTO SX SCARICO GOCCIOLATOIO O MM	1	PZ																						
VM2314A	TAPPINO GOCCIOLATOIO MM		KVM2314A	KIT TAPPINO GOCCIOLATOIO MIND.MAPS	<table border="1"> <thead> <tr> <th>Codice</th> <th>Descrizione</th> <th>Qtà</th> <th>UM</th> </tr> </thead> <tbody> <tr> <td>VM2314A0</td> <td>TAPPINO GOCCIOLATOIO O MM</td> <td>1</td> <td>PZ</td> </tr> </tbody> </table>	Codice	Descrizione	Qtà	UM	VM2314A0	TAPPINO GOCCIOLATOIO O MM	1	PZ												
Codice	Descrizione	Qtà	UM																						
VM2314A0	TAPPINO GOCCIOLATOIO O MM	1	PZ																						
LP1019A	BARRA ILLUMINAZIONE LED MM L200 E415		KLP1019A	KIT RICAMBIO BARRA LED MM L200 E415	<table border="1"> <thead> <tr> <th>Codice</th> <th>Descrizione</th> <th>Qtà</th> <th>UM</th> </tr> </thead> <tbody> <tr> <td>IP1385A1</td> <td>IMB POL ANGOLARE 110X80X2000 D30</td> <td>0.900</td> <td>M</td> </tr> <tr> <td>LP1019A0</td> <td>BARRA ILLUMINAZION E LED MM L200 E415</td> <td>1</td> <td>PZ</td> </tr> <tr> <td>VM1058A1</td> <td>FILM TERMORETRA IBILE H410</td> <td>0.900</td> <td>M</td> </tr> <tr> <td>VM1059A1</td> <td>FILM TERMORETRA IBILE H800</td> <td>0.900</td> <td>M</td> </tr> </tbody> </table>	Codice	Descrizione	Qtà	UM	IP1385A1	IMB POL ANGOLARE 110X80X2000 D30	0.900	M	LP1019A0	BARRA ILLUMINAZION E LED MM L200 E415	1	PZ	VM1058A1	FILM TERMORETRA IBILE H410	0.900	M	VM1059A1	FILM TERMORETRA IBILE H800	0.900	M
Codice	Descrizione	Qtà	UM																						
IP1385A1	IMB POL ANGOLARE 110X80X2000 D30	0.900	M																						
LP1019A0	BARRA ILLUMINAZION E LED MM L200 E415	1	PZ																						
VM1058A1	FILM TERMORETRA IBILE H410	0.900	M																						
VM1059A1	FILM TERMORETRA IBILE H800	0.900	M																						

COMPONENTE			RICAMBIO																						
Codice	Descrizione	Immagine	Codice	Descrizione	Lista componenti																				
LP1025A	ESTRUSO ILLUMINAZIONE NO LED MM L415		KLP1025A	KIT ESTRUSO ILLUMINAZIONE NO LED MM L415	<table border="1"> <thead> <tr> <th>Codice</th> <th>Descrizione</th> <th>Qtà</th> <th>UM</th> </tr> </thead> <tbody> <tr> <td>IP1385A1</td> <td>IMB POL ANGOLARE 110X80X2000 D30</td> <td>0.900</td> <td>M</td> </tr> <tr> <td>LP1025A0</td> <td>ESTRUSO ILLUMINAZIONE E NO LED MM L415</td> <td>1</td> <td>PZ</td> </tr> <tr> <td>VM1058A1</td> <td>FILM TERMORETRA IBILE H410</td> <td>0.900</td> <td>M</td> </tr> <tr> <td>VM1059A1</td> <td>FILM TERMORETRA IBILE H800</td> <td>0.900</td> <td>M</td> </tr> </tbody> </table>	Codice	Descrizione	Qtà	UM	IP1385A1	IMB POL ANGOLARE 110X80X2000 D30	0.900	M	LP1025A0	ESTRUSO ILLUMINAZIONE E NO LED MM L415	1	PZ	VM1058A1	FILM TERMORETRA IBILE H410	0.900	M	VM1059A1	FILM TERMORETRA IBILE H800	0.900	M
Codice	Descrizione	Qtà	UM																						
IP1385A1	IMB POL ANGOLARE 110X80X2000 D30	0.900	M																						
LP1025A0	ESTRUSO ILLUMINAZIONE E NO LED MM L415	1	PZ																						
VM1058A1	FILM TERMORETRA IBILE H410	0.900	M																						
VM1059A1	FILM TERMORETRA IBILE H800	0.900	M																						
VN1177A	VENTIL ASSIALE 40X40X10MM 12VCC		KVN1179A	KIT VENTIL ASSIALE 40X40X20MM 12VCC	<table border="1"> <thead> <tr> <th>Codice</th> <th>Descrizione</th> <th>Qtà</th> <th>UM</th> </tr> </thead> <tbody> <tr> <td>VN1179A0</td> <td>VENTIL ASSIALE 40X40X20MM 12VCC</td> <td>1</td> <td>PZ</td> </tr> </tbody> </table>	Codice	Descrizione	Qtà	UM	VN1179A0	VENTIL ASSIALE 40X40X20MM 12VCC	1	PZ												
Codice	Descrizione	Qtà	UM																						
VN1179A0	VENTIL ASSIALE 40X40X20MM 12VCC	1	PZ																						
			KVN1177A	KIT VENTIL ASSIALE 40X40X10MM 12VCC	<table border="1"> <thead> <tr> <th>Codice</th> <th>Descrizione</th> <th>Qtà</th> <th>UM</th> </tr> </thead> <tbody> <tr> <td>VN1177A0</td> <td>VENTIL ASSIALE 40X40X10MM 12VCC</td> <td>1</td> <td>PZ</td> </tr> </tbody> </table>	Codice	Descrizione	Qtà	UM	VN1177A0	VENTIL ASSIALE 40X40X10MM 12VCC	1	PZ												
Codice	Descrizione	Qtà	UM																						
VN1177A0	VENTIL ASSIALE 40X40X10MM 12VCC	1	PZ																						
VM2316A	SUPPORTO VENTOLA RAFF. CRUSCOTTO		KVM2518A	KIT SUPPORTO VENTOLA RAFF CRUS 20X20 H20	<table border="1"> <thead> <tr> <th>Codice</th> <th>Descrizione</th> <th>Qtà</th> <th>UM</th> </tr> </thead> <tbody> <tr> <td>VM2518A0</td> <td>SUPPORTO VENTOLA RAFF CRUS 20X20 H20</td> <td>1</td> <td>PZ</td> </tr> </tbody> </table>	Codice	Descrizione	Qtà	UM	VM2518A0	SUPPORTO VENTOLA RAFF CRUS 20X20 H20	1	PZ												
Codice	Descrizione	Qtà	UM																						
VM2518A0	SUPPORTO VENTOLA RAFF CRUS 20X20 H20	1	PZ																						
			KVM2316A	KIT SUPPORTO VENTOLA RAFF. CRUSCOTTO	<table border="1"> <thead> <tr> <th>Codice</th> <th>Descrizione</th> <th>Qtà</th> <th>UM</th> </tr> </thead> <tbody> <tr> <td>VM2316A0</td> <td>SUPPORTO VENTOLA RAFF. CRUSCOTTO</td> <td>1</td> <td>PZ</td> </tr> </tbody> </table>	Codice	Descrizione	Qtà	UM	VM2316A0	SUPPORTO VENTOLA RAFF. CRUSCOTTO	1	PZ												
Codice	Descrizione	Qtà	UM																						
VM2316A0	SUPPORTO VENTOLA RAFF. CRUSCOTTO	1	PZ																						
CE1285A	FERRITE EMI ROUND MOD. 2643801502																								

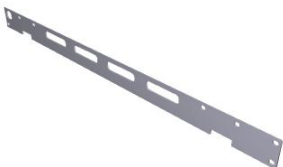
COMPONENTE			RICAMBIO																														
Codice	Descrizione	Immagine	Codice	Descrizione	Lista componenti																												
CE1275A	CAVO COLLEGAMENTO POTENZA CONTROLLO 3 M		KCE1275A	KIT CAVO COLLEGAMENTO	<table border="1"> <thead> <tr> <th>Codice</th> <th>Descrizione</th> <th>Qtà</th> <th>UM</th> </tr> </thead> <tbody> <tr> <td>CE1285A0</td> <td>FERRITE EMI ROUND MOD. 2643801502</td> <td>1</td> <td>PZ</td> </tr> <tr> <td>CE1290A0</td> <td>MORSETTO FEMMINA ESTRAIBILE CPF 5/4</td> <td>1</td> <td>PZ</td> </tr> <tr> <td>CE1455A0</td> <td>TERMINALE A PUNTALE</td> <td>4</td> <td>PZ</td> </tr> <tr> <td>CE1725A0</td> <td>CAVO SILICONICO PER ROBOTICA 4 X 0.5 MMQ</td> <td>3</td> <td>M</td> </tr> <tr> <td>CE1735A0</td> <td>TERMINALE MINIFIT FEMMINA</td> <td>4</td> <td>PZ</td> </tr> <tr> <td>CE1755A0</td> <td>CONNETTORE MINIFIT MASCHIO 4 VI</td> <td>1</td> <td>PZ</td> </tr> </tbody> </table>	Codice	Descrizione	Qtà	UM	CE1285A0	FERRITE EMI ROUND MOD. 2643801502	1	PZ	CE1290A0	MORSETTO FEMMINA ESTRAIBILE CPF 5/4	1	PZ	CE1455A0	TERMINALE A PUNTALE	4	PZ	CE1725A0	CAVO SILICONICO PER ROBOTICA 4 X 0.5 MMQ	3	M	CE1735A0	TERMINALE MINIFIT FEMMINA	4	PZ	CE1755A0	CONNETTORE MINIFIT MASCHIO 4 VI	1	PZ
Codice	Descrizione	Qtà	UM																														
CE1285A0	FERRITE EMI ROUND MOD. 2643801502	1	PZ																														
CE1290A0	MORSETTO FEMMINA ESTRAIBILE CPF 5/4	1	PZ																														
CE1455A0	TERMINALE A PUNTALE	4	PZ																														
CE1725A0	CAVO SILICONICO PER ROBOTICA 4 X 0.5 MMQ	3	M																														
CE1735A0	TERMINALE MINIFIT FEMMINA	4	PZ																														
CE1755A0	CONNETTORE MINIFIT MASCHIO 4 VI	1	PZ																														
0B1106A	COLONNINA ESTERNA SX PORTA XEVC-0511-E		0B1106A0	COLONNINA ESTERNA SX PORTA XEVC-0511-E																													
0B1108A	COLONNINA ESTERNA DX PORTA XEVC-0511-E		0B1108A0	COLONNINA ESTERNA DX PORTA XEVC-0511-E																													
CE1053B	CAVO ALIMENT BARRA LED MM MICROFIT 2P																																

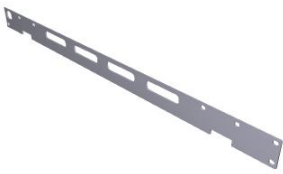
COMPONENTE			RICAMBIO														
Codice	Descrizione	Immagine	Codice	Descrizione	Lista componenti												
CE1052A	CAVO CONNESSIONE CONTROLLO-USB MM 750MM		KCE1052A	KIT CAVO CONN CONTROLLO-USB MM 650	<table border="1"> <thead> <tr> <th>Codice</th> <th>Descrizione</th> <th>Qtà</th> <th>UM</th> </tr> </thead> <tbody> <tr> <td>CE1052A0</td> <td>CAVO CONNESSION E CONTROLLO- USB MM 650M</td> <td>1</td> <td>PZ</td> </tr> <tr> <td>CE1052A1</td> <td>CAVO CONNESSION E CONTROLLO- USB MM 750M</td> <td>1</td> <td>PZ</td> </tr> </tbody> </table>	Codice	Descrizione	Qtà	UM	CE1052A0	CAVO CONNESSION E CONTROLLO- USB MM 650M	1	PZ	CE1052A1	CAVO CONNESSION E CONTROLLO- USB MM 750M	1	PZ
Codice	Descrizione	Qtà	UM														
CE1052A0	CAVO CONNESSION E CONTROLLO- USB MM 650M	1	PZ														
CE1052A1	CAVO CONNESSION E CONTROLLO- USB MM 750M	1	PZ														
0B1216A	TRAVERSO SUPERIORE PORTA 750 MM 2V		0B1216A0	TRAVERSO SUPERIORE PORTA 750 MM 2V													
VM2305A	NOTTOLINO FISSAGGIO TAPPI PORTE MM		VM2305A0	NOTTOLINO FISSAGGIO TAPPI PORTE MM													
VM2275A	BOCCOLA LISCIA		KVM2275A	KIT BOCCOLA LISCIA VM2275A0	<table border="1"> <thead> <tr> <th>Codice</th> <th>Descrizione</th> <th>Qtà</th> <th>UM</th> </tr> </thead> <tbody> <tr> <td>VM2275A0</td> <td>BOCCOLA LISCIA</td> <td>1</td> <td>PZ</td> </tr> </tbody> </table>	Codice	Descrizione	Qtà	UM	VM2275A0	BOCCOLA LISCIA	1	PZ				
Codice	Descrizione	Qtà	UM														
VM2275A0	BOCCOLA LISCIA	1	PZ														
VM2260A	TAPPO SUP SX PORTA S6		KVM2260A	KIT TAPPO SUP SX PORTA MIND MAPS	<table border="1"> <thead> <tr> <th>Codice</th> <th>Descrizione</th> <th>Qtà</th> <th>UM</th> </tr> </thead> <tbody> <tr> <td>VM2260A1</td> <td>TAPPO SUP SX PORTA S6</td> <td>1</td> <td>PZ</td> </tr> </tbody> </table>	Codice	Descrizione	Qtà	UM	VM2260A1	TAPPO SUP SX PORTA S6	1	PZ				
Codice	Descrizione	Qtà	UM														
VM2260A1	TAPPO SUP SX PORTA S6	1	PZ														

COMPONENTE			RICAMBIO																																																																																	
Codice	Descrizione	Immagine	Codice	Descrizione	Lista componenti																																																																															
0B1122A	TRAVERSO INFERIORE PORTA 750 MM		K0B1122AR	KIT TRAVERSO INF. PORTA CHEFTOP D	<table border="1"> <thead> <tr> <th>Codice</th> <th>Descrizione</th> <th>Qtà</th> <th>UM</th> </tr> </thead> <tbody> <tr> <td>0B1122A0</td> <td>TRAVERSO INFERIORE PORTA 750 M</td> <td>1</td> <td>PZ</td> </tr> <tr> <td>RC1200A0</td> <td>MOLLA A COMPRESSIO NE DE4 DF0.5 H24</td> <td>2</td> <td>PZ</td> </tr> <tr> <td>VI1220A1</td> <td>VITE AUTOFIETTA NTE 4.2X11 TCS+ MARUTE</td> <td>1</td> <td>PZ</td> </tr> <tr> <td>VI1996A0</td> <td>VITE M5X35 TCEI ZN</td> <td>7</td> <td>PZ</td> </tr> <tr> <td>VM1794A0</td> <td>FASCETTA 250X4.8 PA66 NERA</td> <td>2</td> <td>PZ</td> </tr> <tr> <td>VM2103A0</td> <td>PIASTRINA FERMAFASCE TTA</td> <td>2</td> <td>PZ</td> </tr> <tr> <td>VM2259A1</td> <td>TAPPO INF SX PORTA S6</td> <td>1</td> <td>PZ</td> </tr> <tr> <td>VM2261A1</td> <td>TAPPO INF DX PORTA S6</td> <td>1</td> <td>PZ</td> </tr> <tr> <td>VM2267A0</td> <td>CORSOIO SISTEMA FERMA VETRO INT</td> <td>1</td> <td>PZ</td> </tr> <tr> <td>VM2269A0</td> <td>TAPPO SISTEMA FERMA VETRO INT</td> <td>1</td> <td>PZ</td> </tr> <tr> <td>VM2274A0</td> <td>BOCCOLA SCANALATA</td> <td>1</td> <td>PZ</td> </tr> <tr> <td>VM2305A0</td> <td>NOTTOLINO FISSAGGIO TAPPI PORTE MM</td> <td>7</td> <td>PZ</td> </tr> </tbody> </table>	Codice	Descrizione	Qtà	UM	0B1122A0	TRAVERSO INFERIORE PORTA 750 M	1	PZ	RC1200A0	MOLLA A COMPRESSIO NE DE4 DF0.5 H24	2	PZ	VI1220A1	VITE AUTOFIETTA NTE 4.2X11 TCS+ MARUTE	1	PZ	VI1996A0	VITE M5X35 TCEI ZN	7	PZ	VM1794A0	FASCETTA 250X4.8 PA66 NERA	2	PZ	VM2103A0	PIASTRINA FERMAFASCE TTA	2	PZ	VM2259A1	TAPPO INF SX PORTA S6	1	PZ	VM2261A1	TAPPO INF DX PORTA S6	1	PZ	VM2267A0	CORSOIO SISTEMA FERMA VETRO INT	1	PZ	VM2269A0	TAPPO SISTEMA FERMA VETRO INT	1	PZ	VM2274A0	BOCCOLA SCANALATA	1	PZ	VM2305A0	NOTTOLINO FISSAGGIO TAPPI PORTE MM	7	PZ	K0B1122AL	KIT TRAVERSO INF. PORTA CHEFTOP MM SX	<table border="1"> <thead> <tr> <th>Codice</th> <th>Descrizione</th> <th>Qtà</th> <th>UM</th> </tr> </thead> <tbody> <tr> <td>0B1122A0</td> <td>TRAVERSO INFERIORE PORTA 750 M</td> <td>1</td> <td>PZ</td> </tr> <tr> <td>RC1200A0</td> <td>MOLLA A COMPRESSIO NE DE4 DF0.5 H24</td> <td>2</td> <td>PZ</td> </tr> <tr> <td>VI1220A1</td> <td>VITE AUTOFIETTA NTE 4.2X11 TCS+ MARUTE</td> <td>1</td> <td>PZ</td> </tr> <tr> <td>VI1996A0</td> <td>VITE M5X35 TCEI ZN</td> <td>7</td> <td>PZ</td> </tr> <tr> <td>VM1794A0</td> <td>FASCETTA 250X4.8 PA66 NERA</td> <td>2</td> <td>PZ</td> </tr> </tbody> </table>	Codice	Descrizione	Qtà	UM	0B1122A0	TRAVERSO INFERIORE PORTA 750 M	1	PZ	RC1200A0	MOLLA A COMPRESSIO NE DE4 DF0.5 H24	2	PZ	VI1220A1	VITE AUTOFIETTA NTE 4.2X11 TCS+ MARUTE	1	PZ	VI1996A0	VITE M5X35 TCEI ZN	7	PZ	VM1794A0	FASCETTA 250X4.8 PA66 NERA	2	PZ
			Codice	Descrizione	Qtà	UM																																																																														
0B1122A0	TRAVERSO INFERIORE PORTA 750 M	1	PZ																																																																																	
RC1200A0	MOLLA A COMPRESSIO NE DE4 DF0.5 H24	2	PZ																																																																																	
VI1220A1	VITE AUTOFIETTA NTE 4.2X11 TCS+ MARUTE	1	PZ																																																																																	
VI1996A0	VITE M5X35 TCEI ZN	7	PZ																																																																																	
VM1794A0	FASCETTA 250X4.8 PA66 NERA	2	PZ																																																																																	
VM2103A0	PIASTRINA FERMAFASCE TTA	2	PZ																																																																																	
VM2259A1	TAPPO INF SX PORTA S6	1	PZ																																																																																	
VM2261A1	TAPPO INF DX PORTA S6	1	PZ																																																																																	
VM2267A0	CORSOIO SISTEMA FERMA VETRO INT	1	PZ																																																																																	
VM2269A0	TAPPO SISTEMA FERMA VETRO INT	1	PZ																																																																																	
VM2274A0	BOCCOLA SCANALATA	1	PZ																																																																																	
VM2305A0	NOTTOLINO FISSAGGIO TAPPI PORTE MM	7	PZ																																																																																	
Codice	Descrizione	Qtà	UM																																																																																	
0B1122A0	TRAVERSO INFERIORE PORTA 750 M	1	PZ																																																																																	
RC1200A0	MOLLA A COMPRESSIO NE DE4 DF0.5 H24	2	PZ																																																																																	
VI1220A1	VITE AUTOFIETTA NTE 4.2X11 TCS+ MARUTE	1	PZ																																																																																	
VI1996A0	VITE M5X35 TCEI ZN	7	PZ																																																																																	
VM1794A0	FASCETTA 250X4.8 PA66 NERA	2	PZ																																																																																	

COMPONENTE			RICAMBIO																																		
Codice	Descrizione	Immagine	Codice	Descrizione	Lista componenti																																
0B1122A	TRAVERSO INFERIORE PORTA 750 MM		K0B1122AL	KIT TRAVERSO INF. PORTA CHEFTOP MM SX	<table border="1"> <thead> <tr> <th>Codice</th> <th>Descrizione</th> <th>Qtà</th> <th>UM</th> </tr> </thead> <tbody> <tr> <td>VM2103A0</td> <td>PIASTRINA FERMAFASCE TTA</td> <td>2</td> <td>PZ</td> </tr> <tr> <td>VM2267A0</td> <td>CORSOIO SISTEMA FERMA VETRO INT</td> <td>1</td> <td>PZ</td> </tr> <tr> <td>VM2269A0</td> <td>TAPPO SISTEMA FERMA VETRO INT</td> <td>1</td> <td>PZ</td> </tr> <tr> <td>VM2274A0</td> <td>BOCCOLA SCANALATA</td> <td>1</td> <td>PZ</td> </tr> <tr> <td>VM2305A0</td> <td>NOTTOLINO FISSAGGIO TAPPI PORTE MM</td> <td>7</td> <td>PZ</td> </tr> <tr> <td>VM2384A0</td> <td>TAPPO INF DX PORTA MM LEFT</td> <td>1</td> <td>PZ</td> </tr> <tr> <td>VM2386A1</td> <td>TAPPO INF SX PORTA MM LEFT</td> <td>1</td> <td>PZ</td> </tr> </tbody> </table>	Codice	Descrizione	Qtà	UM	VM2103A0	PIASTRINA FERMAFASCE TTA	2	PZ	VM2267A0	CORSOIO SISTEMA FERMA VETRO INT	1	PZ	VM2269A0	TAPPO SISTEMA FERMA VETRO INT	1	PZ	VM2274A0	BOCCOLA SCANALATA	1	PZ	VM2305A0	NOTTOLINO FISSAGGIO TAPPI PORTE MM	7	PZ	VM2384A0	TAPPO INF DX PORTA MM LEFT	1	PZ	VM2386A1	TAPPO INF SX PORTA MM LEFT	1	PZ
Codice	Descrizione	Qtà	UM																																		
VM2103A0	PIASTRINA FERMAFASCE TTA	2	PZ																																		
VM2267A0	CORSOIO SISTEMA FERMA VETRO INT	1	PZ																																		
VM2269A0	TAPPO SISTEMA FERMA VETRO INT	1	PZ																																		
VM2274A0	BOCCOLA SCANALATA	1	PZ																																		
VM2305A0	NOTTOLINO FISSAGGIO TAPPI PORTE MM	7	PZ																																		
VM2384A0	TAPPO INF DX PORTA MM LEFT	1	PZ																																		
VM2386A1	TAPPO INF SX PORTA MM LEFT	1	PZ																																		
0B1217A	TRAVERSO SUPERIORE INT PORTA 750 S6 2V																																				
0B1107A	COLONNINA INTERNA SX PORTA XEVC-0511-E																																				
0B1109A	COLONNINA INTERNA DX PORTA XEVC-0511-E																																				



COMPONENTE			RICAMBIO																										
Codice	Descrizione	Immagine	Codice	Descrizione	Lista componenti																								
PE2046A	ASSIEME SUPPORTO USB-RESET MM		KPE2046A	KIT ASSIEME SUPPORTO USB-RESET MM	<table border="1"> <thead> <tr> <th>Codice</th> <th>Descrizione</th> <th>Qtà</th> <th>UM</th> </tr> </thead> <tbody> <tr> <td>PE2046A0</td> <td>ASSIEME SUPPORTO USB-RESET M</td> <td>1</td> <td>PZ</td> </tr> <tr> <td>PE2046A1</td> <td>ASSIEME SUPPORTO USB-RESET M</td> <td>1</td> <td>PZ</td> </tr> <tr> <td>PE2046A2</td> <td>ASSIEME SUPPORTO USB-RESET M</td> <td>1</td> <td>PZ</td> </tr> <tr> <td>VI1220A1</td> <td>VITE AUTOFILETTA NTE 4.2X11 TCS+ MARUTE</td> <td>2</td> <td>PZ</td> </tr> <tr> <td>VM2147A0</td> <td>SPUGNA ESD ROSA LISCIA 410X343X15 M</td> <td>0.250</td> <td>PZ</td> </tr> </tbody> </table>	Codice	Descrizione	Qtà	UM	PE2046A0	ASSIEME SUPPORTO USB-RESET M	1	PZ	PE2046A1	ASSIEME SUPPORTO USB-RESET M	1	PZ	PE2046A2	ASSIEME SUPPORTO USB-RESET M	1	PZ	VI1220A1	VITE AUTOFILETTA NTE 4.2X11 TCS+ MARUTE	2	PZ	VM2147A0	SPUGNA ESD ROSA LISCIA 410X343X15 M	0.250	PZ
Codice	Descrizione	Qtà	UM																										
PE2046A0	ASSIEME SUPPORTO USB-RESET M	1	PZ																										
PE2046A1	ASSIEME SUPPORTO USB-RESET M	1	PZ																										
PE2046A2	ASSIEME SUPPORTO USB-RESET M	1	PZ																										
VI1220A1	VITE AUTOFILETTA NTE 4.2X11 TCS+ MARUTE	2	PZ																										
VM2147A0	SPUGNA ESD ROSA LISCIA 410X343X15 M	0.250	PZ																										
PE2042A	ASSIEME CRUSCOTTO COMANDI MM ONE		KPE2042A	KIT CONTROLLO COMANDI MIND.MAPS ONE	<table border="1"> <thead> <tr> <th>Codice</th> <th>Descrizione</th> <th>Qtà</th> <th>UM</th> </tr> </thead> <tbody> <tr> <td>PE2042A0</td> <td>ASSIEME CRUSCOTTO COMANDI MM ONE</td> <td>1</td> <td>PZ</td> </tr> <tr> <td>PE2042A1</td> <td>ASSIEME CRUSCOTTO COMANDI MM ONE</td> <td>1</td> <td>PZ</td> </tr> <tr> <td>PE2042A2</td> <td>ASSIEME CRUSCOTTO COMANDI MM ONE</td> <td>1</td> <td>PZ</td> </tr> <tr> <td>VI2000A0</td> <td>VITE M4X22 TCB+ INOX</td> <td>4</td> <td>PZ</td> </tr> <tr> <td>VM2147A0</td> <td>SPUGNA ESD ROSA LISCIA 410X343X15 M</td> <td>1</td> <td>PZ</td> </tr> </tbody> </table>	Codice	Descrizione	Qtà	UM	PE2042A0	ASSIEME CRUSCOTTO COMANDI MM ONE	1	PZ	PE2042A1	ASSIEME CRUSCOTTO COMANDI MM ONE	1	PZ	PE2042A2	ASSIEME CRUSCOTTO COMANDI MM ONE	1	PZ	VI2000A0	VITE M4X22 TCB+ INOX	4	PZ	VM2147A0	SPUGNA ESD ROSA LISCIA 410X343X15 M	1	PZ
Codice	Descrizione	Qtà	UM																										
PE2042A0	ASSIEME CRUSCOTTO COMANDI MM ONE	1	PZ																										
PE2042A1	ASSIEME CRUSCOTTO COMANDI MM ONE	1	PZ																										
PE2042A2	ASSIEME CRUSCOTTO COMANDI MM ONE	1	PZ																										
VI2000A0	VITE M4X22 TCB+ INOX	4	PZ																										
VM2147A0	SPUGNA ESD ROSA LISCIA 410X343X15 M	1	PZ																										

ASM2911A/0.D02 - Camera di cottura



FRONTE



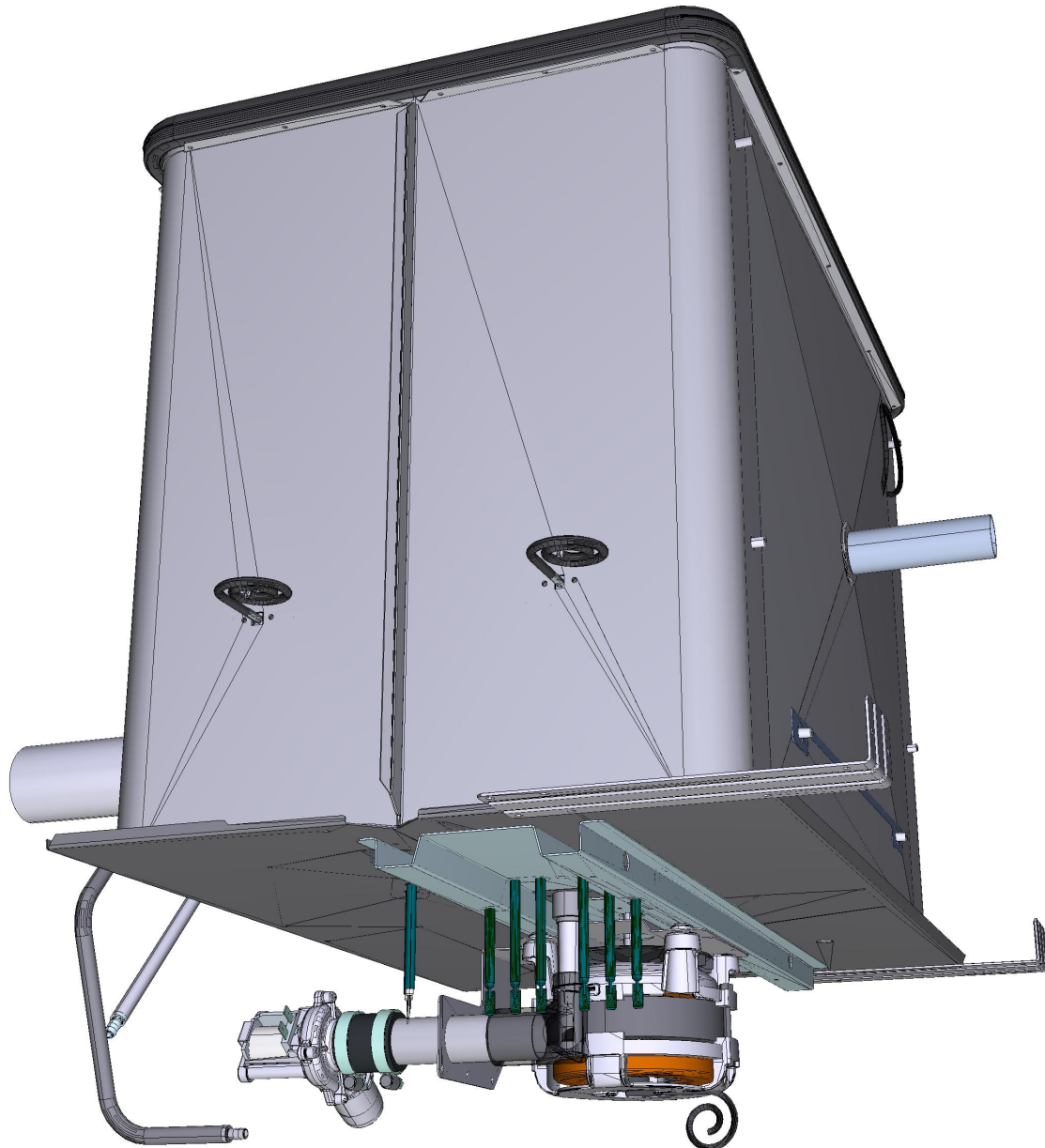

**ASM2911A/0.D02 - Camera di cottura**



**RETRO**



COMPONENTE			RICAMBIO																										
Codice	Descrizione	Immagine	Codice	Descrizione	Lista componenti																								
RS1215A	RESISTENZA FRENATA 147W 105V 1 SPIRA		KRS1215A	KIT RESISTENZA FRENATA 147W	<table border="1"> <thead> <tr> <th>Codice</th> <th>Descrizione</th> <th>Qtà</th> <th>UM</th> </tr> </thead> <tbody> <tr> <td>GN1326A1</td> <td>GUARNIZIONE RESISTENZA 71X19 G6.25</td> <td>1</td> <td>PZ</td> </tr> <tr> <td>RS1215A1</td> <td>RESISTENZA FRENATA 147W 105V 1 SPIRA</td> <td>1</td> <td>PZ</td> </tr> <tr> <td>SL1045A0</td> <td>SILICONE ANTRACITE S53 80 ML</td> <td>1</td> <td>PZ</td> </tr> <tr> <td>VI1220A1</td> <td>VITE AUTOFILETTA NTE 4.2X11 TCS+ MARUTE</td> <td>2</td> <td>PZ</td> </tr> <tr> <td>VM2147A0</td> <td>SPUGNA ESD ROSA LISCIA 410X343X15 M</td> <td>1</td> <td>PZ</td> </tr> </tbody> </table>	Codice	Descrizione	Qtà	UM	GN1326A1	GUARNIZIONE RESISTENZA 71X19 G6.25	1	PZ	RS1215A1	RESISTENZA FRENATA 147W 105V 1 SPIRA	1	PZ	SL1045A0	SILICONE ANTRACITE S53 80 ML	1	PZ	VI1220A1	VITE AUTOFILETTA NTE 4.2X11 TCS+ MARUTE	2	PZ	VM2147A0	SPUGNA ESD ROSA LISCIA 410X343X15 M	1	PZ
Codice	Descrizione	Qtà	UM																										
GN1326A1	GUARNIZIONE RESISTENZA 71X19 G6.25	1	PZ																										
RS1215A1	RESISTENZA FRENATA 147W 105V 1 SPIRA	1	PZ																										
SL1045A0	SILICONE ANTRACITE S53 80 ML	1	PZ																										
VI1220A1	VITE AUTOFILETTA NTE 4.2X11 TCS+ MARUTE	2	PZ																										
VM2147A0	SPUGNA ESD ROSA LISCIA 410X343X15 M	1	PZ																										
GN1326A	GUARNIZIONE RESISTENZA 71X19 G6.25		KRS1261A	KIT RESISTENZA FRENATA 122W	<table border="1"> <thead> <tr> <th>Codice</th> <th>Descrizione</th> <th>Qtà</th> <th>UM</th> </tr> </thead> <tbody> <tr> <td>GN1326A1</td> <td>GUARNIZIONE RESISTENZA 71X19 G6.25</td> <td>1</td> <td>PZ</td> </tr> <tr> <td>RS1261A0</td> <td>RESISTENZA MOTORE BAKERLUX\CH EFLUX</td> <td>1</td> <td>PZ</td> </tr> <tr> <td>SL1045A0</td> <td>SILICONE ANTRACITE S53 80 ML</td> <td>1</td> <td>PZ</td> </tr> <tr> <td>VI1220A1</td> <td>VITE AUTOFILETTA NTE 4.2X11 TCS+ MARUTE</td> <td>2</td> <td>PZ</td> </tr> <tr> <td>VM2147A0</td> <td>SPUGNA ESD ROSA LISCIA 410X343X15 M</td> <td>1</td> <td>PZ</td> </tr> </tbody> </table>	Codice	Descrizione	Qtà	UM	GN1326A1	GUARNIZIONE RESISTENZA 71X19 G6.25	1	PZ	RS1261A0	RESISTENZA MOTORE BAKERLUX\CH EFLUX	1	PZ	SL1045A0	SILICONE ANTRACITE S53 80 ML	1	PZ	VI1220A1	VITE AUTOFILETTA NTE 4.2X11 TCS+ MARUTE	2	PZ	VM2147A0	SPUGNA ESD ROSA LISCIA 410X343X15 M	1	PZ
Codice	Descrizione	Qtà	UM																										
GN1326A1	GUARNIZIONE RESISTENZA 71X19 G6.25	1	PZ																										
RS1261A0	RESISTENZA MOTORE BAKERLUX\CH EFLUX	1	PZ																										
SL1045A0	SILICONE ANTRACITE S53 80 ML	1	PZ																										
VI1220A1	VITE AUTOFILETTA NTE 4.2X11 TCS+ MARUTE	2	PZ																										
VM2147A0	SPUGNA ESD ROSA LISCIA 410X343X15 M	1	PZ																										
			KRS1215A	KIT RESISTENZA FRENATA 147W	<table border="1"> <thead> <tr> <th>Codice</th> <th>Descrizione</th> <th>Qtà</th> <th>UM</th> </tr> </thead> <tbody> <tr> <td>GN1326A1</td> <td>GUARNIZIONE RESISTENZA 71X19 G6.25</td> <td>1</td> <td>PZ</td> </tr> <tr> <td>RS1215A1</td> <td>RESISTENZA FRENATA 147W 105V 1 SPIRA</td> <td>1</td> <td>PZ</td> </tr> <tr> <td>SL1045A0</td> <td>SILICONE ANTRACITE S53 80 ML</td> <td>1</td> <td>PZ</td> </tr> <tr> <td>VI1220A1</td> <td>VITE AUTOFILETTA NTE 4.2X11 TCS+ MARUTE</td> <td>2</td> <td>PZ</td> </tr> <tr> <td>VM2147A0</td> <td>SPUGNA ESD ROSA LISCIA 410X343X15 M</td> <td>1</td> <td>PZ</td> </tr> </tbody> </table>	Codice	Descrizione	Qtà	UM	GN1326A1	GUARNIZIONE RESISTENZA 71X19 G6.25	1	PZ	RS1215A1	RESISTENZA FRENATA 147W 105V 1 SPIRA	1	PZ	SL1045A0	SILICONE ANTRACITE S53 80 ML	1	PZ	VI1220A1	VITE AUTOFILETTA NTE 4.2X11 TCS+ MARUTE	2	PZ	VM2147A0	SPUGNA ESD ROSA LISCIA 410X343X15 M	1	PZ
Codice	Descrizione	Qtà	UM																										
GN1326A1	GUARNIZIONE RESISTENZA 71X19 G6.25	1	PZ																										
RS1215A1	RESISTENZA FRENATA 147W 105V 1 SPIRA	1	PZ																										
SL1045A0	SILICONE ANTRACITE S53 80 ML	1	PZ																										
VI1220A1	VITE AUTOFILETTA NTE 4.2X11 TCS+ MARUTE	2	PZ																										
VM2147A0	SPUGNA ESD ROSA LISCIA 410X343X15 M	1	PZ																										

COMPONENTE			RICAMBIO																																		
Codice	Descrizione	Immagine	Codice	Descrizione	Lista componenti																																
GN1326A	GUARNIZIONE RESISTENZA 71X19 G6.25		KRS1095A	KIT RESISTENZA 1.2KW	<table border="1"> <thead> <tr> <th>Codice</th> <th>Descrizione</th> <th>Qtà</th> <th>UM</th> </tr> </thead> <tbody> <tr> <td>GN1326A1</td> <td>GUARNIZIONE RESISTENZA 71X19 G6.25</td> <td>1</td> <td>PZ</td> </tr> <tr> <td>IP1385A0</td> <td>IMBALLO POLISTIROLO ANGOLARE 110X80X2000</td> <td>1.200</td> <td>PZ</td> </tr> <tr> <td>IP1385A1</td> <td>IMB POL ANGOLARE 110X80X2000 D30</td> <td>0.500</td> <td>M</td> </tr> <tr> <td>RS1095A1</td> <td>RESISTENZA PIANA 1200W 230V</td> <td>1</td> <td>PZ</td> </tr> <tr> <td>SL1045A0</td> <td>SILICONE ANTRACITE S53 80 ML</td> <td>1</td> <td>PZ</td> </tr> <tr> <td>VI1220A1</td> <td>VITE AUTOFILETTA NTE 4.2X11 TCS+ MARUTE</td> <td>2</td> <td>PZ</td> </tr> <tr> <td>VM1059A1</td> <td>FILM TERMORETRA IBILE H800</td> <td>1.200</td> <td>M</td> </tr> </tbody> </table>	Codice	Descrizione	Qtà	UM	GN1326A1	GUARNIZIONE RESISTENZA 71X19 G6.25	1	PZ	IP1385A0	IMBALLO POLISTIROLO ANGOLARE 110X80X2000	1.200	PZ	IP1385A1	IMB POL ANGOLARE 110X80X2000 D30	0.500	M	RS1095A1	RESISTENZA PIANA 1200W 230V	1	PZ	SL1045A0	SILICONE ANTRACITE S53 80 ML	1	PZ	VI1220A1	VITE AUTOFILETTA NTE 4.2X11 TCS+ MARUTE	2	PZ	VM1059A1	FILM TERMORETRA IBILE H800	1.200	M
			Codice	Descrizione	Qtà	UM																															
			GN1326A1	GUARNIZIONE RESISTENZA 71X19 G6.25	1	PZ																															
IP1385A0	IMBALLO POLISTIROLO ANGOLARE 110X80X2000	1.200	PZ																																		
IP1385A1	IMB POL ANGOLARE 110X80X2000 D30	0.500	M																																		
RS1095A1	RESISTENZA PIANA 1200W 230V	1	PZ																																		
SL1045A0	SILICONE ANTRACITE S53 80 ML	1	PZ																																		
VI1220A1	VITE AUTOFILETTA NTE 4.2X11 TCS+ MARUTE	2	PZ																																		
VM1059A1	FILM TERMORETRA IBILE H800	1.200	M																																		
KRS1012A	KIT RESISTENZA 1365W 120V	<table border="1"> <thead> <tr> <th>Codice</th> <th>Descrizione</th> <th>Qtà</th> <th>UM</th> </tr> </thead> <tbody> <tr> <td>GN1326A1</td> <td>GUARNIZIONE RESISTENZA 71X19 G6.25</td> <td>1</td> <td>PZ</td> </tr> <tr> <td>RS1012A0</td> <td>RESISTENZA CIRCOLARE 1365W 120V</td> <td>1</td> <td>PZ</td> </tr> <tr> <td>VI1220A1</td> <td>VITE AUTOFILETTA NTE 4.2X11 TCS+ MARUTE</td> <td>5</td> <td>PZ</td> </tr> <tr> <td>VM1794A0</td> <td>FASCETTA 250X4.8 PA66 NERA</td> <td>2</td> <td>PZ</td> </tr> <tr> <td>VM2103A0</td> <td>PIASTRINA FERMAFASCE TTA</td> <td>2</td> <td>PZ</td> </tr> </tbody> </table>	Codice	Descrizione	Qtà	UM	GN1326A1	GUARNIZIONE RESISTENZA 71X19 G6.25	1	PZ	RS1012A0	RESISTENZA CIRCOLARE 1365W 120V	1	PZ	VI1220A1	VITE AUTOFILETTA NTE 4.2X11 TCS+ MARUTE	5	PZ	VM1794A0	FASCETTA 250X4.8 PA66 NERA	2	PZ	VM2103A0	PIASTRINA FERMAFASCE TTA	2	PZ											
Codice	Descrizione	Qtà	UM																																		
GN1326A1	GUARNIZIONE RESISTENZA 71X19 G6.25	1	PZ																																		
RS1012A0	RESISTENZA CIRCOLARE 1365W 120V	1	PZ																																		
VI1220A1	VITE AUTOFILETTA NTE 4.2X11 TCS+ MARUTE	5	PZ																																		
VM1794A0	FASCETTA 250X4.8 PA66 NERA	2	PZ																																		
VM2103A0	PIASTRINA FERMAFASCE TTA	2	PZ																																		
KRS1011A	KIT RESISTENZA ROBERTA/LISA	<table border="1"> <thead> <tr> <th>Codice</th> <th>Descrizione</th> <th>Qtà</th> <th>UM</th> </tr> </thead> <tbody> <tr> <td>GN1326A1</td> <td>GUARNIZIONE RESISTENZA 71X19 G6.25</td> <td>1</td> <td>PZ</td> </tr> <tr> <td>RS1011A0</td> <td>RESISTENZA CIRCOLARE 2560W 220-230</td> <td>1</td> <td>PZ</td> </tr> <tr> <td>SL1045A0</td> <td>SILICONE ANTRACITE S53 80 ML</td> <td>1</td> <td>PZ</td> </tr> </tbody> </table>	Codice	Descrizione	Qtà	UM	GN1326A1	GUARNIZIONE RESISTENZA 71X19 G6.25	1	PZ	RS1011A0	RESISTENZA CIRCOLARE 2560W 220-230	1	PZ	SL1045A0	SILICONE ANTRACITE S53 80 ML	1	PZ																			
Codice	Descrizione	Qtà	UM																																		
GN1326A1	GUARNIZIONE RESISTENZA 71X19 G6.25	1	PZ																																		
RS1011A0	RESISTENZA CIRCOLARE 2560W 220-230	1	PZ																																		
SL1045A0	SILICONE ANTRACITE S53 80 ML	1	PZ																																		



COMPONENTE			RICAMBIO																							
Codice	Descrizione	Immagine	Codice	Descrizione	Lista componenti																					
GN1326A	GUARNIZIONE RESISTENZA 71X19 G6.25		KRS1011A	KIT RESISTENZA ROBERTA/LISA	<table border="1"> <thead> <tr> <th>Codice</th> <th>Descrizione</th> <th>Qtà</th> <th>UM</th> </tr> </thead> <tbody> <tr> <td>VI1220A1</td> <td>VITE AUTOFILETTA NTE 4.2X11 TCS+ MARUTE</td> <td>5</td> <td>PZ</td> </tr> <tr> <td>VM1794A0</td> <td>FASCETTA 250X4.8 PA66 NERA</td> <td>2</td> <td>PZ</td> </tr> <tr> <td>VM2103A0</td> <td>PIASTRINA FERMAFASCE TTA</td> <td>2</td> <td>PZ</td> </tr> </tbody> </table>	Codice	Descrizione	Qtà	UM	VI1220A1	VITE AUTOFILETTA NTE 4.2X11 TCS+ MARUTE	5	PZ	VM1794A0	FASCETTA 250X4.8 PA66 NERA	2	PZ	VM2103A0	PIASTRINA FERMAFASCE TTA	2	PZ					
			Codice	Descrizione	Qtà	UM																				
			VI1220A1	VITE AUTOFILETTA NTE 4.2X11 TCS+ MARUTE	5	PZ																				
			VM1794A0	FASCETTA 250X4.8 PA66 NERA	2	PZ																				
VM2103A0	PIASTRINA FERMAFASCE TTA	2	PZ																							
KRS0090A	KIT RESISTENZA 1.26KW	<table border="1"> <thead> <tr> <th>Codice</th> <th>Descrizione</th> <th>Qtà</th> <th>UM</th> </tr> </thead> <tbody> <tr> <td>GN1326A1</td> <td>GUARNIZIONE RESISTENZA 71X19 G6.25</td> <td>1</td> <td>PZ</td> </tr> <tr> <td>RS0090A0</td> <td>RESISTENZA CIRCOLARE 1260W 220-230</td> <td>1</td> <td>PZ</td> </tr> <tr> <td>VI1220A1</td> <td>VITE AUTOFILETTA NTE 4.2X11 TCS+ MARUTE</td> <td>3</td> <td>PZ</td> </tr> <tr> <td>VM1794A0</td> <td>FASCETTA 250X4.8 PA66 NERA</td> <td>2</td> <td>PZ</td> </tr> <tr> <td>VM2103A0</td> <td>PIASTRINA FERMAFASCE TTA</td> <td>2</td> <td>PZ</td> </tr> </tbody> </table>	Codice	Descrizione	Qtà	UM	GN1326A1	GUARNIZIONE RESISTENZA 71X19 G6.25	1	PZ	RS0090A0	RESISTENZA CIRCOLARE 1260W 220-230	1	PZ	VI1220A1	VITE AUTOFILETTA NTE 4.2X11 TCS+ MARUTE	3	PZ	VM1794A0	FASCETTA 250X4.8 PA66 NERA	2	PZ	VM2103A0	PIASTRINA FERMAFASCE TTA	2	PZ
Codice	Descrizione	Qtà	UM																							
GN1326A1	GUARNIZIONE RESISTENZA 71X19 G6.25	1	PZ																							
RS0090A0	RESISTENZA CIRCOLARE 1260W 220-230	1	PZ																							
VI1220A1	VITE AUTOFILETTA NTE 4.2X11 TCS+ MARUTE	3	PZ																							
VM1794A0	FASCETTA 250X4.8 PA66 NERA	2	PZ																							
VM2103A0	PIASTRINA FERMAFASCE TTA	2	PZ																							
KRS0050A	KIT RESISTENZA 0.5KW	<table border="1"> <thead> <tr> <th>Codice</th> <th>Descrizione</th> <th>Qtà</th> <th>UM</th> </tr> </thead> <tbody> <tr> <td>GN1326A1</td> <td>GUARNIZIONE RESISTENZA 71X19 G6.25</td> <td>1</td> <td>PZ</td> </tr> <tr> <td>IP1075A1</td> <td>IMB POL 70X150X765 D=10 CON PRETAGLIO</td> <td>1</td> <td>PZ</td> </tr> <tr> <td>IP1080A1</td> <td>IMB POL 280X255X10 D=10</td> <td>1</td> <td>PZ</td> </tr> <tr> <td>RS0050A0</td> <td>RESISTENZA PIANA 500W 220-230V</td> <td>1</td> <td>PZ</td> </tr> <tr> <td>VI1220A1</td> <td>VITE AUTOFILETTA NTE 4.2X11 TCS+ MARUTE</td> <td>2</td> <td>PZ</td> </tr> </tbody> </table>	Codice	Descrizione	Qtà	UM	GN1326A1	GUARNIZIONE RESISTENZA 71X19 G6.25	1	PZ	IP1075A1	IMB POL 70X150X765 D=10 CON PRETAGLIO	1	PZ	IP1080A1	IMB POL 280X255X10 D=10	1	PZ	RS0050A0	RESISTENZA PIANA 500W 220-230V	1	PZ	VI1220A1	VITE AUTOFILETTA NTE 4.2X11 TCS+ MARUTE	2	PZ
Codice	Descrizione	Qtà	UM																							
GN1326A1	GUARNIZIONE RESISTENZA 71X19 G6.25	1	PZ																							
IP1075A1	IMB POL 70X150X765 D=10 CON PRETAGLIO	1	PZ																							
IP1080A1	IMB POL 280X255X10 D=10	1	PZ																							
RS0050A0	RESISTENZA PIANA 500W 220-230V	1	PZ																							
VI1220A1	VITE AUTOFILETTA NTE 4.2X11 TCS+ MARUTE	2	PZ																							
KRS0011A	KIT RESISTENZA 1.465KW RS0011A	<table border="1"> <thead> <tr> <th>Codice</th> <th>Descrizione</th> <th>Qtà</th> <th>UM</th> </tr> </thead> <tbody> <tr> <td>GN1326A1</td> <td>GUARNIZIONE RESISTENZA 71X19 G6.25</td> <td>1</td> <td>PZ</td> </tr> </tbody> </table>	Codice	Descrizione	Qtà	UM	GN1326A1	GUARNIZIONE RESISTENZA 71X19 G6.25	1	PZ																
Codice	Descrizione	Qtà	UM																							
GN1326A1	GUARNIZIONE RESISTENZA 71X19 G6.25	1	PZ																							

COMPONENTE			RICAMBIO																										
Codice	Descrizione	Immagine	Codice	Descrizione	Lista componenti																								
GN1326A	GUARNIZIONE RESISTENZA 71X19 G6.25		KRS0011A	KIT RESISTENZA 1.465KW RS0011A	<table border="1"> <thead> <tr> <th>Codice</th> <th>Descrizione</th> <th>Qtà</th> <th>UM</th> </tr> </thead> <tbody> <tr> <td>RS0011A0</td> <td>RESISTENZA CIRCOLARE 1465W 220-230</td> <td>1</td> <td>PZ</td> </tr> <tr> <td>VI1220A1</td> <td>VITE AUTOFILETTA NTE 4.2X11 TCS+ MARUTE</td> <td>3</td> <td>PZ</td> </tr> <tr> <td>VM1794A0</td> <td>FASCETTA 250X4.8 PA66 NERA</td> <td>2</td> <td>PZ</td> </tr> <tr> <td>VM2103A0</td> <td>PIASTRINA FERMAFASCE TTA</td> <td>2</td> <td>PZ</td> </tr> </tbody> </table>	Codice	Descrizione	Qtà	UM	RS0011A0	RESISTENZA CIRCOLARE 1465W 220-230	1	PZ	VI1220A1	VITE AUTOFILETTA NTE 4.2X11 TCS+ MARUTE	3	PZ	VM1794A0	FASCETTA 250X4.8 PA66 NERA	2	PZ	VM2103A0	PIASTRINA FERMAFASCE TTA	2	PZ				
			Codice	Descrizione	Qtà	UM																							
			RS0011A0	RESISTENZA CIRCOLARE 1465W 220-230	1	PZ																							
VI1220A1	VITE AUTOFILETTA NTE 4.2X11 TCS+ MARUTE	3	PZ																										
VM1794A0	FASCETTA 250X4.8 PA66 NERA	2	PZ																										
VM2103A0	PIASTRINA FERMAFASCE TTA	2	PZ																										
KRS0010A	KIT RESISTENZA RS0010A	<table border="1"> <thead> <tr> <th>Codice</th> <th>Descrizione</th> <th>Qtà</th> <th>UM</th> </tr> </thead> <tbody> <tr> <td>GN1326A1</td> <td>GUARNIZIONE RESISTENZA 71X19 G6.25</td> <td>1</td> <td>PZ</td> </tr> <tr> <td>IP1075A1</td> <td>IMB POL 70X150X765 D=10 CON PRETAGLIO</td> <td>1</td> <td>PZ</td> </tr> <tr> <td>IP1080A1</td> <td>IMB POL 280X255X10 D=10</td> <td>5</td> <td>PZ</td> </tr> <tr> <td>RS0010A0</td> <td>RESISTENZA CIRCOLARE 2560W 220-230</td> <td>1</td> <td>PZ</td> </tr> <tr> <td>VI1220A1</td> <td>VITE AUTOFILETTA NTE 4.2X11 TCS+ MARUTE</td> <td>3</td> <td>PZ</td> </tr> </tbody> </table>	Codice	Descrizione	Qtà	UM	GN1326A1	GUARNIZIONE RESISTENZA 71X19 G6.25	1	PZ	IP1075A1	IMB POL 70X150X765 D=10 CON PRETAGLIO	1	PZ	IP1080A1	IMB POL 280X255X10 D=10	5	PZ	RS0010A0	RESISTENZA CIRCOLARE 2560W 220-230	1	PZ	VI1220A1	VITE AUTOFILETTA NTE 4.2X11 TCS+ MARUTE	3	PZ			
Codice	Descrizione	Qtà	UM																										
GN1326A1	GUARNIZIONE RESISTENZA 71X19 G6.25	1	PZ																										
IP1075A1	IMB POL 70X150X765 D=10 CON PRETAGLIO	1	PZ																										
IP1080A1	IMB POL 280X255X10 D=10	5	PZ																										
RS0010A0	RESISTENZA CIRCOLARE 2560W 220-230	1	PZ																										
VI1220A1	VITE AUTOFILETTA NTE 4.2X11 TCS+ MARUTE	3	PZ																										
KGN1326A	KIT 5 PZ GUARNIZIONE RESISTENZA	<table border="1"> <thead> <tr> <th>Codice</th> <th>Descrizione</th> <th>Qtà</th> <th>UM</th> </tr> </thead> <tbody> <tr> <td>GN1326A1</td> <td>GUARNIZIONE RESISTENZA 71X19 G6.25</td> <td>5</td> <td>PZ</td> </tr> </tbody> </table>	Codice	Descrizione	Qtà	UM	GN1326A1	GUARNIZIONE RESISTENZA 71X19 G6.25	5	PZ																			
Codice	Descrizione	Qtà	UM																										
GN1326A1	GUARNIZIONE RESISTENZA 71X19 G6.25	5	PZ																										
GN1285A	GUARNIZIONE SONDA DI TEMPERATURA NTC		KTR1106A	GNT1326A1 KIT SONDA TEMP. CAMERA L2000 S.5-5	<table border="1"> <thead> <tr> <th>Codice</th> <th>Descrizione</th> <th>Qtà</th> <th>UM</th> </tr> </thead> <tbody> <tr> <td>GN1285A0</td> <td>GUARNIZIONE SONDA DI TEMPERATUR A NTC</td> <td>1</td> <td>PZ</td> </tr> <tr> <td>SL1045A0</td> <td>SILICONE ANTRACITE S53 80 ML</td> <td>1</td> <td>PZ</td> </tr> <tr> <td>TR1106A3</td> <td>SONDA TEMPERATUR A PT100 L2000</td> <td>1</td> <td>PZ</td> </tr> <tr> <td>VI1220A1</td> <td>VITE AUTOFILETTA NTE 4.2X11 TCS+ MARUTE</td> <td>2</td> <td>PZ</td> </tr> <tr> <td>VM1465A0</td> <td>COPERCHIO SONDA TEMPERATUR A CHEFTOP</td> <td>1</td> <td>PZ</td> </tr> </tbody> </table>	Codice	Descrizione	Qtà	UM	GN1285A0	GUARNIZIONE SONDA DI TEMPERATUR A NTC	1	PZ	SL1045A0	SILICONE ANTRACITE S53 80 ML	1	PZ	TR1106A3	SONDA TEMPERATUR A PT100 L2000	1	PZ	VI1220A1	VITE AUTOFILETTA NTE 4.2X11 TCS+ MARUTE	2	PZ	VM1465A0	COPERCHIO SONDA TEMPERATUR A CHEFTOP	1	PZ
			Codice	Descrizione	Qtà	UM																							
			GN1285A0	GUARNIZIONE SONDA DI TEMPERATUR A NTC	1	PZ																							
			SL1045A0	SILICONE ANTRACITE S53 80 ML	1	PZ																							
			TR1106A3	SONDA TEMPERATUR A PT100 L2000	1	PZ																							
VI1220A1	VITE AUTOFILETTA NTE 4.2X11 TCS+ MARUTE	2	PZ																										
VM1465A0	COPERCHIO SONDA TEMPERATUR A CHEFTOP	1	PZ																										



COMPONENTE			RICAMBIO																																		
Codice	Descrizione	Immagine	Codice	Descrizione	Lista componenti																																
GN1285A	GUARNIZIONE SONDA DI TEMPERATURA NTC		KTR1105A	KIT SONDA TEMPERATURA PT100 L1000	<table border="1"> <thead> <tr> <th>Codice</th> <th>Descrizione</th> <th>Qtà</th> <th>UM</th> </tr> </thead> <tbody> <tr> <td>GN1120A0</td> <td>GUARNIZIONE SONDA DI TEMPERATUR A NTC</td> <td>1</td> <td>PZ</td> </tr> <tr> <td>GN1285A0</td> <td>GUARNIZIONE SONDA DI TEMPERATUR A NTC</td> <td>1</td> <td>PZ</td> </tr> <tr> <td>SL1045A0</td> <td>SILICONE ANTRACITE S53 80 ML</td> <td>1</td> <td>PZ</td> </tr> <tr> <td>TR1105A3</td> <td>SONDA TEMPERATUR A PT100 L1000</td> <td>1</td> <td>PZ</td> </tr> <tr> <td>TR1105A4</td> <td>SONDA TEMPERATUR A PT100 L1000</td> <td>1</td> <td>PZ</td> </tr> <tr> <td>VI1220A1</td> <td>VITE AUTOFILETTA NTE 4.2X11 TCS+ MARUTE</td> <td>2</td> <td>PZ</td> </tr> <tr> <td>VM1465A0</td> <td>COPERCHIO SONDA TEMPERATUR A CHEFTOP</td> <td>1</td> <td>PZ</td> </tr> </tbody> </table>	Codice	Descrizione	Qtà	UM	GN1120A0	GUARNIZIONE SONDA DI TEMPERATUR A NTC	1	PZ	GN1285A0	GUARNIZIONE SONDA DI TEMPERATUR A NTC	1	PZ	SL1045A0	SILICONE ANTRACITE S53 80 ML	1	PZ	TR1105A3	SONDA TEMPERATUR A PT100 L1000	1	PZ	TR1105A4	SONDA TEMPERATUR A PT100 L1000	1	PZ	VI1220A1	VITE AUTOFILETTA NTE 4.2X11 TCS+ MARUTE	2	PZ	VM1465A0	COPERCHIO SONDA TEMPERATUR A CHEFTOP	1	PZ
			Codice	Descrizione	Qtà	UM																															
GN1120A0	GUARNIZIONE SONDA DI TEMPERATUR A NTC	1	PZ																																		
GN1285A0	GUARNIZIONE SONDA DI TEMPERATUR A NTC	1	PZ																																		
SL1045A0	SILICONE ANTRACITE S53 80 ML	1	PZ																																		
TR1105A3	SONDA TEMPERATUR A PT100 L1000	1	PZ																																		
TR1105A4	SONDA TEMPERATUR A PT100 L1000	1	PZ																																		
VI1220A1	VITE AUTOFILETTA NTE 4.2X11 TCS+ MARUTE	2	PZ																																		
VM1465A0	COPERCHIO SONDA TEMPERATUR A CHEFTOP	1	PZ																																		
KTR1096A	KIT SONDA TEMPERATURA NTC 150 L=1500	<table border="1"> <thead> <tr> <th>Codice</th> <th>Descrizione</th> <th>Qtà</th> <th>UM</th> </tr> </thead> <tbody> <tr> <td>GN1120A0</td> <td>GUARNIZIONE SONDA DI TEMPERATUR A NTC</td> <td>1</td> <td>PZ</td> </tr> <tr> <td>GN1285A0</td> <td>GUARNIZIONE SONDA DI TEMPERATUR A NTC</td> <td>2</td> <td>PZ</td> </tr> <tr> <td>SL1045A0</td> <td>SILICONE ANTRACITE S53 80 ML</td> <td>1</td> <td>PZ</td> </tr> <tr> <td>TR1096A0</td> <td>SONDA TEMPERATUR A NTC 150 L=1500</td> <td>1</td> <td>PZ</td> </tr> <tr> <td>VI1220A1</td> <td>VITE AUTOFILETTA NTE 4.2X11 TCS+ MARUTE</td> <td>2</td> <td>PZ</td> </tr> <tr> <td>VM1465A0</td> <td>COPERCHIO SONDA TEMPERATUR A CHEFTOP</td> <td>1</td> <td>PZ</td> </tr> </tbody> </table>	Codice	Descrizione	Qtà	UM	GN1120A0	GUARNIZIONE SONDA DI TEMPERATUR A NTC	1	PZ	GN1285A0	GUARNIZIONE SONDA DI TEMPERATUR A NTC	2	PZ	SL1045A0	SILICONE ANTRACITE S53 80 ML	1	PZ	TR1096A0	SONDA TEMPERATUR A NTC 150 L=1500	1	PZ	VI1220A1	VITE AUTOFILETTA NTE 4.2X11 TCS+ MARUTE	2	PZ	VM1465A0	COPERCHIO SONDA TEMPERATUR A CHEFTOP	1	PZ							
Codice	Descrizione	Qtà	UM																																		
GN1120A0	GUARNIZIONE SONDA DI TEMPERATUR A NTC	1	PZ																																		
GN1285A0	GUARNIZIONE SONDA DI TEMPERATUR A NTC	2	PZ																																		
SL1045A0	SILICONE ANTRACITE S53 80 ML	1	PZ																																		
TR1096A0	SONDA TEMPERATUR A NTC 150 L=1500	1	PZ																																		
VI1220A1	VITE AUTOFILETTA NTE 4.2X11 TCS+ MARUTE	2	PZ																																		
VM1465A0	COPERCHIO SONDA TEMPERATUR A CHEFTOP	1	PZ																																		





COMPONENTE			RICAMBIO																														
Codice	Descrizione	Immagine	Codice	Descrizione	Lista componenti																												
GN1285A	GUARNIZIONE SONDA DI TEMPERATURA NTC		KTR1095A	KIT SONDA TEMPERATURA NTC 150 L=1050	<table border="1"> <thead> <tr> <th>Codice</th> <th>Descrizione</th> <th>Qtà</th> <th>UM</th> </tr> </thead> <tbody> <tr> <td>GN1120A0</td> <td>GUARNIZIONE SONDA DI TEMPERATUR A NTC</td> <td>1</td> <td>PZ</td> </tr> <tr> <td>GN1285A0</td> <td>GUARNIZIONE SONDA DI TEMPERATUR A NTC</td> <td>1</td> <td>PZ</td> </tr> <tr> <td>SL1045A0</td> <td>SILICONE ANTRACITE S53 80 ML</td> <td>1</td> <td>PZ</td> </tr> <tr> <td>TR1095A0</td> <td>SONDA TEMPERATUR A NTC 150 L=1050</td> <td>1</td> <td>PZ</td> </tr> <tr> <td>VI1220A1</td> <td>VITE AUTOFILETTA NTE 4.2X11 TCS+ MARUTE</td> <td>2</td> <td>PZ</td> </tr> <tr> <td>VM1465A0</td> <td>COPERCHIO SONDA TEMPERATUR A CHEFTOP</td> <td>1</td> <td>PZ</td> </tr> </tbody> </table>	Codice	Descrizione	Qtà	UM	GN1120A0	GUARNIZIONE SONDA DI TEMPERATUR A NTC	1	PZ	GN1285A0	GUARNIZIONE SONDA DI TEMPERATUR A NTC	1	PZ	SL1045A0	SILICONE ANTRACITE S53 80 ML	1	PZ	TR1095A0	SONDA TEMPERATUR A NTC 150 L=1050	1	PZ	VI1220A1	VITE AUTOFILETTA NTE 4.2X11 TCS+ MARUTE	2	PZ	VM1465A0	COPERCHIO SONDA TEMPERATUR A CHEFTOP	1	PZ
			Codice	Descrizione	Qtà	UM																											
GN1120A0	GUARNIZIONE SONDA DI TEMPERATUR A NTC	1	PZ																														
GN1285A0	GUARNIZIONE SONDA DI TEMPERATUR A NTC	1	PZ																														
SL1045A0	SILICONE ANTRACITE S53 80 ML	1	PZ																														
TR1095A0	SONDA TEMPERATUR A NTC 150 L=1050	1	PZ																														
VI1220A1	VITE AUTOFILETTA NTE 4.2X11 TCS+ MARUTE	2	PZ																														
VM1465A0	COPERCHIO SONDA TEMPERATUR A CHEFTOP	1	PZ																														
KTR1002A	KIT SONDA TEMPERATURA UL PT100 L1000	<table border="1"> <thead> <tr> <th>Codice</th> <th>Descrizione</th> <th>Qtà</th> <th>UM</th> </tr> </thead> <tbody> <tr> <td>GN1285A0</td> <td>GUARNIZIONE SONDA DI TEMPERATUR A NTC</td> <td>2</td> <td>PZ</td> </tr> <tr> <td>SL1045A0</td> <td>SILICONE ANTRACITE S53 80 ML</td> <td>1</td> <td>PZ</td> </tr> <tr> <td>TR1002A0</td> <td>SONDA TEMPERATUR A UL PT100 L1000</td> <td>1</td> <td>PZ</td> </tr> <tr> <td>TR1002A1</td> <td>SONDA TEMPERATUR A UL PT100 L1000</td> <td>1</td> <td>PZ</td> </tr> <tr> <td>VI1220A1</td> <td>VITE AUTOFILETTA NTE 4.2X11 TCS+ MARUTE</td> <td>2</td> <td>PZ</td> </tr> <tr> <td>VM1465A0</td> <td>COPERCHIO SONDA TEMPERATUR A CHEFTOP</td> <td>1</td> <td>PZ</td> </tr> </tbody> </table>	Codice	Descrizione	Qtà	UM	GN1285A0	GUARNIZIONE SONDA DI TEMPERATUR A NTC	2	PZ	SL1045A0	SILICONE ANTRACITE S53 80 ML	1	PZ	TR1002A0	SONDA TEMPERATUR A UL PT100 L1000	1	PZ	TR1002A1	SONDA TEMPERATUR A UL PT100 L1000	1	PZ	VI1220A1	VITE AUTOFILETTA NTE 4.2X11 TCS+ MARUTE	2	PZ	VM1465A0	COPERCHIO SONDA TEMPERATUR A CHEFTOP	1	PZ			
Codice	Descrizione	Qtà	UM																														
GN1285A0	GUARNIZIONE SONDA DI TEMPERATUR A NTC	2	PZ																														
SL1045A0	SILICONE ANTRACITE S53 80 ML	1	PZ																														
TR1002A0	SONDA TEMPERATUR A UL PT100 L1000	1	PZ																														
TR1002A1	SONDA TEMPERATUR A UL PT100 L1000	1	PZ																														
VI1220A1	VITE AUTOFILETTA NTE 4.2X11 TCS+ MARUTE	2	PZ																														
VM1465A0	COPERCHIO SONDA TEMPERATUR A CHEFTOP	1	PZ																														



COMPONENTE			RICAMBIO																														
Codice	Descrizione	Immagine	Codice	Descrizione	Lista componenti																												
TR1106A	SONDA TEMPERATURA PT100 L2000		KTR1106B	KIT SONDA TEMP. CAMERA L2000 MIND.MAPS	<table border="1"> <thead> <tr> <th>Codice</th> <th>Descrizione</th> <th>Qtà</th> <th>UM</th> </tr> </thead> <tbody> <tr> <td>GN1285A0</td> <td>GUARNIZIONE SONDA DI TEMPERATUR A NTC</td> <td>1</td> <td>PZ</td> </tr> <tr> <td>SL1045A0</td> <td>SILICONE ANTRACITE S53 80 ML</td> <td>1</td> <td>PZ</td> </tr> <tr> <td>TR1106B0</td> <td>SONDA TEMPERATUR A PT100 L 200</td> <td>1</td> <td>PZ</td> </tr> <tr> <td>VI1220A1</td> <td>VITE AUTOFILETTA NTE 4.2X11 TCS+ MARUTE</td> <td>2</td> <td>PZ</td> </tr> <tr> <td>VM1464A0</td> <td>COPERCHIO SONDA TEMPERATUR A CT BT CON PA</td> <td>1</td> <td>PZ</td> </tr> <tr> <td>VM1465A0</td> <td>COPERCHIO SONDA TEMPERATUR A CHEFTOP</td> <td>1</td> <td>PZ</td> </tr> </tbody> </table>	Codice	Descrizione	Qtà	UM	GN1285A0	GUARNIZIONE SONDA DI TEMPERATUR A NTC	1	PZ	SL1045A0	SILICONE ANTRACITE S53 80 ML	1	PZ	TR1106B0	SONDA TEMPERATUR A PT100 L 200	1	PZ	VI1220A1	VITE AUTOFILETTA NTE 4.2X11 TCS+ MARUTE	2	PZ	VM1464A0	COPERCHIO SONDA TEMPERATUR A CT BT CON PA	1	PZ	VM1465A0	COPERCHIO SONDA TEMPERATUR A CHEFTOP	1	PZ
			Codice	Descrizione	Qtà	UM																											
GN1285A0	GUARNIZIONE SONDA DI TEMPERATUR A NTC	1	PZ																														
SL1045A0	SILICONE ANTRACITE S53 80 ML	1	PZ																														
TR1106B0	SONDA TEMPERATUR A PT100 L 200	1	PZ																														
VI1220A1	VITE AUTOFILETTA NTE 4.2X11 TCS+ MARUTE	2	PZ																														
VM1464A0	COPERCHIO SONDA TEMPERATUR A CT BT CON PA	1	PZ																														
VM1465A0	COPERCHIO SONDA TEMPERATUR A CHEFTOP	1	PZ																														
KTR1106A	KIT SONDA TEMP. CAMERA L2000 S.5-5	<table border="1"> <thead> <tr> <th>Codice</th> <th>Descrizione</th> <th>Qtà</th> <th>UM</th> </tr> </thead> <tbody> <tr> <td>GN1285A0</td> <td>GUARNIZIONE SONDA DI TEMPERATUR A NTC</td> <td>1</td> <td>PZ</td> </tr> <tr> <td>SL1045A0</td> <td>SILICONE ANTRACITE S53 80 ML</td> <td>1</td> <td>PZ</td> </tr> <tr> <td>TR1106A3</td> <td>SONDA TEMPERATUR A PT100 L2000</td> <td>1</td> <td>PZ</td> </tr> <tr> <td>VI1220A1</td> <td>VITE AUTOFILETTA NTE 4.2X11 TCS+ MARUTE</td> <td>2</td> <td>PZ</td> </tr> <tr> <td>VM1465A0</td> <td>COPERCHIO SONDA TEMPERATUR A CHEFTOP</td> <td>1</td> <td>PZ</td> </tr> </tbody> </table>	Codice	Descrizione	Qtà	UM	GN1285A0	GUARNIZIONE SONDA DI TEMPERATUR A NTC	1	PZ	SL1045A0	SILICONE ANTRACITE S53 80 ML	1	PZ	TR1106A3	SONDA TEMPERATUR A PT100 L2000	1	PZ	VI1220A1	VITE AUTOFILETTA NTE 4.2X11 TCS+ MARUTE	2	PZ	VM1465A0	COPERCHIO SONDA TEMPERATUR A CHEFTOP	1	PZ							
Codice	Descrizione	Qtà	UM																														
GN1285A0	GUARNIZIONE SONDA DI TEMPERATUR A NTC	1	PZ																														
SL1045A0	SILICONE ANTRACITE S53 80 ML	1	PZ																														
TR1106A3	SONDA TEMPERATUR A PT100 L2000	1	PZ																														
VI1220A1	VITE AUTOFILETTA NTE 4.2X11 TCS+ MARUTE	2	PZ																														
VM1465A0	COPERCHIO SONDA TEMPERATUR A CHEFTOP	1	PZ																														
VM1464A	COPERCHIO SONDA TEMPERATURA CT BT CON PA		KVM1464A	KIT COPERCHIO SONDA TEMP CT BT VM1464A0	<table border="1"> <thead> <tr> <th>Codice</th> <th>Descrizione</th> <th>Qtà</th> <th>UM</th> </tr> </thead> <tbody> <tr> <td>VM1464A0</td> <td>COPERCHIO SONDA TEMPERATUR A CT BT CON PA</td> <td>1</td> <td>PZ</td> </tr> </tbody> </table>	Codice	Descrizione	Qtà	UM	VM1464A0	COPERCHIO SONDA TEMPERATUR A CT BT CON PA	1	PZ																				
Codice	Descrizione	Qtà	UM																														
VM1464A0	COPERCHIO SONDA TEMPERATUR A CT BT CON PA	1	PZ																														

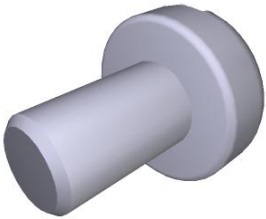

COMPONENTE			RICAMBIO																														
Codice	Descrizione	Immagine	Codice	Descrizione	Lista componenti																												
TR1003A	SONDA TEMPERATURA UL PT100 L2000 USA		KTR1003B	KIT SONDA TEMP CAMERA L2000 MINDMAPS USA	<table border="1"> <thead> <tr> <th>Codice</th> <th>Descrizione</th> <th>Qtà</th> <th>UM</th> </tr> </thead> <tbody> <tr> <td>GN1285A0</td> <td>GUARNIZIONE SONDA DI TEMPERATUR A NTC</td> <td>1</td> <td>PZ</td> </tr> <tr> <td>SL1045A0</td> <td>SILICONE ANTRACITE S53 80 ML</td> <td>1</td> <td>PZ</td> </tr> <tr> <td>TR1003B0</td> <td>SONDA TEMPERATUR A UL PT100 L 2000 USA</td> <td>1</td> <td>PZ</td> </tr> <tr> <td>VI1220A1</td> <td>VITE AUTOFILETTA NTE 4.2X11 TCS+ MARUTE</td> <td>2</td> <td>PZ</td> </tr> <tr> <td>VM1464A0</td> <td>COPERCHIO SONDA TEMPERATUR A CT BT CON PA</td> <td>1</td> <td>PZ</td> </tr> <tr> <td>VM1465A0</td> <td>COPERCHIO SONDA TEMPERATUR A CHEFTOP</td> <td>1</td> <td>PZ</td> </tr> </tbody> </table>	Codice	Descrizione	Qtà	UM	GN1285A0	GUARNIZIONE SONDA DI TEMPERATUR A NTC	1	PZ	SL1045A0	SILICONE ANTRACITE S53 80 ML	1	PZ	TR1003B0	SONDA TEMPERATUR A UL PT100 L 2000 USA	1	PZ	VI1220A1	VITE AUTOFILETTA NTE 4.2X11 TCS+ MARUTE	2	PZ	VM1464A0	COPERCHIO SONDA TEMPERATUR A CT BT CON PA	1	PZ	VM1465A0	COPERCHIO SONDA TEMPERATUR A CHEFTOP	1	PZ
			Codice	Descrizione	Qtà	UM																											
GN1285A0	GUARNIZIONE SONDA DI TEMPERATUR A NTC	1	PZ																														
SL1045A0	SILICONE ANTRACITE S53 80 ML	1	PZ																														
TR1003B0	SONDA TEMPERATUR A UL PT100 L 2000 USA	1	PZ																														
VI1220A1	VITE AUTOFILETTA NTE 4.2X11 TCS+ MARUTE	2	PZ																														
VM1464A0	COPERCHIO SONDA TEMPERATUR A CT BT CON PA	1	PZ																														
VM1465A0	COPERCHIO SONDA TEMPERATUR A CHEFTOP	1	PZ																														
KTR1003A	KIT SONDA TEMP CAMERA L2000 S 5-5E USA	<table border="1"> <thead> <tr> <th>Codice</th> <th>Descrizione</th> <th>Qtà</th> <th>UM</th> </tr> </thead> <tbody> <tr> <td>GN1285A0</td> <td>GUARNIZIONE SONDA DI TEMPERATUR A NTC</td> <td>1</td> <td>PZ</td> </tr> <tr> <td>SL1045A0</td> <td>SILICONE ANTRACITE S53 80 ML</td> <td>1</td> <td>PZ</td> </tr> <tr> <td>TR1003A0</td> <td>SONDA TEMPERATUR A UL PT100 L2000 USA</td> <td>1</td> <td>PZ</td> </tr> <tr> <td>VI1220A1</td> <td>VITE AUTOFILETTA NTE 4.2X11 TCS+ MARUTE</td> <td>2</td> <td>PZ</td> </tr> <tr> <td>VM1465A0</td> <td>COPERCHIO SONDA TEMPERATUR A CHEFTOP</td> <td>1</td> <td>PZ</td> </tr> </tbody> </table>	Codice	Descrizione	Qtà	UM	GN1285A0	GUARNIZIONE SONDA DI TEMPERATUR A NTC	1	PZ	SL1045A0	SILICONE ANTRACITE S53 80 ML	1	PZ	TR1003A0	SONDA TEMPERATUR A UL PT100 L2000 USA	1	PZ	VI1220A1	VITE AUTOFILETTA NTE 4.2X11 TCS+ MARUTE	2	PZ	VM1465A0	COPERCHIO SONDA TEMPERATUR A CHEFTOP	1	PZ							
Codice	Descrizione	Qtà	UM																														
GN1285A0	GUARNIZIONE SONDA DI TEMPERATUR A NTC	1	PZ																														
SL1045A0	SILICONE ANTRACITE S53 80 ML	1	PZ																														
TR1003A0	SONDA TEMPERATUR A UL PT100 L2000 USA	1	PZ																														
VI1220A1	VITE AUTOFILETTA NTE 4.2X11 TCS+ MARUTE	2	PZ																														
VM1465A0	COPERCHIO SONDA TEMPERATUR A CHEFTOP	1	PZ																														

COMPONENTE			RICAMBIO																														
Codice	Descrizione	Immagine	Codice	Descrizione	Lista componenti																												
GN1531A	GUARNIZIONE TENUTA INGRESSO BULBO		KTR1136A	KIT TERMOSTATO SICUREZZA 330°C	<table border="1"> <thead> <tr> <th>Codice</th> <th>Descrizione</th> <th>Qtà</th> <th>UM</th> </tr> </thead> <tbody> <tr> <td>0H7030A0</td> <td>COPERCHIO INGRESSO BULBO</td> <td>1</td> <td>PZ</td> </tr> <tr> <td>GN1531A0</td> <td>GUARNIZIONE TENUTA INGRESSO BULBO</td> <td>1</td> <td>PZ</td> </tr> <tr> <td>SL1045A0</td> <td>SILICONE ANTRACITE S53 80 ML</td> <td>1</td> <td>PZ</td> </tr> <tr> <td>TR1136A0</td> <td>TERMOSTATO SIC. UNIP. 330°C</td> <td>1</td> <td>PZ</td> </tr> <tr> <td>VI1220A1</td> <td>VITE AUTOFILETTA NTE 4.2X11 TCS+ MARUTE</td> <td>3</td> <td>PZ</td> </tr> </tbody> </table>	Codice	Descrizione	Qtà	UM	0H7030A0	COPERCHIO INGRESSO BULBO	1	PZ	GN1531A0	GUARNIZIONE TENUTA INGRESSO BULBO	1	PZ	SL1045A0	SILICONE ANTRACITE S53 80 ML	1	PZ	TR1136A0	TERMOSTATO SIC. UNIP. 330°C	1	PZ	VI1220A1	VITE AUTOFILETTA NTE 4.2X11 TCS+ MARUTE	3	PZ				
Codice	Descrizione	Qtà	UM																														
0H7030A0	COPERCHIO INGRESSO BULBO	1	PZ																														
GN1531A0	GUARNIZIONE TENUTA INGRESSO BULBO	1	PZ																														
SL1045A0	SILICONE ANTRACITE S53 80 ML	1	PZ																														
TR1136A0	TERMOSTATO SIC. UNIP. 330°C	1	PZ																														
VI1220A1	VITE AUTOFILETTA NTE 4.2X11 TCS+ MARUTE	3	PZ																														
0H7030A	COPERCHIO INGRESSO BULBO		K0H7030A	KIT COPERCHIO INGRESSO BULBO 1PZ	<table border="1"> <thead> <tr> <th>Codice</th> <th>Descrizione</th> <th>Qtà</th> <th>UM</th> </tr> </thead> <tbody> <tr> <td>0H7030A0</td> <td>COPERCHIO INGRESSO BULBO</td> <td>1</td> <td>PZ</td> </tr> </tbody> </table>	Codice	Descrizione	Qtà	UM	0H7030A0	COPERCHIO INGRESSO BULBO	1	PZ																				
Codice	Descrizione	Qtà	UM																														
0H7030A0	COPERCHIO INGRESSO BULBO	1	PZ																														
VL1037A	GIRANTE LAVAGGIO		KVL1037A	KIT RICAMBIO GIRANTE LAVAGGIO	<table border="1"> <thead> <tr> <th>Codice</th> <th>Descrizione</th> <th>Qtà</th> <th>UM</th> </tr> </thead> <tbody> <tr> <td>GN1416B0</td> <td>BRONZINA GIRANTE LAVAGGIO</td> <td>1</td> <td>PZ</td> </tr> <tr> <td>TF1065B0</td> <td>PERNO ROTAZIONE GIRANTE LAVAGGIO</td> <td>1</td> <td>PZ</td> </tr> <tr> <td>TF1066A1</td> <td>BOCCOLA GIRANTE LAVAGGIO</td> <td>1</td> <td>PZ</td> </tr> <tr> <td>UG1005B1</td> <td>UGELLO ACQUA GETTO LARGO GIRANTE</td> <td>1</td> <td>PZ</td> </tr> <tr> <td>UG1006B3</td> <td>UGELLO ACQUA GETTO LUNGO GIRANTE</td> <td>1</td> <td>PZ</td> </tr> <tr> <td>VI1220A1</td> <td>VITE AUTOFILETTA NTE 4.2X11 TCS+ MARUTE</td> <td>6</td> <td>PZ</td> </tr> </tbody> </table>	Codice	Descrizione	Qtà	UM	GN1416B0	BRONZINA GIRANTE LAVAGGIO	1	PZ	TF1065B0	PERNO ROTAZIONE GIRANTE LAVAGGIO	1	PZ	TF1066A1	BOCCOLA GIRANTE LAVAGGIO	1	PZ	UG1005B1	UGELLO ACQUA GETTO LARGO GIRANTE	1	PZ	UG1006B3	UGELLO ACQUA GETTO LUNGO GIRANTE	1	PZ	VI1220A1	VITE AUTOFILETTA NTE 4.2X11 TCS+ MARUTE	6	PZ
Codice	Descrizione	Qtà	UM																														
GN1416B0	BRONZINA GIRANTE LAVAGGIO	1	PZ																														
TF1065B0	PERNO ROTAZIONE GIRANTE LAVAGGIO	1	PZ																														
TF1066A1	BOCCOLA GIRANTE LAVAGGIO	1	PZ																														
UG1005B1	UGELLO ACQUA GETTO LARGO GIRANTE	1	PZ																														
UG1006B3	UGELLO ACQUA GETTO LUNGO GIRANTE	1	PZ																														
VI1220A1	VITE AUTOFILETTA NTE 4.2X11 TCS+ MARUTE	6	PZ																														

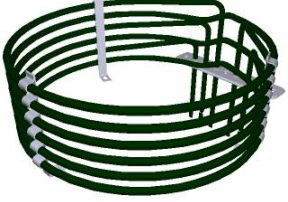
COMPONENTE			RICAMBIO																		
Codice	Descrizione	Immagine	Codice	Descrizione	Lista componenti																
VL1037A	GIRANTE LAVAGGIO		KVL1037A	KIT RICAMBIO GIRANTE LAVAGGIO	<table border="1"> <thead> <tr> <th>Codice</th> <th>Descrizione</th> <th>Qtà</th> <th>UM</th> </tr> </thead> <tbody> <tr> <td>VM1955C0</td> <td>CORPO GIRANTE LAVAGGIO</td> <td>1</td> <td>PZ</td> </tr> <tr> <td>VM1985C1</td> <td>COPERCHIO GIRANTE LAVAGGIO</td> <td>1</td> <td>PZ</td> </tr> <tr> <td>VM1986A0</td> <td>TAPPO UGELL</td> <td>1</td> <td>PZ</td> </tr> </tbody> </table>	Codice	Descrizione	Qtà	UM	VM1955C0	CORPO GIRANTE LAVAGGIO	1	PZ	VM1985C1	COPERCHIO GIRANTE LAVAGGIO	1	PZ	VM1986A0	TAPPO UGELL	1	PZ
Codice	Descrizione	Qtà	UM																		
VM1955C0	CORPO GIRANTE LAVAGGIO	1	PZ																		
VM1985C1	COPERCHIO GIRANTE LAVAGGIO	1	PZ																		
VM1986A0	TAPPO UGELL	1	PZ																		
0H2551A	TAPPO PER TUBO DI SCARICO LIQUIDI INOX C		0H2551A0	TAPPO PER TUBO DI SCARICO LIQUIDI INOX C																	
0H7320A	SUPPORTO TUBO VENTURI MM		0H7320A0	SUPPORTO TUBO VENTURI MM																	
VM1820A	NOTTOLINO M6 CROMATO FISS. SUPPORTI		KVM1820A	KIT 10 NOTTOLINI S.	<table border="1"> <thead> <tr> <th>Codice</th> <th>Descrizione</th> <th>Qtà</th> <th>UM</th> </tr> </thead> <tbody> <tr> <td>VM1820A0</td> <td>NOTTOLINO M6 CROMATO FISS. SUPPORTI</td> <td>10</td> <td>PZ</td> </tr> </tbody> </table>	Codice	Descrizione	Qtà	UM	VM1820A0	NOTTOLINO M6 CROMATO FISS. SUPPORTI	10	PZ								
Codice	Descrizione	Qtà	UM																		
VM1820A0	NOTTOLINO M6 CROMATO FISS. SUPPORTI	10	PZ																		
0G1558A	DISTANZIALE CARTER ARIA		K0G1558A	KIT DISTANZIALE CARTER ARIA	<table border="1"> <thead> <tr> <th>Codice</th> <th>Descrizione</th> <th>Qtà</th> <th>UM</th> </tr> </thead> <tbody> <tr> <td>0G1558A0</td> <td>DISTANZIALE CARTER ARIA</td> <td>1</td> <td>PZ</td> </tr> <tr> <td>IP1508A1</td> <td>POLISTIROLO PROFILO AD U 2000X60X60</td> <td>1.400</td> <td>M</td> </tr> <tr> <td>VM1059A1</td> <td>FILM TERMORETRA IBILE H800</td> <td>1.500</td> <td>M</td> </tr> </tbody> </table>	Codice	Descrizione	Qtà	UM	0G1558A0	DISTANZIALE CARTER ARIA	1	PZ	IP1508A1	POLISTIROLO PROFILO AD U 2000X60X60	1.400	M	VM1059A1	FILM TERMORETRA IBILE H800	1.500	M
Codice	Descrizione	Qtà	UM																		
0G1558A0	DISTANZIALE CARTER ARIA	1	PZ																		
IP1508A1	POLISTIROLO PROFILO AD U 2000X60X60	1.400	M																		
VM1059A1	FILM TERMORETRA IBILE H800	1.500	M																		

COMPONENTE			RICAMBIO																																										
Codice	Descrizione	Immagine	Codice	Descrizione	Lista componenti																																								
VM2331A	PERNO M6 FERMA CARTER-SUPPORT O TEGLIE		KVM2331A	KIT PERN M6 FERMA CARTER-SUPPORT O TEGLIE	<table border="1"> <thead> <tr> <th>Codice</th> <th>Descrizione</th> <th>Qtà</th> <th>UM</th> </tr> </thead> <tbody> <tr> <td>VM2331A0</td> <td>PERNO M6 FERMA CARTER-SUPP ORTO TEGLIE</td> <td>4</td> <td>PZ</td> </tr> </tbody> </table>	Codice	Descrizione	Qtà	UM	VM2331A0	PERNO M6 FERMA CARTER-SUPP ORTO TEGLIE	4	PZ																																
Codice	Descrizione	Qtà	UM																																										
VM2331A0	PERNO M6 FERMA CARTER-SUPP ORTO TEGLIE	4	PZ																																										
GN1085A	GUARNIZIONE RESISTENZA 141X24 G6.25		KGN1085A	KIT GUARNIZIONE RESISTENZA GN1085A2	<table border="1"> <thead> <tr> <th>Codice</th> <th>Descrizione</th> <th>Qtà</th> <th>UM</th> </tr> </thead> <tbody> <tr> <td>GN1085A2</td> <td>GUARNIZIONE RESISTENZA 141X24 G6.25</td> <td>1</td> <td>PZ</td> </tr> </tbody> </table>	Codice	Descrizione	Qtà	UM	GN1085A2	GUARNIZIONE RESISTENZA 141X24 G6.25	1	PZ																																
Codice	Descrizione	Qtà	UM																																										
GN1085A2	GUARNIZIONE RESISTENZA 141X24 G6.25	1	PZ																																										
RS1267A	RES. CIRCOLARE 10KW 230V 6 SPIRE		KRS1267A	KIT RES.CIRCOLARE 105KW 230V 6 SPIRE	<table border="1"> <thead> <tr> <th>Codice</th> <th>Descrizione</th> <th>Qtà</th> <th>UM</th> </tr> </thead> <tbody> <tr> <td>GN1086A0</td> <td>GUARNIZIONE RESISTENZA 141X22 G8.5</td> <td>1</td> <td>PZ</td> </tr> <tr> <td>RS1267A0</td> <td>RES. CIRCOLARE 10KW 230V 6 SPIRE</td> <td>1</td> <td>PZ</td> </tr> <tr> <td>SL1045A0</td> <td>SILICONE ANTRACITE S53 80 ML</td> <td>1</td> <td>PZ</td> </tr> <tr> <td>VI1032A0</td> <td>VITE M4X16 TCB+ INOX</td> <td>1</td> <td>PZ</td> </tr> <tr> <td>VI1075A0</td> <td>DADO M4 H=4 INOX UNI5587</td> <td>1</td> <td>PZ</td> </tr> <tr> <td>VI1220A1</td> <td>VITE AUTOFILETTA NTE 4.2X11 TCS+ MARUTE</td> <td>6</td> <td>PZ</td> </tr> <tr> <td>VI1511A0</td> <td>RONDELLA PIANA 4.2X12X1 INOX</td> <td>1</td> <td>PZ</td> </tr> <tr> <td>VM1794A0</td> <td>FASCETTA 250X4.8 PA66 NERA</td> <td>2</td> <td>PZ</td> </tr> <tr> <td>VM2103A0</td> <td>PIASTRINA FERMAFASCE TTA</td> <td>2</td> <td>PZ</td> </tr> </tbody> </table>	Codice	Descrizione	Qtà	UM	GN1086A0	GUARNIZIONE RESISTENZA 141X22 G8.5	1	PZ	RS1267A0	RES. CIRCOLARE 10KW 230V 6 SPIRE	1	PZ	SL1045A0	SILICONE ANTRACITE S53 80 ML	1	PZ	VI1032A0	VITE M4X16 TCB+ INOX	1	PZ	VI1075A0	DADO M4 H=4 INOX UNI5587	1	PZ	VI1220A1	VITE AUTOFILETTA NTE 4.2X11 TCS+ MARUTE	6	PZ	VI1511A0	RONDELLA PIANA 4.2X12X1 INOX	1	PZ	VM1794A0	FASCETTA 250X4.8 PA66 NERA	2	PZ	VM2103A0	PIASTRINA FERMAFASCE TTA	2	PZ
Codice	Descrizione	Qtà	UM																																										
GN1086A0	GUARNIZIONE RESISTENZA 141X22 G8.5	1	PZ																																										
RS1267A0	RES. CIRCOLARE 10KW 230V 6 SPIRE	1	PZ																																										
SL1045A0	SILICONE ANTRACITE S53 80 ML	1	PZ																																										
VI1032A0	VITE M4X16 TCB+ INOX	1	PZ																																										
VI1075A0	DADO M4 H=4 INOX UNI5587	1	PZ																																										
VI1220A1	VITE AUTOFILETTA NTE 4.2X11 TCS+ MARUTE	6	PZ																																										
VI1511A0	RONDELLA PIANA 4.2X12X1 INOX	1	PZ																																										
VM1794A0	FASCETTA 250X4.8 PA66 NERA	2	PZ																																										
VM2103A0	PIASTRINA FERMAFASCE TTA	2	PZ																																										

COMPONENTE			RICAMBIO																																										
Codice	Descrizione	Immagine	Codice	Descrizione	Lista componenti																																								
GN1085A	GUARNIZIONE RESISTENZA 141X24 G6.25		KG1085A	KIT GUARNIZIONE RESISTENZA GN1085A2	<table border="1"> <thead> <tr> <th>Codice</th> <th>Descrizione</th> <th>Qtà</th> <th>UM</th> </tr> </thead> <tbody> <tr> <td>GN1085A2</td> <td>GUARNIZIONE RESISTENZA 141X24 G6.25</td> <td>1</td> <td>PZ</td> </tr> </tbody> </table>	Codice	Descrizione	Qtà	UM	GN1085A2	GUARNIZIONE RESISTENZA 141X24 G6.25	1	PZ																																
Codice	Descrizione	Qtà	UM																																										
GN1085A2	GUARNIZIONE RESISTENZA 141X24 G6.25	1	PZ																																										
RS1225A	RES. CIRCOLARE 4700W 230V D230 6 SPIRE		KRS1225A	KIT RESISTENZA CIRCOLARE 4.7KW 6 SPIRE	<table border="1"> <thead> <tr> <th>Codice</th> <th>Descrizione</th> <th>Qtà</th> <th>UM</th> </tr> </thead> <tbody> <tr> <td>GN1085A2</td> <td>GUARNIZIONE RESISTENZA 141X24 G6.25</td> <td>1</td> <td>PZ</td> </tr> <tr> <td>RS1225A1</td> <td>RES. CIRCOLARE 4700W 230V D230 6 SPIRE</td> <td>1</td> <td>PZ</td> </tr> <tr> <td>SL1045A0</td> <td>SILICONE ANTRACITE S53 80 ML</td> <td>1</td> <td>PZ</td> </tr> <tr> <td>VI1032A0</td> <td>VITE M4X16 TCB+ INOX</td> <td>1</td> <td>PZ</td> </tr> <tr> <td>VI1075A0</td> <td>DADO M4 H=4 INOX UNI5587</td> <td>1</td> <td>PZ</td> </tr> <tr> <td>VI1220A1</td> <td>VITE AUTOFILETTA NTE 4.2X11 TCS+ MARUTE</td> <td>6</td> <td>PZ</td> </tr> <tr> <td>VI1511A0</td> <td>RONDELLA PIANA 4.2X12X1 INOX</td> <td>1</td> <td>PZ</td> </tr> <tr> <td>VM1794A0</td> <td>FASCETTA 250X4.8 PA66 NERA</td> <td>2</td> <td>PZ</td> </tr> <tr> <td>VM2103A0</td> <td>PIASTRINA FERMAFASCE TTA</td> <td>2</td> <td>PZ</td> </tr> </tbody> </table>	Codice	Descrizione	Qtà	UM	GN1085A2	GUARNIZIONE RESISTENZA 141X24 G6.25	1	PZ	RS1225A1	RES. CIRCOLARE 4700W 230V D230 6 SPIRE	1	PZ	SL1045A0	SILICONE ANTRACITE S53 80 ML	1	PZ	VI1032A0	VITE M4X16 TCB+ INOX	1	PZ	VI1075A0	DADO M4 H=4 INOX UNI5587	1	PZ	VI1220A1	VITE AUTOFILETTA NTE 4.2X11 TCS+ MARUTE	6	PZ	VI1511A0	RONDELLA PIANA 4.2X12X1 INOX	1	PZ	VM1794A0	FASCETTA 250X4.8 PA66 NERA	2	PZ	VM2103A0	PIASTRINA FERMAFASCE TTA	2	PZ
Codice	Descrizione	Qtà	UM																																										
GN1085A2	GUARNIZIONE RESISTENZA 141X24 G6.25	1	PZ																																										
RS1225A1	RES. CIRCOLARE 4700W 230V D230 6 SPIRE	1	PZ																																										
SL1045A0	SILICONE ANTRACITE S53 80 ML	1	PZ																																										
VI1032A0	VITE M4X16 TCB+ INOX	1	PZ																																										
VI1075A0	DADO M4 H=4 INOX UNI5587	1	PZ																																										
VI1220A1	VITE AUTOFILETTA NTE 4.2X11 TCS+ MARUTE	6	PZ																																										
VI1511A0	RONDELLA PIANA 4.2X12X1 INOX	1	PZ																																										
VM1794A0	FASCETTA 250X4.8 PA66 NERA	2	PZ																																										
VM2103A0	PIASTRINA FERMAFASCE TTA	2	PZ																																										
GN1085A	GUARNIZIONE RESISTENZA 141X24 G6.25		KG1085A	KIT GUARNIZIONE RESISTENZA GN1085A2	<table border="1"> <thead> <tr> <th>Codice</th> <th>Descrizione</th> <th>Qtà</th> <th>UM</th> </tr> </thead> <tbody> <tr> <td>GN1085A2</td> <td>GUARNIZIONE RESISTENZA 141X24 G6.25</td> <td>1</td> <td>PZ</td> </tr> </tbody> </table>	Codice	Descrizione	Qtà	UM	GN1085A2	GUARNIZIONE RESISTENZA 141X24 G6.25	1	PZ																																
Codice	Descrizione	Qtà	UM																																										
GN1085A2	GUARNIZIONE RESISTENZA 141X24 G6.25	1	PZ																																										

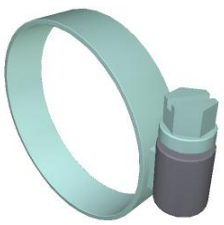
COMPONENTE			RICAMBIO																																		
Codice	Descrizione	Immagine	Codice	Descrizione	Lista componenti																																
RS1002A	RES. CIRCOLARE 6750W 230V 6 SPIRE		KRS1002A	KIT RESISTENZA 6750W 230V 6 SPIRE	<table border="1"> <thead> <tr> <th>Codice</th> <th>Descrizione</th> <th>Qtà</th> <th>UM</th> </tr> </thead> <tbody> <tr> <td>GN1086A0</td> <td>GUARNIZIONE RESISTENZA 141X22 G8.5</td> <td>1</td> <td>PZ</td> </tr> <tr> <td>RS1002A1</td> <td>RES. CIRCOLARE 6750W 230V 6 SPIRE</td> <td>1</td> <td>PZ</td> </tr> <tr> <td>SL1045A0</td> <td>SILICONE ANTRACITE S53 80 ML</td> <td>1</td> <td>PZ</td> </tr> <tr> <td>VI1220A1</td> <td>VITE AUTOFILETTA NTE 4.2X11 TCS+ MARUTE</td> <td>5</td> <td>PZ</td> </tr> <tr> <td>VM1794A0</td> <td>FASCETTA 250X4.8 PA66 NERA</td> <td>2</td> <td>PZ</td> </tr> <tr> <td>VM2103A0</td> <td>PIASTRINA FERMAFASCE TTA</td> <td>2</td> <td>PZ</td> </tr> </tbody> </table>	Codice	Descrizione	Qtà	UM	GN1086A0	GUARNIZIONE RESISTENZA 141X22 G8.5	1	PZ	RS1002A1	RES. CIRCOLARE 6750W 230V 6 SPIRE	1	PZ	SL1045A0	SILICONE ANTRACITE S53 80 ML	1	PZ	VI1220A1	VITE AUTOFILETTA NTE 4.2X11 TCS+ MARUTE	5	PZ	VM1794A0	FASCETTA 250X4.8 PA66 NERA	2	PZ	VM2103A0	PIASTRINA FERMAFASCE TTA	2	PZ				
Codice	Descrizione	Qtà	UM																																		
GN1086A0	GUARNIZIONE RESISTENZA 141X22 G8.5	1	PZ																																		
RS1002A1	RES. CIRCOLARE 6750W 230V 6 SPIRE	1	PZ																																		
SL1045A0	SILICONE ANTRACITE S53 80 ML	1	PZ																																		
VI1220A1	VITE AUTOFILETTA NTE 4.2X11 TCS+ MARUTE	5	PZ																																		
VM1794A0	FASCETTA 250X4.8 PA66 NERA	2	PZ																																		
VM2103A0	PIASTRINA FERMAFASCE TTA	2	PZ																																		
0H2730A	STAFFA ZINCATA SOSTEGNO MUFFOLA																																				
RC1378A	FASCETTA STRINGI TUBO ZINCATA		KVE1135A	KIT RICAMBIO VENTURI FORNI SERIE 5/E	<table border="1"> <thead> <tr> <th>Codice</th> <th>Descrizione</th> <th>Qtà</th> <th>UM</th> </tr> </thead> <tbody> <tr> <td>GN1310A0</td> <td>GUARNIZIONE PIATTELLO VENTURI SILICONE</td> <td>1</td> <td>PZ</td> </tr> <tr> <td>GN1556A0</td> <td>GUARNIZIONE VENTURI MM</td> <td>1</td> <td>PZ</td> </tr> <tr> <td>RC1378A0</td> <td>FASCETTA STRINGI TUBO ZINCATA</td> <td>2</td> <td>PZ</td> </tr> <tr> <td>TB1520A0</td> <td>TUBO D.INT=30 SP=4 GOMMA EPDM NERO</td> <td>0.050</td> <td>M</td> </tr> <tr> <td>VE1135A0</td> <td>ATTUATORE VENTURI 220V 50/60 HZ SERIE 2</td> <td>1</td> <td>PZ</td> </tr> <tr> <td>VI1032A0</td> <td>VITE M4X16 TCB+ INOX</td> <td>1</td> <td>PZ</td> </tr> <tr> <td>VI1511A0</td> <td>RONDELLA PIANA 4.2X12X1 INOX</td> <td>2</td> <td>PZ</td> </tr> </tbody> </table>	Codice	Descrizione	Qtà	UM	GN1310A0	GUARNIZIONE PIATTELLO VENTURI SILICONE	1	PZ	GN1556A0	GUARNIZIONE VENTURI MM	1	PZ	RC1378A0	FASCETTA STRINGI TUBO ZINCATA	2	PZ	TB1520A0	TUBO D.INT=30 SP=4 GOMMA EPDM NERO	0.050	M	VE1135A0	ATTUATORE VENTURI 220V 50/60 HZ SERIE 2	1	PZ	VI1032A0	VITE M4X16 TCB+ INOX	1	PZ	VI1511A0	RONDELLA PIANA 4.2X12X1 INOX	2	PZ
Codice	Descrizione	Qtà	UM																																		
GN1310A0	GUARNIZIONE PIATTELLO VENTURI SILICONE	1	PZ																																		
GN1556A0	GUARNIZIONE VENTURI MM	1	PZ																																		
RC1378A0	FASCETTA STRINGI TUBO ZINCATA	2	PZ																																		
TB1520A0	TUBO D.INT=30 SP=4 GOMMA EPDM NERO	0.050	M																																		
VE1135A0	ATTUATORE VENTURI 220V 50/60 HZ SERIE 2	1	PZ																																		
VI1032A0	VITE M4X16 TCB+ INOX	1	PZ																																		
VI1511A0	RONDELLA PIANA 4.2X12X1 INOX	2	PZ																																		



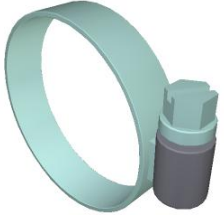
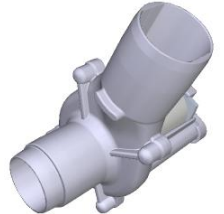

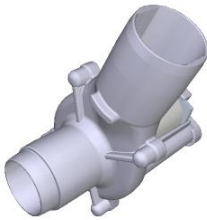



COMPONENTE			RICAMBIO																																																		
Codice	Descrizione	Immagine	Codice	Descrizione	Lista componenti																																																
RC1378A	FASCETTA STRINGI TUBO ZINCATA		KVE1135A	KIT RICAMBIO VENTURI FORNI SERIE 5/E	<table border="1"> <thead> <tr> <th>Codice</th> <th>Descrizione</th> <th>Qtà</th> <th>UM</th> </tr> </thead> <tbody> <tr> <td>VI1850A0</td> <td>VITE M4X6 TCB+ NICHELATA</td> <td>2</td> <td>PZ</td> </tr> <tr> <td>VI1865A0</td> <td>VITE AUTOFIL. 5X10 TCB+</td> <td>3</td> <td>PZ</td> </tr> <tr> <td>VM1565B0</td> <td>BOBINA INFERIORE VENTURI CT B</td> <td>1</td> <td>PZ</td> </tr> <tr> <td>VM1566A0</td> <td>PORTA BOBINA SUPERIORE VENTURI</td> <td>1</td> <td>PZ</td> </tr> <tr> <td>VM1567A0</td> <td>BOCCOLA INFERIORE VENTURI</td> <td>1</td> <td>PZ</td> </tr> <tr> <td>VM1568A0</td> <td>DISTANZIALE PIATTELLO VENTURI</td> <td>1</td> <td>PZ</td> </tr> </tbody> </table>	Codice	Descrizione	Qtà	UM	VI1850A0	VITE M4X6 TCB+ NICHELATA	2	PZ	VI1865A0	VITE AUTOFIL. 5X10 TCB+	3	PZ	VM1565B0	BOBINA INFERIORE VENTURI CT B	1	PZ	VM1566A0	PORTA BOBINA SUPERIORE VENTURI	1	PZ	VM1567A0	BOCCOLA INFERIORE VENTURI	1	PZ	VM1568A0	DISTANZIALE PIATTELLO VENTURI	1	PZ																				
Codice	Descrizione	Qtà	UM																																																		
VI1850A0	VITE M4X6 TCB+ NICHELATA	2	PZ																																																		
VI1865A0	VITE AUTOFIL. 5X10 TCB+	3	PZ																																																		
VM1565B0	BOBINA INFERIORE VENTURI CT B	1	PZ																																																		
VM1566A0	PORTA BOBINA SUPERIORE VENTURI	1	PZ																																																		
VM1567A0	BOCCOLA INFERIORE VENTURI	1	PZ																																																		
VM1568A0	DISTANZIALE PIATTELLO VENTURI	1	PZ																																																		
VM2377A	ASM VENTURI 220V 50/60 HZ		KVM2377A	KIT ASSIEME ATTUATORE VENTURI MM	<table border="1"> <thead> <tr> <th>Codice</th> <th>Descrizione</th> <th>Qtà</th> <th>UM</th> </tr> </thead> <tbody> <tr> <td>GN1556A0</td> <td>GUARNIZIONE VENTURI MM</td> <td>1</td> <td>PZ</td> </tr> <tr> <td>RC1378A0</td> <td>FASCETTA STRINGI TUBO ZINCATA</td> <td>3</td> <td>PZ</td> </tr> <tr> <td>TB1520A0</td> <td>TUBO D.INT=30 SP=4 GOMMA EPDM NERO</td> <td>0.170</td> <td>M</td> </tr> <tr> <td>VE1135A0</td> <td>ATTUATORE VENTURI 220V 50/60 HZ SERIE 2</td> <td>1</td> <td>PZ</td> </tr> <tr> <td>VI1032A0</td> <td>VITE M4X16 TCB+ INOX</td> <td>1</td> <td>PZ</td> </tr> <tr> <td>VI1220A1</td> <td>VITE AUTOFILETTA NTE 4.2X11 TCS+ MARUTE</td> <td>6</td> <td>PZ</td> </tr> <tr> <td>VM2345A0</td> <td>CORPO SUPERIORE VENTURI MM</td> <td>1</td> <td>PZ</td> </tr> <tr> <td>VM2346A0</td> <td>CORPO INFERIORE VENTURI MM</td> <td>1</td> <td>PZ</td> </tr> <tr> <td>VM2347A0</td> <td>COPERCHIETT O VENTURI MIND.MAPS</td> <td>1</td> <td>PZ</td> </tr> <tr> <td>VM2348A0</td> <td>DISTANZIALE PIATTELLO VENTURI</td> <td>1</td> <td>PZ</td> </tr> <tr> <td>VM2349A0</td> <td>BOCCOLA INFERIORE VENTURI</td> <td>1</td> <td>PZ</td> </tr> </tbody> </table>	Codice	Descrizione	Qtà	UM	GN1556A0	GUARNIZIONE VENTURI MM	1	PZ	RC1378A0	FASCETTA STRINGI TUBO ZINCATA	3	PZ	TB1520A0	TUBO D.INT=30 SP=4 GOMMA EPDM NERO	0.170	M	VE1135A0	ATTUATORE VENTURI 220V 50/60 HZ SERIE 2	1	PZ	VI1032A0	VITE M4X16 TCB+ INOX	1	PZ	VI1220A1	VITE AUTOFILETTA NTE 4.2X11 TCS+ MARUTE	6	PZ	VM2345A0	CORPO SUPERIORE VENTURI MM	1	PZ	VM2346A0	CORPO INFERIORE VENTURI MM	1	PZ	VM2347A0	COPERCHIETT O VENTURI MIND.MAPS	1	PZ	VM2348A0	DISTANZIALE PIATTELLO VENTURI	1	PZ	VM2349A0	BOCCOLA INFERIORE VENTURI	1	PZ
Codice	Descrizione	Qtà	UM																																																		
GN1556A0	GUARNIZIONE VENTURI MM	1	PZ																																																		
RC1378A0	FASCETTA STRINGI TUBO ZINCATA	3	PZ																																																		
TB1520A0	TUBO D.INT=30 SP=4 GOMMA EPDM NERO	0.170	M																																																		
VE1135A0	ATTUATORE VENTURI 220V 50/60 HZ SERIE 2	1	PZ																																																		
VI1032A0	VITE M4X16 TCB+ INOX	1	PZ																																																		
VI1220A1	VITE AUTOFILETTA NTE 4.2X11 TCS+ MARUTE	6	PZ																																																		
VM2345A0	CORPO SUPERIORE VENTURI MM	1	PZ																																																		
VM2346A0	CORPO INFERIORE VENTURI MM	1	PZ																																																		
VM2347A0	COPERCHIETT O VENTURI MIND.MAPS	1	PZ																																																		
VM2348A0	DISTANZIALE PIATTELLO VENTURI	1	PZ																																																		
VM2349A0	BOCCOLA INFERIORE VENTURI	1	PZ																																																		



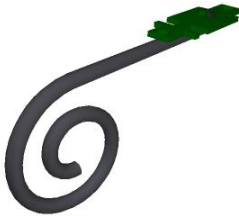

COMPONENTE			RICAMBIO																																																		
Codice	Descrizione	Immagine	Codice	Descrizione	Lista componenti																																																
VM2378A	ASM VENTURI 240V 50/60 HZ UL		KVM2378A	KIT ASSIEME ATTUATORE VENTURI 240V UL M	<table border="1"> <thead> <tr> <th>Codice</th> <th>Descrizione</th> <th>Qtà</th> <th>UM</th> </tr> </thead> <tbody> <tr> <td>GN1556A0</td> <td>GUARNIZIONE VENTURI MM</td> <td>1</td> <td>PZ</td> </tr> <tr> <td>RC1378A0</td> <td>FASCETTA STRINGI TUBO ZINCATA</td> <td>3</td> <td>PZ</td> </tr> <tr> <td>TB1520A0</td> <td>TUBO D.INT=30 SP=4 GOMMA EPDM NERO</td> <td>0.170</td> <td>M</td> </tr> <tr> <td>VE1014A0</td> <td>ATTUATORE VENTURI 240V 50/60HZ COMP. UL</td> <td>1</td> <td>PZ</td> </tr> <tr> <td>VI1032A0</td> <td>VITE M4X16 TCB+ INOX</td> <td>1</td> <td>PZ</td> </tr> <tr> <td>VI1220A1</td> <td>VITE AUTOFILETTA NTE 4.2X11 TCS+ MARUTE</td> <td>6</td> <td>PZ</td> </tr> <tr> <td>VM2345A0</td> <td>CORPO SUPERIORE VENTURI MM</td> <td>1</td> <td>PZ</td> </tr> <tr> <td>VM2346A0</td> <td>CORPO INFERIORE VENTURI MM</td> <td>1</td> <td>PZ</td> </tr> <tr> <td>VM2347A0</td> <td>COPERCHIETT O VENTURI MIND.MAPS</td> <td>1</td> <td>PZ</td> </tr> <tr> <td>VM2348A0</td> <td>DISTANZIALE PIATTELLO VENTURI</td> <td>1</td> <td>PZ</td> </tr> <tr> <td>VM2349A0</td> <td>BOCCOLA INFERIORE VENTURI</td> <td>1</td> <td>PZ</td> </tr> </tbody> </table>	Codice	Descrizione	Qtà	UM	GN1556A0	GUARNIZIONE VENTURI MM	1	PZ	RC1378A0	FASCETTA STRINGI TUBO ZINCATA	3	PZ	TB1520A0	TUBO D.INT=30 SP=4 GOMMA EPDM NERO	0.170	M	VE1014A0	ATTUATORE VENTURI 240V 50/60HZ COMP. UL	1	PZ	VI1032A0	VITE M4X16 TCB+ INOX	1	PZ	VI1220A1	VITE AUTOFILETTA NTE 4.2X11 TCS+ MARUTE	6	PZ	VM2345A0	CORPO SUPERIORE VENTURI MM	1	PZ	VM2346A0	CORPO INFERIORE VENTURI MM	1	PZ	VM2347A0	COPERCHIETT O VENTURI MIND.MAPS	1	PZ	VM2348A0	DISTANZIALE PIATTELLO VENTURI	1	PZ	VM2349A0	BOCCOLA INFERIORE VENTURI	1	PZ
Codice	Descrizione	Qtà	UM																																																		
GN1556A0	GUARNIZIONE VENTURI MM	1	PZ																																																		
RC1378A0	FASCETTA STRINGI TUBO ZINCATA	3	PZ																																																		
TB1520A0	TUBO D.INT=30 SP=4 GOMMA EPDM NERO	0.170	M																																																		
VE1014A0	ATTUATORE VENTURI 240V 50/60HZ COMP. UL	1	PZ																																																		
VI1032A0	VITE M4X16 TCB+ INOX	1	PZ																																																		
VI1220A1	VITE AUTOFILETTA NTE 4.2X11 TCS+ MARUTE	6	PZ																																																		
VM2345A0	CORPO SUPERIORE VENTURI MM	1	PZ																																																		
VM2346A0	CORPO INFERIORE VENTURI MM	1	PZ																																																		
VM2347A0	COPERCHIETT O VENTURI MIND.MAPS	1	PZ																																																		
VM2348A0	DISTANZIALE PIATTELLO VENTURI	1	PZ																																																		
VM2349A0	BOCCOLA INFERIORE VENTURI	1	PZ																																																		
VM2379A	ASM BOBINA VENTURI 200V 50/60 HZ		KVM2379A	KIT ASSIEME ATTUATORE VENTURI MM	<table border="1"> <thead> <tr> <th>Codice</th> <th>Descrizione</th> <th>Qtà</th> <th>UM</th> </tr> </thead> <tbody> <tr> <td>GN1556A0</td> <td>GUARNIZIONE VENTURI MM</td> <td>1</td> <td>PZ</td> </tr> <tr> <td>RC1378A0</td> <td>FASCETTA STRINGI TUBO ZINCATA</td> <td>3</td> <td>PZ</td> </tr> <tr> <td>TB1520A0</td> <td>TUBO D.INT=30 SP=4 GOMMA EPDM NERO</td> <td>0.170</td> <td>M</td> </tr> <tr> <td>VE1140A0</td> <td>ATTUATORE VENTURI 200V 60 HZ SERIE 2</td> <td>1</td> <td>PZ</td> </tr> <tr> <td>VI1032A0</td> <td>VITE M4X16 TCB+ INOX</td> <td>1</td> <td>PZ</td> </tr> <tr> <td>VI1220A1</td> <td>VITE AUTOFILETTA NTE 4.2X11 TCS+ MARUTE</td> <td>6</td> <td>PZ</td> </tr> </tbody> </table>	Codice	Descrizione	Qtà	UM	GN1556A0	GUARNIZIONE VENTURI MM	1	PZ	RC1378A0	FASCETTA STRINGI TUBO ZINCATA	3	PZ	TB1520A0	TUBO D.INT=30 SP=4 GOMMA EPDM NERO	0.170	M	VE1140A0	ATTUATORE VENTURI 200V 60 HZ SERIE 2	1	PZ	VI1032A0	VITE M4X16 TCB+ INOX	1	PZ	VI1220A1	VITE AUTOFILETTA NTE 4.2X11 TCS+ MARUTE	6	PZ																				
Codice	Descrizione	Qtà	UM																																																		
GN1556A0	GUARNIZIONE VENTURI MM	1	PZ																																																		
RC1378A0	FASCETTA STRINGI TUBO ZINCATA	3	PZ																																																		
TB1520A0	TUBO D.INT=30 SP=4 GOMMA EPDM NERO	0.170	M																																																		
VE1140A0	ATTUATORE VENTURI 200V 60 HZ SERIE 2	1	PZ																																																		
VI1032A0	VITE M4X16 TCB+ INOX	1	PZ																																																		
VI1220A1	VITE AUTOFILETTA NTE 4.2X11 TCS+ MARUTE	6	PZ																																																		

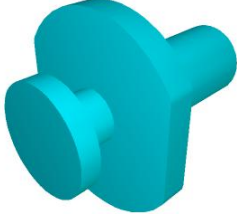

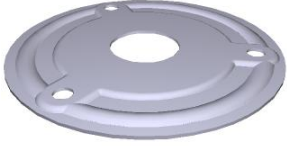

COMPONENTE			RICAMBIO																																										
Codice	Descrizione	Immagine	Codice	Descrizione	Lista componenti																																								
VM2379A	ASM BOBINA VENTURI 200V 50/60 HZ		KVM2379A	KIT ASSIEME ATTUATORE VENTURI MM	<table border="1"> <thead> <tr> <th>Codice</th> <th>Descrizione</th> <th>Qtà</th> <th>UM</th> </tr> </thead> <tbody> <tr> <td>VM2345A0</td> <td>CORPO SUPERIORE VENTURI MM</td> <td>1</td> <td>PZ</td> </tr> <tr> <td>VM2346A0</td> <td>CORPO INFERIORE VENTURI MM</td> <td>1</td> <td>PZ</td> </tr> <tr> <td>VM2347A0</td> <td>COPERCHIETT O VENTURI MIND.MAPS</td> <td>1</td> <td>PZ</td> </tr> <tr> <td>VM2348A0</td> <td>DISTANZIALE PIATTELLO VENTURI</td> <td>1</td> <td>PZ</td> </tr> <tr> <td>VM2349A0</td> <td>BOCCOLA INFERIORE VENTURI</td> <td>1</td> <td>PZ</td> </tr> </tbody> </table>	Codice	Descrizione	Qtà	UM	VM2345A0	CORPO SUPERIORE VENTURI MM	1	PZ	VM2346A0	CORPO INFERIORE VENTURI MM	1	PZ	VM2347A0	COPERCHIETT O VENTURI MIND.MAPS	1	PZ	VM2348A0	DISTANZIALE PIATTELLO VENTURI	1	PZ	VM2349A0	BOCCOLA INFERIORE VENTURI	1	PZ																
Codice	Descrizione	Qtà	UM																																										
VM2345A0	CORPO SUPERIORE VENTURI MM	1	PZ																																										
VM2346A0	CORPO INFERIORE VENTURI MM	1	PZ																																										
VM2347A0	COPERCHIETT O VENTURI MIND.MAPS	1	PZ																																										
VM2348A0	DISTANZIALE PIATTELLO VENTURI	1	PZ																																										
VM2349A0	BOCCOLA INFERIORE VENTURI	1	PZ																																										
GN1584A	RACCORDO ANGOLARE D30-D16		KG1584A	KIT RACCORDO ANGOLARE D30-D16	<table border="1"> <thead> <tr> <th>Codice</th> <th>Descrizione</th> <th>Qtà</th> <th>UM</th> </tr> </thead> <tbody> <tr> <td>GN1584A0</td> <td>RACCORDO ANGOLARE D30-D16</td> <td>1</td> <td>PZ</td> </tr> </tbody> </table>	Codice	Descrizione	Qtà	UM	GN1584A0	RACCORDO ANGOLARE D30-D16	1	PZ																																
Codice	Descrizione	Qtà	UM																																										
GN1584A0	RACCORDO ANGOLARE D30-D16	1	PZ																																										
TB1956A	TB1520A-TUBO GRIGIO SILICONE L=0,04M		KVE1135A	KIT RICAMBIO VENTURI FORNI SERIE 5/E	<table border="1"> <thead> <tr> <th>Codice</th> <th>Descrizione</th> <th>Qtà</th> <th>UM</th> </tr> </thead> <tbody> <tr> <td>GN1310A0</td> <td>GUARNIZIONE PIATTELLO VENTURI SILICONE</td> <td>1</td> <td>PZ</td> </tr> <tr> <td>GN1556A0</td> <td>GUARNIZIONE VENTURI MM</td> <td>1</td> <td>PZ</td> </tr> <tr> <td>RC1378A0</td> <td>FASCETTA STRINGI TUBO ZINCATA</td> <td>2</td> <td>PZ</td> </tr> <tr> <td>TB1520A0</td> <td>TUBO D.INT=30 SP=4 GOMMA EPDM NERO</td> <td>0.050</td> <td>M</td> </tr> <tr> <td>VE1135A0</td> <td>ATTUATORE VENTURI 220V 50/60 HZ SERIE 2</td> <td>1</td> <td>PZ</td> </tr> <tr> <td>VI1032A0</td> <td>VITE M4X16 TCB+ INOX</td> <td>1</td> <td>PZ</td> </tr> <tr> <td>VI1511A0</td> <td>RONDELLA PIANA 4.2X12X1 INOX</td> <td>2</td> <td>PZ</td> </tr> <tr> <td>VI1850A0</td> <td>VITE M4X6 TCB+ NICHELATA</td> <td>2</td> <td>PZ</td> </tr> <tr> <td>VI1865A0</td> <td>VITE AUTOFIL. 5X10 TCB+</td> <td>3</td> <td>PZ</td> </tr> </tbody> </table>	Codice	Descrizione	Qtà	UM	GN1310A0	GUARNIZIONE PIATTELLO VENTURI SILICONE	1	PZ	GN1556A0	GUARNIZIONE VENTURI MM	1	PZ	RC1378A0	FASCETTA STRINGI TUBO ZINCATA	2	PZ	TB1520A0	TUBO D.INT=30 SP=4 GOMMA EPDM NERO	0.050	M	VE1135A0	ATTUATORE VENTURI 220V 50/60 HZ SERIE 2	1	PZ	VI1032A0	VITE M4X16 TCB+ INOX	1	PZ	VI1511A0	RONDELLA PIANA 4.2X12X1 INOX	2	PZ	VI1850A0	VITE M4X6 TCB+ NICHELATA	2	PZ	VI1865A0	VITE AUTOFIL. 5X10 TCB+	3	PZ
Codice	Descrizione	Qtà	UM																																										
GN1310A0	GUARNIZIONE PIATTELLO VENTURI SILICONE	1	PZ																																										
GN1556A0	GUARNIZIONE VENTURI MM	1	PZ																																										
RC1378A0	FASCETTA STRINGI TUBO ZINCATA	2	PZ																																										
TB1520A0	TUBO D.INT=30 SP=4 GOMMA EPDM NERO	0.050	M																																										
VE1135A0	ATTUATORE VENTURI 220V 50/60 HZ SERIE 2	1	PZ																																										
VI1032A0	VITE M4X16 TCB+ INOX	1	PZ																																										
VI1511A0	RONDELLA PIANA 4.2X12X1 INOX	2	PZ																																										
VI1850A0	VITE M4X6 TCB+ NICHELATA	2	PZ																																										
VI1865A0	VITE AUTOFIL. 5X10 TCB+	3	PZ																																										

COMPONENTE			RICAMBIO										
Codice	Descrizione	Immagine	Codice	Descrizione	Lista componenti								
TB1956A	TB1520A-TUBO GRIGIO SILICONE L=0,04M		KVE1135A	KIT RICAMBIO VENTURI FORNI SERIE 5/E	<table border="1"> <thead> <tr> <th>Codice</th> <th>Descrizione</th> <th>Qtà</th> <th>UM</th> </tr> </thead> <tbody> <tr> <td>VM1565B0</td> <td>PORTA BOBINA INFERIORE VENTURI CT B</td> <td>1</td> <td>PZ</td> </tr> </tbody> </table>	Codice	Descrizione	Qtà	UM	VM1565B0	PORTA BOBINA INFERIORE VENTURI CT B	1	PZ
					Codice	Descrizione	Qtà	UM					
					VM1565B0	PORTA BOBINA INFERIORE VENTURI CT B	1	PZ					
					<table border="1"> <thead> <tr> <th>Codice</th> <th>Descrizione</th> <th>Qtà</th> <th>UM</th> </tr> </thead> <tbody> <tr> <td>VM1566A0</td> <td>PORTA BOBINA SUPERIORE VENTURI</td> <td>1</td> <td>PZ</td> </tr> </tbody> </table>	Codice	Descrizione	Qtà	UM	VM1566A0	PORTA BOBINA SUPERIORE VENTURI	1	PZ
			Codice	Descrizione	Qtà	UM							
			VM1566A0	PORTA BOBINA SUPERIORE VENTURI	1	PZ							
			<table border="1"> <thead> <tr> <th>Codice</th> <th>Descrizione</th> <th>Qtà</th> <th>UM</th> </tr> </thead> <tbody> <tr> <td>VM1567A0</td> <td>BOCCOLA INFERIORE VENTURI</td> <td>1</td> <td>PZ</td> </tr> </tbody> </table>	Codice	Descrizione	Qtà	UM	VM1567A0	BOCCOLA INFERIORE VENTURI	1	PZ		
			Codice	Descrizione	Qtà	UM							
			VM1567A0	BOCCOLA INFERIORE VENTURI	1	PZ							
			<table border="1"> <thead> <tr> <th>Codice</th> <th>Descrizione</th> <th>Qtà</th> <th>UM</th> </tr> </thead> <tbody> <tr> <td>VM1568A0</td> <td>DISTANZIALE PIATTELLO VENTURI</td> <td>1</td> <td>PZ</td> </tr> </tbody> </table>	Codice	Descrizione	Qtà	UM	VM1568A0	DISTANZIALE PIATTELLO VENTURI	1	PZ		
			Codice	Descrizione	Qtà	UM							
			VM1568A0	DISTANZIALE PIATTELLO VENTURI	1	PZ							
KTB1002A	KIT TUBO EPDM NERO 60MT TB1520	<table border="1"> <thead> <tr> <th>Codice</th> <th>Descrizione</th> <th>Qtà</th> <th>UM</th> </tr> </thead> <tbody> <tr> <td>IL1206C0</td> <td>PALETTA LEGNO 968X1053 H126 XBC</td> <td>1</td> <td>PZ</td> </tr> </tbody> </table>	Codice	Descrizione	Qtà	UM	IL1206C0	PALETTA LEGNO 968X1053 H126 XBC	1	PZ			
		Codice	Descrizione	Qtà	UM								
		IL1206C0	PALETTA LEGNO 968X1053 H126 XBC	1	PZ								
<table border="1"> <thead> <tr> <th>Codice</th> <th>Descrizione</th> <th>Qtà</th> <th>UM</th> </tr> </thead> <tbody> <tr> <td>TB1520A0</td> <td>TUBO D.INT=30 SP=4 GOMMA EPDM NERO</td> <td>60</td> <td>M</td> </tr> </tbody> </table>	Codice	Descrizione	Qtà	UM	TB1520A0	TUBO D.INT=30 SP=4 GOMMA EPDM NERO	60	M					
Codice	Descrizione	Qtà	UM										
TB1520A0	TUBO D.INT=30 SP=4 GOMMA EPDM NERO	60	M										
<table border="1"> <thead> <tr> <th>Codice</th> <th>Descrizione</th> <th>Qtà</th> <th>UM</th> </tr> </thead> <tbody> <tr> <td>TB1520A0</td> <td>TUBO D.INT=30 SP=4 GOMMA EPDM NERO</td> <td>10</td> <td>M</td> </tr> </tbody> </table>	Codice	Descrizione	Qtà	UM	TB1520A0	TUBO D.INT=30 SP=4 GOMMA EPDM NERO	10	M					
Codice	Descrizione	Qtà	UM										
TB1520A0	TUBO D.INT=30 SP=4 GOMMA EPDM NERO	10	M										
KTB1001A	KIT TUBO EPDM NERO 10MT TB1520	<table border="1"> <thead> <tr> <th>Codice</th> <th>Descrizione</th> <th>Qtà</th> <th>UM</th> </tr> </thead> <tbody> <tr> <td>VM1794A0</td> <td>FASCETTA 250X4.8 PA66 NERA</td> <td>3</td> <td>PZ</td> </tr> </tbody> </table>	Codice	Descrizione	Qtà	UM	VM1794A0	FASCETTA 250X4.8 PA66 NERA	3	PZ			
		Codice	Descrizione	Qtà	UM								
VM1794A0	FASCETTA 250X4.8 PA66 NERA	3	PZ										
<table border="1"> <thead> <tr> <th>Codice</th> <th>Descrizione</th> <th>Qtà</th> <th>UM</th> </tr> </thead> <tbody> <tr> <td>RC1055A0</td> <td>FASCETTA STRINGI TUBO Ø25-40 H12 INOX</td> <td>2</td> <td>PZ</td> </tr> </tbody> </table>	Codice	Descrizione	Qtà	UM	RC1055A0	FASCETTA STRINGI TUBO Ø25-40 H12 INOX	2	PZ					
Codice	Descrizione	Qtà	UM										
RC1055A0	FASCETTA STRINGI TUBO Ø25-40 H12 INOX	2	PZ										
KTB1000A	KIT TUBO EPDM NERO 2MT TB1520A	<table border="1"> <thead> <tr> <th>Codice</th> <th>Descrizione</th> <th>Qtà</th> <th>UM</th> </tr> </thead> <tbody> <tr> <td>TB1520A0</td> <td>TUBO D.INT=30 SP=4 GOMMA EPDM NERO</td> <td>2</td> <td>M</td> </tr> </tbody> </table>	Codice	Descrizione	Qtà	UM	TB1520A0	TUBO D.INT=30 SP=4 GOMMA EPDM NERO	2	M			
		Codice	Descrizione	Qtà	UM								
		TB1520A0	TUBO D.INT=30 SP=4 GOMMA EPDM NERO	2	M								
<table border="1"> <thead> <tr> <th>Codice</th> <th>Descrizione</th> <th>Qtà</th> <th>UM</th> </tr> </thead> <tbody> <tr> <td>VM1059A1</td> <td>FILM TERMORETRA IBILE H800</td> <td>0.500</td> <td>M</td> </tr> </tbody> </table>	Codice	Descrizione	Qtà	UM	VM1059A1	FILM TERMORETRA IBILE H800	0.500	M					
Codice	Descrizione	Qtà	UM										
VM1059A1	FILM TERMORETRA IBILE H800	0.500	M										

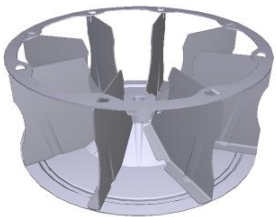

COMPONENTE			RICAMBIO																										
Codice	Descrizione	Immagine	Codice	Descrizione	Lista componenti																								
RC1042A	FASCETTA BIFILARE A MOLLA D21.5-22.6 TUB		RC1042A0	FASCETTA BIFILARE A MOLLA D21.5-22.6 TUB																									
TB2957B	TUBO VENTURI XEVC-0511-E		KTB2957B	KIT TUBO COLLETTORE VENTURI 0511/04EU-E	<table border="1"> <thead> <tr> <th>Codice</th> <th>Descrizione</th> <th>Qtà</th> <th>UM</th> </tr> </thead> <tbody> <tr> <td>GN1544A0</td> <td>GUARNIZIONE INGRESSO ARI</td> <td>1</td> <td>PZ</td> </tr> <tr> <td>GN1584A0</td> <td>RACCORDO ANGOLARE D30-D16</td> <td>1</td> <td>PZ</td> </tr> <tr> <td>RC1042A0</td> <td>FASCETTA BIFILARE A MOLLA D21.5-22.6 TUB</td> <td>1</td> <td>PZ</td> </tr> <tr> <td>TB2957B0</td> <td>TUBO VENTURI XEVC-0511-E</td> <td>1</td> <td>PZ</td> </tr> <tr> <td>VM1794A0</td> <td>FASCETTA 250X4.8 PA66 NERA</td> <td>1</td> <td>PZ</td> </tr> </tbody> </table>	Codice	Descrizione	Qtà	UM	GN1544A0	GUARNIZIONE INGRESSO ARI	1	PZ	GN1584A0	RACCORDO ANGOLARE D30-D16	1	PZ	RC1042A0	FASCETTA BIFILARE A MOLLA D21.5-22.6 TUB	1	PZ	TB2957B0	TUBO VENTURI XEVC-0511-E	1	PZ	VM1794A0	FASCETTA 250X4.8 PA66 NERA	1	PZ
Codice	Descrizione	Qtà	UM																										
GN1544A0	GUARNIZIONE INGRESSO ARI	1	PZ																										
GN1584A0	RACCORDO ANGOLARE D30-D16	1	PZ																										
RC1042A0	FASCETTA BIFILARE A MOLLA D21.5-22.6 TUB	1	PZ																										
TB2957B0	TUBO VENTURI XEVC-0511-E	1	PZ																										
VM1794A0	FASCETTA 250X4.8 PA66 NERA	1	PZ																										
PE1710B	SENSORE GIRI E VERSO ROTAZIONE MOTORE		KPE1710B	KIT SENSORE NUMERO GIRI MOTORE	<table border="1"> <thead> <tr> <th>Codice</th> <th>Descrizione</th> <th>Qtà</th> <th>UM</th> </tr> </thead> <tbody> <tr> <td>PE1710B0</td> <td>SENSORE GIRI E VERSO ROTAZIONE MOTORE</td> <td>1</td> <td>PZ</td> </tr> <tr> <td>VE1550A0</td> <td>MAGNETE NEODIMIO 5X3 MM</td> <td>1</td> <td>PZ</td> </tr> <tr> <td>VI1966A0</td> <td>VITE M4X14 TSP+ ZN</td> <td>1</td> <td>PZ</td> </tr> <tr> <td>VM1635A0</td> <td>DISCO SUPPORTO MAGNETE</td> <td>1</td> <td>PZ</td> </tr> </tbody> </table>	Codice	Descrizione	Qtà	UM	PE1710B0	SENSORE GIRI E VERSO ROTAZIONE MOTORE	1	PZ	VE1550A0	MAGNETE NEODIMIO 5X3 MM	1	PZ	VI1966A0	VITE M4X14 TSP+ ZN	1	PZ	VM1635A0	DISCO SUPPORTO MAGNETE	1	PZ				
Codice	Descrizione	Qtà	UM																										
PE1710B0	SENSORE GIRI E VERSO ROTAZIONE MOTORE	1	PZ																										
VE1550A0	MAGNETE NEODIMIO 5X3 MM	1	PZ																										
VI1966A0	VITE M4X14 TSP+ ZN	1	PZ																										
VM1635A0	DISCO SUPPORTO MAGNETE	1	PZ																										
VE1550A	MAGNETE NEODIMIO 5X3 MM		VE1550A0	MAGNETE NEODIMIO 5X3 MM																									

COMPONENTE			RICAMBIO																																										
Codice	Descrizione	Immagine	Codice	Descrizione	Lista componenti																																								
GN1588A	GUARNIZIONE RESISTENZA 78X28 G6.25		GN1588A0	GUARNIZIONE RESISTENZA 78X28 G6.25																																									
VM2416A	PERNO GUIDA BLOCCA SMOKER		VM2416A0	PERNO GUIDA BLOCCA SMOKER																																									
MT1012A	MOTORE SIMMETRICO 330W 230V ALBERO D12		KMT1012A	KIT MOTORE 330W 230V ALBERO D12	<table border="1"> <thead> <tr> <th>Codice</th> <th>Descrizione</th> <th>Q.tà</th> <th>UM</th> </tr> </thead> <tbody> <tr> <td>GN1140A2</td> <td>GUARNIZIONE PORTAMOTO RE STAMPAT</td> <td>1</td> <td>PZ</td> </tr> <tr> <td>MT1012A0</td> <td>MOTORE SIMMETRICO 330W 230V ALBERO D12</td> <td>1</td> <td>PZ</td> </tr> <tr> <td>VE1550A0</td> <td>MAGNETE NEODIMIO 5X3 MM</td> <td>1</td> <td>PZ</td> </tr> <tr> <td>VI1077A1</td> <td>VITE M6X12 TE INOX</td> <td>1</td> <td>PZ</td> </tr> <tr> <td>VI1521A0</td> <td>RONDELLA PIANA 6X12X1 INOX</td> <td>1</td> <td>PZ</td> </tr> <tr> <td>VI1966A0</td> <td>VITE M4X14 TSP+ ZN</td> <td>1</td> <td>PZ</td> </tr> <tr> <td>VM1635A0</td> <td>DISCO SUPPORTO MAGNETE</td> <td>1</td> <td>PZ</td> </tr> <tr> <td>VM1794A0</td> <td>FASCETTA 250X4.8 PA66 NERA</td> <td>4</td> <td>PZ</td> </tr> <tr> <td>VM2103A0</td> <td>PIASTRINA FERMAFASCE TTA</td> <td>4</td> <td>PZ</td> </tr> </tbody> </table>	Codice	Descrizione	Q.tà	UM	GN1140A2	GUARNIZIONE PORTAMOTO RE STAMPAT	1	PZ	MT1012A0	MOTORE SIMMETRICO 330W 230V ALBERO D12	1	PZ	VE1550A0	MAGNETE NEODIMIO 5X3 MM	1	PZ	VI1077A1	VITE M6X12 TE INOX	1	PZ	VI1521A0	RONDELLA PIANA 6X12X1 INOX	1	PZ	VI1966A0	VITE M4X14 TSP+ ZN	1	PZ	VM1635A0	DISCO SUPPORTO MAGNETE	1	PZ	VM1794A0	FASCETTA 250X4.8 PA66 NERA	4	PZ	VM2103A0	PIASTRINA FERMAFASCE TTA	4	PZ
Codice	Descrizione	Q.tà	UM																																										
GN1140A2	GUARNIZIONE PORTAMOTO RE STAMPAT	1	PZ																																										
MT1012A0	MOTORE SIMMETRICO 330W 230V ALBERO D12	1	PZ																																										
VE1550A0	MAGNETE NEODIMIO 5X3 MM	1	PZ																																										
VI1077A1	VITE M6X12 TE INOX	1	PZ																																										
VI1521A0	RONDELLA PIANA 6X12X1 INOX	1	PZ																																										
VI1966A0	VITE M4X14 TSP+ ZN	1	PZ																																										
VM1635A0	DISCO SUPPORTO MAGNETE	1	PZ																																										
VM1794A0	FASCETTA 250X4.8 PA66 NERA	4	PZ																																										
VM2103A0	PIASTRINA FERMAFASCE TTA	4	PZ																																										

COMPONENTE			RICAMBIO																						
Codice	Descrizione	Immagine	Codice	Descrizione	Lista componenti																				
0H7170A	PREMI LANA DI VETRO MOTORE M		0H7170A0	PREMI LANA DI VETRO MOTORE M																					
GN1140A	GUARNIZIONE PORTAMOTORE STAMPATO		KGN1140A	KIT 5 PZ.GUARNIZIONE PORTAMOTORE	<table border="1"> <thead> <tr> <th>Codice</th> <th>Descrizione</th> <th>Qtà</th> <th>UM</th> </tr> </thead> <tbody> <tr> <td>GN1140A2</td> <td>GUARNIZIONE PORTAMOTO RE STAMPAT</td> <td>5</td> <td>PZ</td> </tr> </tbody> </table>	Codice	Descrizione	Qtà	UM	GN1140A2	GUARNIZIONE PORTAMOTO RE STAMPAT	5	PZ												
Codice	Descrizione	Qtà	UM																						
GN1140A2	GUARNIZIONE PORTAMOTO RE STAMPAT	5	PZ																						
0H4305A	DISCO TENUTA ALBERO MOTORE INOX STP		K0H4305A	KIT DISCO TENUTA 0H4305A	<table border="1"> <thead> <tr> <th>Codice</th> <th>Descrizione</th> <th>Qtà</th> <th>UM</th> </tr> </thead> <tbody> <tr> <td>0H4305A1</td> <td>DISCO TENUTA ALBERO MOTORE INOX STP</td> <td>1</td> <td>PZ</td> </tr> <tr> <td>GN1140A2</td> <td>GUARNIZIONE PORTAMOTO RE STAMPAT</td> <td>1</td> <td>PZ</td> </tr> <tr> <td>SL1045A0</td> <td>SILICONE ANTRACITE S53 80 ML</td> <td>1</td> <td>PZ</td> </tr> <tr> <td>VI1220A1</td> <td>VITE AUTOFILETTA NTE 4.2X11 TCS+ MARUTE</td> <td>3</td> <td>PZ</td> </tr> </tbody> </table>	Codice	Descrizione	Qtà	UM	0H4305A1	DISCO TENUTA ALBERO MOTORE INOX STP	1	PZ	GN1140A2	GUARNIZIONE PORTAMOTO RE STAMPAT	1	PZ	SL1045A0	SILICONE ANTRACITE S53 80 ML	1	PZ	VI1220A1	VITE AUTOFILETTA NTE 4.2X11 TCS+ MARUTE	3	PZ
Codice	Descrizione	Qtà	UM																						
0H4305A1	DISCO TENUTA ALBERO MOTORE INOX STP	1	PZ																						
GN1140A2	GUARNIZIONE PORTAMOTO RE STAMPAT	1	PZ																						
SL1045A0	SILICONE ANTRACITE S53 80 ML	1	PZ																						
VI1220A1	VITE AUTOFILETTA NTE 4.2X11 TCS+ MARUTE	3	PZ																						
0H7663A	PREMI LANA DI VETRO MOTORE S.6 MV																								

COMPONENTE			RICAMBIO																														
Codice	Descrizione	Immagine	Codice	Descrizione	Lista componenti																												
VN1170B	VENTOLA D195 H80 8 PALE DADO M8 + ANELLO		KVN1170B	KIT VENTOLA D195 H80 8 PALE DADO M8+ANEL	<table border="1"> <thead> <tr> <th>Codice</th> <th>Descrizione</th> <th>Qtà</th> <th>UM</th> </tr> </thead> <tbody> <tr> <td>V11077A1</td> <td>VITE M6X12 TE INOX</td> <td>1</td> <td>PZ</td> </tr> <tr> <td>V11521A0</td> <td>RONDELLA PIANA 6X12X1 INOX</td> <td>1</td> <td>PZ</td> </tr> <tr> <td>VN1170B0</td> <td>VENTOLA D195 H80 8 PALE DADO M8 + ANELLO</td> <td>1</td> <td>PZ</td> </tr> </tbody> </table>	Codice	Descrizione	Qtà	UM	V11077A1	VITE M6X12 TE INOX	1	PZ	V11521A0	RONDELLA PIANA 6X12X1 INOX	1	PZ	VN1170B0	VENTOLA D195 H80 8 PALE DADO M8 + ANELLO	1	PZ												
Codice	Descrizione	Qtà	UM																														
V11077A1	VITE M6X12 TE INOX	1	PZ																														
V11521A0	RONDELLA PIANA 6X12X1 INOX	1	PZ																														
VN1170B0	VENTOLA D195 H80 8 PALE DADO M8 + ANELLO	1	PZ																														
TB2951A	TUBO INTERNO UMIDITA XEVC-0511-E		TB2951A0	TUBO INTERNO UMIDITA XEVC-0511-E																													
0G1549B	CARTER COMPLETO CON ALETTE XEVC-0511-		0G1549B0	CARTER COMPLETO CON ALETTE XEVC-0511-																													
GRL1390A	SUPPORTO LAT. SX 5 GN1/1 0511		KGRL1390A	KIT SUPPORTI LATERALI 5 GN1/1 0511	<table border="1"> <thead> <tr> <th>Codice</th> <th>Descrizione</th> <th>Qtà</th> <th>UM</th> </tr> </thead> <tbody> <tr> <td>0H4030A0</td> <td>PROFILO GUIDA TEGLIE GASTRONOMI A L287</td> <td>10</td> <td>PZ</td> </tr> <tr> <td>0H4420A0</td> <td>PIASTRINA SUPPORTO SONDA AL CUORE H35</td> <td>1</td> <td>PZ</td> </tr> <tr> <td>0H7300A0</td> <td>PROFILO PIANO PER SUPP 0H7308 0H7309</td> <td>2</td> <td>PZ</td> </tr> <tr> <td>0H7301A0</td> <td>PROFILO PIANO PER SUPP 0H7310 0H7311</td> <td>2</td> <td>PZ</td> </tr> <tr> <td>0H7797A0</td> <td>PROFILO GUIDA TEGLIE GN 1/1 L287 ASOLATO</td> <td>10</td> <td>PZ</td> </tr> <tr> <td>IP1508A0</td> <td>POLISTIROLO PROFILO AD U 2000X60X60</td> <td>2</td> <td>PZ</td> </tr> </tbody> </table>	Codice	Descrizione	Qtà	UM	0H4030A0	PROFILO GUIDA TEGLIE GASTRONOMI A L287	10	PZ	0H4420A0	PIASTRINA SUPPORTO SONDA AL CUORE H35	1	PZ	0H7300A0	PROFILO PIANO PER SUPP 0H7308 0H7309	2	PZ	0H7301A0	PROFILO PIANO PER SUPP 0H7310 0H7311	2	PZ	0H7797A0	PROFILO GUIDA TEGLIE GN 1/1 L287 ASOLATO	10	PZ	IP1508A0	POLISTIROLO PROFILO AD U 2000X60X60	2	PZ
Codice	Descrizione	Qtà	UM																														
0H4030A0	PROFILO GUIDA TEGLIE GASTRONOMI A L287	10	PZ																														
0H4420A0	PIASTRINA SUPPORTO SONDA AL CUORE H35	1	PZ																														
0H7300A0	PROFILO PIANO PER SUPP 0H7308 0H7309	2	PZ																														
0H7301A0	PROFILO PIANO PER SUPP 0H7310 0H7311	2	PZ																														
0H7797A0	PROFILO GUIDA TEGLIE GN 1/1 L287 ASOLATO	10	PZ																														
IP1508A0	POLISTIROLO PROFILO AD U 2000X60X60	2	PZ																														



COMPONENTE			RICAMBIO																																						
Codice	Descrizione	Immagine	Codice	Descrizione	Lista componenti																																				
GRL1390A	SUPPORTO LAT. SX 5 GN1/1 0511		KGRL1390A	KIT SUPPORTI LATERALI 5 GN1/1 0511	<table border="1"> <thead> <tr> <th>Codice</th> <th>Descrizione</th> <th>Qtà</th> <th>UM</th> </tr> </thead> <tbody> <tr> <td>IP1508A1</td> <td>POLISTIROLO PROFILO AD U 2000X60X60</td> <td>2</td> <td>M</td> </tr> <tr> <td>VM1059A1</td> <td>FILM TERMORETRA IBILE H800</td> <td>1.500</td> <td>M</td> </tr> </tbody> </table>	Codice	Descrizione	Qtà	UM	IP1508A1	POLISTIROLO PROFILO AD U 2000X60X60	2	M	VM1059A1	FILM TERMORETRA IBILE H800	1.500	M																								
Codice	Descrizione	Qtà	UM																																						
IP1508A1	POLISTIROLO PROFILO AD U 2000X60X60	2	M																																						
VM1059A1	FILM TERMORETRA IBILE H800	1.500	M																																						
GRL1389A	SUPPORTO LAT. DX 5 GN1/1 0511		KGRL1390A	KIT SUPPORTI LATERALI 5 GN1/1 0511	<table border="1"> <thead> <tr> <th>Codice</th> <th>Descrizione</th> <th>Qtà</th> <th>UM</th> </tr> </thead> <tbody> <tr> <td>0H4030A0</td> <td>PROFILO GUIDA TEGLIE GASTRONOMI A L287</td> <td>10</td> <td>PZ</td> </tr> <tr> <td>0H4420A0</td> <td>PIASTRINA SUPPORTO SONDA AL CUORE H35</td> <td>1</td> <td>PZ</td> </tr> <tr> <td>0H7300A0</td> <td>PROFILO PIANO PER SUPP 0H7308 0H7309</td> <td>2</td> <td>PZ</td> </tr> <tr> <td>0H7301A0</td> <td>PROFILO PIANO PER SUPP 0H7310 0H7311</td> <td>2</td> <td>PZ</td> </tr> <tr> <td>0H7797A0</td> <td>PROFILO GUIDA TEGLIE GN 1/1 L287 ASOLATO</td> <td>10</td> <td>PZ</td> </tr> <tr> <td>IP1508A0</td> <td>POLISTIROLO PROFILO AD U 2000X60X60</td> <td>2</td> <td>PZ</td> </tr> <tr> <td>IP1508A1</td> <td>POLISTIROLO PROFILO AD U 2000X60X60</td> <td>2</td> <td>M</td> </tr> <tr> <td>VM1059A1</td> <td>FILM TERMORETRA IBILE H800</td> <td>1.500</td> <td>M</td> </tr> </tbody> </table>	Codice	Descrizione	Qtà	UM	0H4030A0	PROFILO GUIDA TEGLIE GASTRONOMI A L287	10	PZ	0H4420A0	PIASTRINA SUPPORTO SONDA AL CUORE H35	1	PZ	0H7300A0	PROFILO PIANO PER SUPP 0H7308 0H7309	2	PZ	0H7301A0	PROFILO PIANO PER SUPP 0H7310 0H7311	2	PZ	0H7797A0	PROFILO GUIDA TEGLIE GN 1/1 L287 ASOLATO	10	PZ	IP1508A0	POLISTIROLO PROFILO AD U 2000X60X60	2	PZ	IP1508A1	POLISTIROLO PROFILO AD U 2000X60X60	2	M	VM1059A1	FILM TERMORETRA IBILE H800	1.500	M
Codice	Descrizione	Qtà	UM																																						
0H4030A0	PROFILO GUIDA TEGLIE GASTRONOMI A L287	10	PZ																																						
0H4420A0	PIASTRINA SUPPORTO SONDA AL CUORE H35	1	PZ																																						
0H7300A0	PROFILO PIANO PER SUPP 0H7308 0H7309	2	PZ																																						
0H7301A0	PROFILO PIANO PER SUPP 0H7310 0H7311	2	PZ																																						
0H7797A0	PROFILO GUIDA TEGLIE GN 1/1 L287 ASOLATO	10	PZ																																						
IP1508A0	POLISTIROLO PROFILO AD U 2000X60X60	2	PZ																																						
IP1508A1	POLISTIROLO PROFILO AD U 2000X60X60	2	M																																						
VM1059A1	FILM TERMORETRA IBILE H800	1.500	M																																						
TR1040A	SONDA CUORE STAMPATA L=1550		KTR1040A	KIT SONDA AL CUORE MONOPUNTO L=132	<table border="1"> <thead> <tr> <th>Codice</th> <th>Descrizione</th> <th>Qtà</th> <th>UM</th> </tr> </thead> <tbody> <tr> <td>0H7374A0</td> <td>LAMIERINO TAGLIO CAVO SONDA CUOR</td> <td>1</td> <td>PZ</td> </tr> <tr> <td>TR1040A2</td> <td>SONDA CUORE STAMPATA L1320</td> <td>1</td> <td>PZ</td> </tr> <tr> <td>TR1040A3</td> <td>SONDA CUORE STAMPATA L=1550</td> <td>1</td> <td>PZ</td> </tr> </tbody> </table>	Codice	Descrizione	Qtà	UM	0H7374A0	LAMIERINO TAGLIO CAVO SONDA CUOR	1	PZ	TR1040A2	SONDA CUORE STAMPATA L1320	1	PZ	TR1040A3	SONDA CUORE STAMPATA L=1550	1	PZ																				
Codice	Descrizione	Qtà	UM																																						
0H7374A0	LAMIERINO TAGLIO CAVO SONDA CUOR	1	PZ																																						
TR1040A2	SONDA CUORE STAMPATA L1320	1	PZ																																						
TR1040A3	SONDA CUORE STAMPATA L=1550	1	PZ																																						

COMPONENTE			RICAMBIO																						
Codice	Descrizione	Immagine	Codice	Descrizione	Lista componenti																				
RC1170A	DADO M14 H=8 CH=22 INOX		KRC1170A	KIT 10 DADI M14 H8 CH22 INOX	<table border="1"> <thead> <tr> <th>Codice</th> <th>Descrizione</th> <th>Qtà</th> <th>UM</th> </tr> </thead> <tbody> <tr> <td>RC1170A1</td> <td>DADO M14 H=8 CH=22 INOX</td> <td>10</td> <td>PZ</td> </tr> </tbody> </table>	Codice	Descrizione	Qtà	UM	RC1170A1	DADO M14 H=8 CH=22 INOX	10	PZ												
Codice	Descrizione	Qtà	UM																						
RC1170A1	DADO M14 H=8 CH=22 INOX	10	PZ																						
TB2937B	TUBO EST UMIDITA' D10 CON RACCORDO XEBC		TB2937B0	TUBO EST UMIDITA' D10 CON RACCORDO XEBC																					
GN1563A	GN1006A-GUARNIZI ONE PORTA 0511		KG1563A	KIT GUARNIZIONE PORTA 0511	<table border="1"> <thead> <tr> <th>Codice</th> <th>Descrizione</th> <th>Qtà</th> <th>UM</th> </tr> </thead> <tbody> <tr> <td>GN1006A1</td> <td>GUARNIZIONE FACCIATA PORTA BANDIERA</td> <td>2.240</td> <td>M</td> </tr> <tr> <td>GN1008A0</td> <td>GUARNIZIONE INTERNA PER GIUNZIONE GN1006</td> <td>0.030</td> <td>M</td> </tr> <tr> <td>SL1025A0</td> <td>TUBETTO SIL.90ML DOW CORNING 734 CLEAR</td> <td>0.012</td> <td>PZ</td> </tr> <tr> <td>VM2277A0</td> <td>SPINA KIT GUARNIZIONE PORTA</td> <td>1</td> <td>PZ</td> </tr> </tbody> </table>	Codice	Descrizione	Qtà	UM	GN1006A1	GUARNIZIONE FACCIATA PORTA BANDIERA	2.240	M	GN1008A0	GUARNIZIONE INTERNA PER GIUNZIONE GN1006	0.030	M	SL1025A0	TUBETTO SIL.90ML DOW CORNING 734 CLEAR	0.012	PZ	VM2277A0	SPINA KIT GUARNIZIONE PORTA	1	PZ
Codice	Descrizione	Qtà	UM																						
GN1006A1	GUARNIZIONE FACCIATA PORTA BANDIERA	2.240	M																						
GN1008A0	GUARNIZIONE INTERNA PER GIUNZIONE GN1006	0.030	M																						
SL1025A0	TUBETTO SIL.90ML DOW CORNING 734 CLEAR	0.012	PZ																						
VM2277A0	SPINA KIT GUARNIZIONE PORTA	1	PZ																						

**ASM2916A/0.D01 - Copertura esterna**

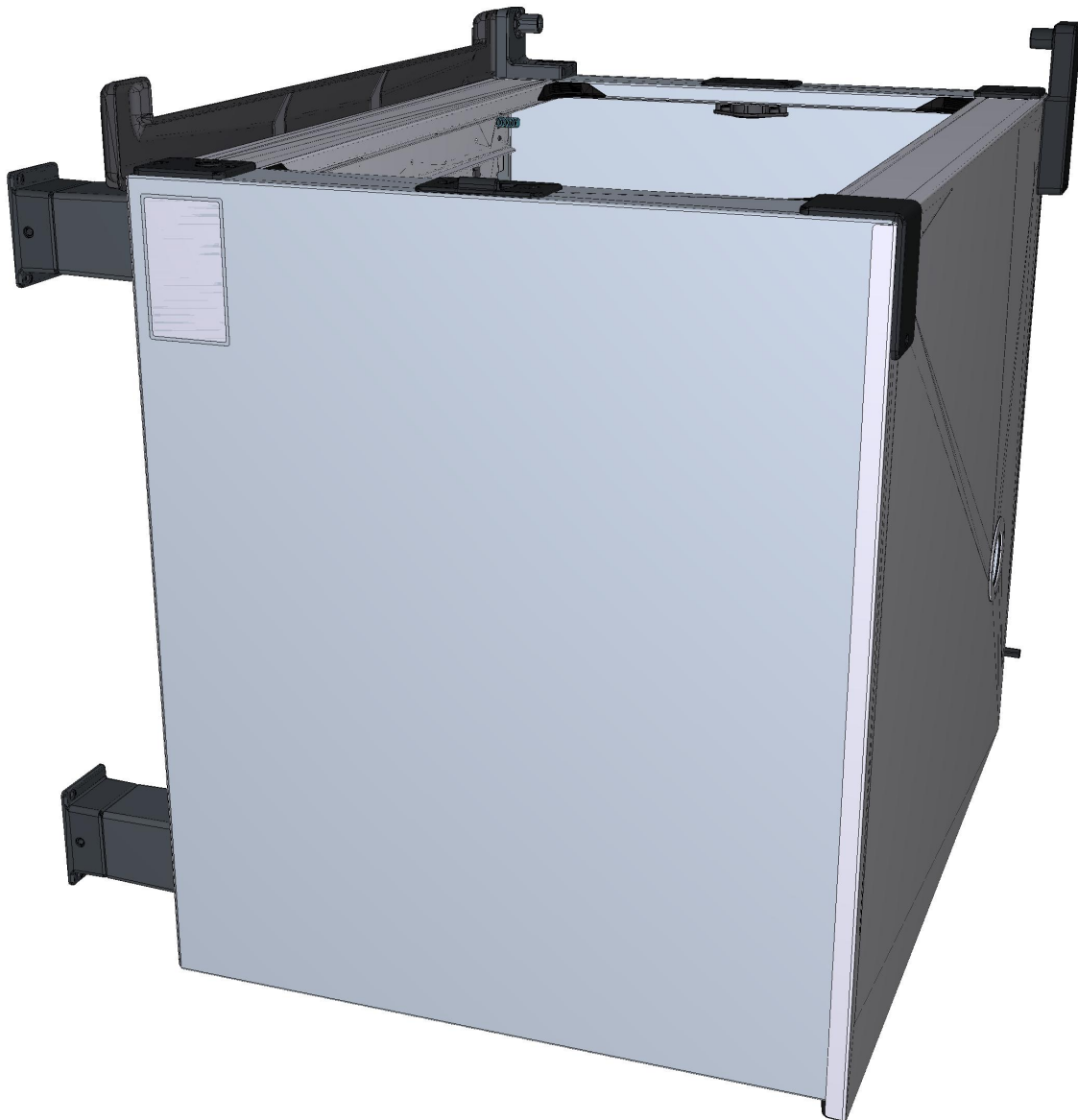

**FRONTE**





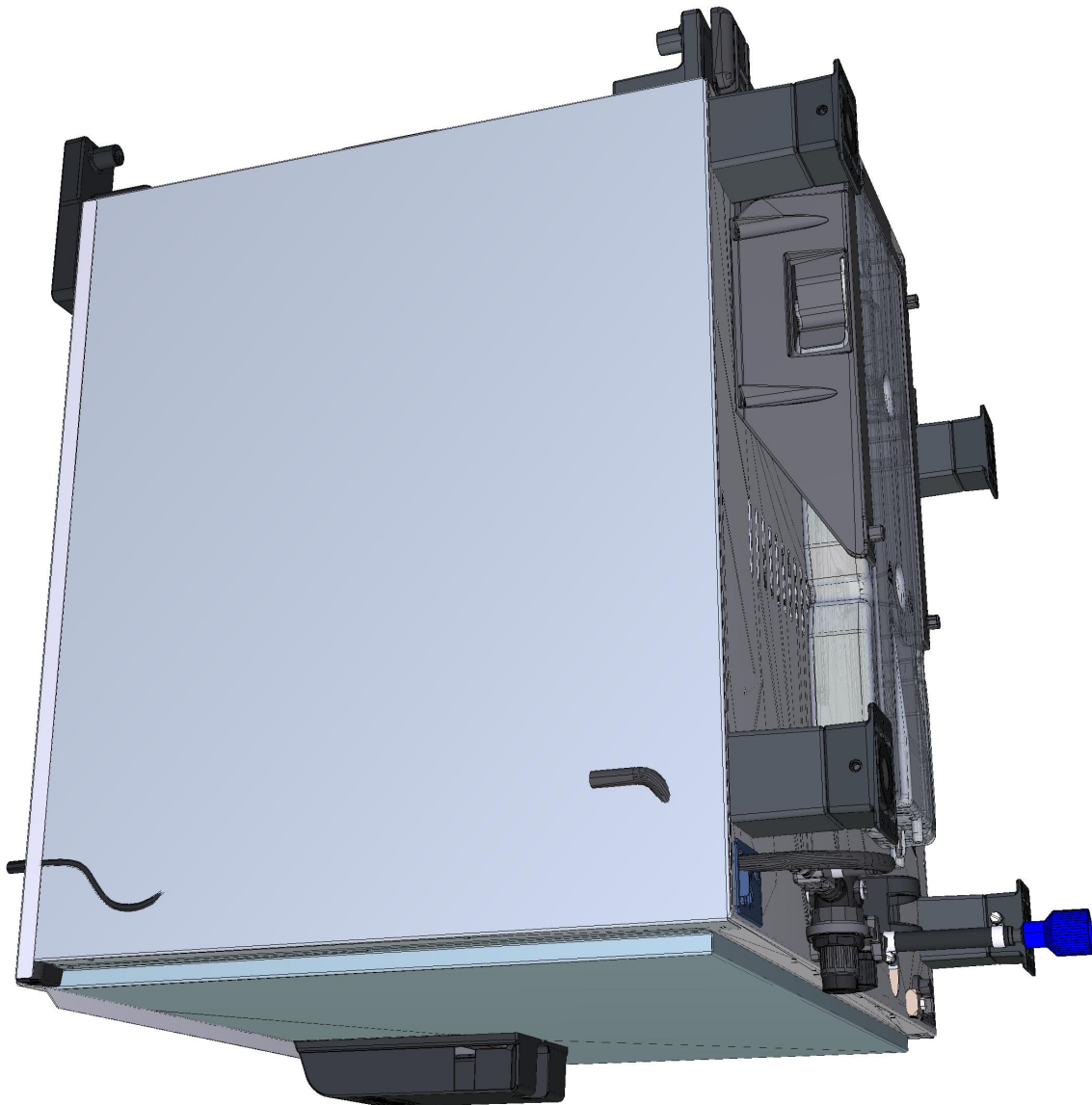

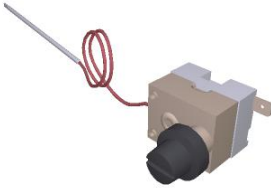
**ASM2916A/0.D01 - Copertura esterna**

**RETRO**



COMPONENTE			RICAMBIO																										
Codice	Descrizione	Immagine	Codice	Descrizione	Lista componenti																								
TR1136A	TERMOSTATO SIC. UNIP. 330°C		KTR1136A	KIT TERMOSTATO SICUREZZA 330°C	<table border="1"> <thead> <tr> <th>Codice</th> <th>Descrizione</th> <th>Qtà</th> <th>UM</th> </tr> </thead> <tbody> <tr> <td>0H7030A0</td> <td>COPERCHIO INGRESSO BULBO</td> <td>1</td> <td>PZ</td> </tr> <tr> <td>GN1531A0</td> <td>GUARNIZIONE TENUTA INGRESSO BULBO</td> <td>1</td> <td>PZ</td> </tr> <tr> <td>SL1045A0</td> <td>SILICONE ANTRACITE S53 80 ML</td> <td>1</td> <td>PZ</td> </tr> <tr> <td>TR1136A0</td> <td>TERMOSTATO SIC. UNIP. 330°C</td> <td>1</td> <td>PZ</td> </tr> <tr> <td>VI1220A1</td> <td>VITE AUTOFILETTA NTE 4.2X11 TCS+ MARUTE</td> <td>3</td> <td>PZ</td> </tr> </tbody> </table>	Codice	Descrizione	Qtà	UM	0H7030A0	COPERCHIO INGRESSO BULBO	1	PZ	GN1531A0	GUARNIZIONE TENUTA INGRESSO BULBO	1	PZ	SL1045A0	SILICONE ANTRACITE S53 80 ML	1	PZ	TR1136A0	TERMOSTATO SIC. UNIP. 330°C	1	PZ	VI1220A1	VITE AUTOFILETTA NTE 4.2X11 TCS+ MARUTE	3	PZ
Codice	Descrizione	Qtà	UM																										
0H7030A0	COPERCHIO INGRESSO BULBO	1	PZ																										
GN1531A0	GUARNIZIONE TENUTA INGRESSO BULBO	1	PZ																										
SL1045A0	SILICONE ANTRACITE S53 80 ML	1	PZ																										
TR1136A0	TERMOSTATO SIC. UNIP. 330°C	1	PZ																										
VI1220A1	VITE AUTOFILETTA NTE 4.2X11 TCS+ MARUTE	3	PZ																										
VM1750A	MORSETTO A PETTINE		KVM1750A	KIT MORSETTIERA A PETTINE	<table border="1"> <thead> <tr> <th>Codice</th> <th>Descrizione</th> <th>Qtà</th> <th>UM</th> </tr> </thead> <tbody> <tr> <td>VM1750A0</td> <td>MORSETTO A PETTINE</td> <td>1</td> <td>PZ</td> </tr> </tbody> </table>	Codice	Descrizione	Qtà	UM	VM1750A0	MORSETTO A PETTINE	1	PZ																
Codice	Descrizione	Qtà	UM																										
VM1750A0	MORSETTO A PETTINE	1	PZ																										
VM2074A	CLIP CON VITE PER SUPPORTO CASSETTO		KVM1220A	KIT 4 PZ.CLIP SUPPORTO CASSETTI CT BT	<table border="1"> <thead> <tr> <th>Codice</th> <th>Descrizione</th> <th>Qtà</th> <th>UM</th> </tr> </thead> <tbody> <tr> <td>VI1220A1</td> <td>VITE AUTOFILETTA NTE 4.2X11 TCS+ MARUTE</td> <td>4</td> <td>PZ</td> </tr> <tr> <td>VM1220A0</td> <td>CLIP FISSAGGIO CASSETTO RACCOGLIGO CCE</td> <td>4</td> <td>PZ</td> </tr> <tr> <td>VM2074A0</td> <td>CLIP CON VITE PER SUPPORTO CASSETTO</td> <td>4</td> <td>PZ</td> </tr> </tbody> </table>	Codice	Descrizione	Qtà	UM	VI1220A1	VITE AUTOFILETTA NTE 4.2X11 TCS+ MARUTE	4	PZ	VM1220A0	CLIP FISSAGGIO CASSETTO RACCOGLIGO CCE	4	PZ	VM2074A0	CLIP CON VITE PER SUPPORTO CASSETTO	4	PZ								
Codice	Descrizione	Qtà	UM																										
VI1220A1	VITE AUTOFILETTA NTE 4.2X11 TCS+ MARUTE	4	PZ																										
VM1220A0	CLIP FISSAGGIO CASSETTO RACCOGLIGO CCE	4	PZ																										
VM2074A0	CLIP CON VITE PER SUPPORTO CASSETTO	4	PZ																										
VN1165A	VENTOLA RAFFREDDAMENTO 230VAC 50/60HZ 12		KVN1165A	KIT VENTOLA RAFFREDDAMENTO 120X120 230V	<table border="1"> <thead> <tr> <th>Codice</th> <th>Descrizione</th> <th>Qtà</th> <th>UM</th> </tr> </thead> <tbody> <tr> <td>VI1099A0</td> <td>VITE AUTOFORANT E 4.8X13 TCB+ ZN</td> <td>4</td> <td>PZ</td> </tr> <tr> <td>VM1555A2</td> <td>SUPPORTO VENTOLA RAFFREDDAM ENTO CT BT</td> <td>1</td> <td>PZ</td> </tr> <tr> <td>VN1165A0</td> <td>VENTOLA RAFFREDDAM ENTO 230VAC 50/60HZ 12</td> <td>1</td> <td>PZ</td> </tr> </tbody> </table>	Codice	Descrizione	Qtà	UM	VI1099A0	VITE AUTOFORANT E 4.8X13 TCB+ ZN	4	PZ	VM1555A2	SUPPORTO VENTOLA RAFFREDDAM ENTO CT BT	1	PZ	VN1165A0	VENTOLA RAFFREDDAM ENTO 230VAC 50/60HZ 12	1	PZ								
Codice	Descrizione	Qtà	UM																										
VI1099A0	VITE AUTOFORANT E 4.8X13 TCB+ ZN	4	PZ																										
VM1555A2	SUPPORTO VENTOLA RAFFREDDAM ENTO CT BT	1	PZ																										
VN1165A0	VENTOLA RAFFREDDAM ENTO 230VAC 50/60HZ 12	1	PZ																										



COMPONENTE			RICAMBIO																		
Codice	Descrizione	Immagine	Codice	Descrizione	Lista componenti																
VM1556A	PROTEZIONE VENTOLA RAFFREDDAMENTO CT BT		KVM1556A	KIT PROTEZIONE VENTOLA RAFFREDDAMENTO	<table border="1"> <thead> <tr> <th>Codice</th> <th>Descrizione</th> <th>Qtà</th> <th>UM</th> </tr> </thead> <tbody> <tr> <td>VM1556A0</td> <td>PROTEZIONE VENTOLA RAFFREDDAMENTO CT BT</td> <td>1</td> <td>PZ</td> </tr> </tbody> </table>	Codice	Descrizione	Qtà	UM	VM1556A0	PROTEZIONE VENTOLA RAFFREDDAMENTO CT BT	1	PZ								
Codice	Descrizione	Qtà	UM																		
VM1556A0	PROTEZIONE VENTOLA RAFFREDDAMENTO CT BT	1	PZ																		
VM1555A	SUPPORTO VENTOLA RAFFREDDAMENTO CT BT																				
VL1026A	CURVA PER TUBO DI SCARICO		KVL1026A	KIT CURVA PER TUBO DI SCARICO	<table border="1"> <thead> <tr> <th>Codice</th> <th>Descrizione</th> <th>Qtà</th> <th>UM</th> </tr> </thead> <tbody> <tr> <td>GN1400A0</td> <td>GUARNIZIONE SIFONE</td> <td>1</td> <td>PZ</td> </tr> <tr> <td>VL1026A0</td> <td>CURVA PER TUBO DI SCARICO</td> <td>1</td> <td>PZ</td> </tr> <tr> <td>VM2039A0</td> <td>ANELLO FISSAGGIO CURVA DI SCARICO</td> <td>1</td> <td>PZ</td> </tr> </tbody> </table>	Codice	Descrizione	Qtà	UM	GN1400A0	GUARNIZIONE SIFONE	1	PZ	VL1026A0	CURVA PER TUBO DI SCARICO	1	PZ	VM2039A0	ANELLO FISSAGGIO CURVA DI SCARICO	1	PZ
Codice	Descrizione	Qtà	UM																		
GN1400A0	GUARNIZIONE SIFONE	1	PZ																		
VL1026A0	CURVA PER TUBO DI SCARICO	1	PZ																		
VM2039A0	ANELLO FISSAGGIO CURVA DI SCARICO	1	PZ																		
VM2039A	ANELLO FISSAGGIO CURVA DI SCARICO		KVL1026A	KIT CURVA PER TUBO DI SCARICO	<table border="1"> <thead> <tr> <th>Codice</th> <th>Descrizione</th> <th>Qtà</th> <th>UM</th> </tr> </thead> <tbody> <tr> <td>GN1400A0</td> <td>GUARNIZIONE SIFONE</td> <td>1</td> <td>PZ</td> </tr> <tr> <td>VL1026A0</td> <td>CURVA PER TUBO DI SCARICO</td> <td>1</td> <td>PZ</td> </tr> <tr> <td>VM2039A0</td> <td>ANELLO FISSAGGIO CURVA DI SCARICO</td> <td>1</td> <td>PZ</td> </tr> </tbody> </table>	Codice	Descrizione	Qtà	UM	GN1400A0	GUARNIZIONE SIFONE	1	PZ	VL1026A0	CURVA PER TUBO DI SCARICO	1	PZ	VM2039A0	ANELLO FISSAGGIO CURVA DI SCARICO	1	PZ
Codice	Descrizione	Qtà	UM																		
GN1400A0	GUARNIZIONE SIFONE	1	PZ																		
VL1026A0	CURVA PER TUBO DI SCARICO	1	PZ																		
VM2039A0	ANELLO FISSAGGIO CURVA DI SCARICO	1	PZ																		
VM2249A	ANGOLO FACCIATA MUFFOLA PPS		KVM2249A	KIT ANGOLO FACCIATA MUFFOL	<table border="1"> <thead> <tr> <th>Codice</th> <th>Descrizione</th> <th>Qtà</th> <th>UM</th> </tr> </thead> <tbody> <tr> <td>VM2249A0</td> <td>ANGOLO FACCIATA MUFFOLA PPS</td> <td>1</td> <td>PZ</td> </tr> </tbody> </table>	Codice	Descrizione	Qtà	UM	VM2249A0	ANGOLO FACCIATA MUFFOLA PPS	1	PZ								
Codice	Descrizione	Qtà	UM																		
VM2249A0	ANGOLO FACCIATA MUFFOLA PPS	1	PZ																		



COMPONENTE			RICAMBIO																										
Codice	Descrizione	Immagine	Codice	Descrizione	Lista componenti																								
VM1991A	CASSETTO RACCOGLI GOCCE 750		KVM1991A	KIT CASSETTO RACCOGLI GOCCE	<table border="1"> <thead> <tr> <th>Codice</th> <th>Descrizione</th> <th>Qtà</th> <th>UM</th> </tr> </thead> <tbody> <tr> <td>VM1220A0</td> <td>CLIP FISSAGGIO CASSETTO RACCOGLIGO GOCCE</td> <td>4</td> <td>PZ</td> </tr> <tr> <td>VM1794A0</td> <td>FASCETTA 250X4.8 PA66 NERA</td> <td>2</td> <td>PZ</td> </tr> <tr> <td>VM1991A0</td> <td>CASSETTO RACCOGLI GOCCE 750</td> <td>1</td> <td>PZ</td> </tr> <tr> <td>VM2074A0</td> <td>CLIP CON VITE PER SUPPORTO CASSETTO</td> <td>4</td> <td>PZ</td> </tr> <tr> <td>VM2103A0</td> <td>PIASTRINA FERMAFASCE TTA</td> <td>2</td> <td>PZ</td> </tr> </tbody> </table>	Codice	Descrizione	Qtà	UM	VM1220A0	CLIP FISSAGGIO CASSETTO RACCOGLIGO GOCCE	4	PZ	VM1794A0	FASCETTA 250X4.8 PA66 NERA	2	PZ	VM1991A0	CASSETTO RACCOGLI GOCCE 750	1	PZ	VM2074A0	CLIP CON VITE PER SUPPORTO CASSETTO	4	PZ	VM2103A0	PIASTRINA FERMAFASCE TTA	2	PZ
Codice	Descrizione	Qtà	UM																										
VM1220A0	CLIP FISSAGGIO CASSETTO RACCOGLIGO GOCCE	4	PZ																										
VM1794A0	FASCETTA 250X4.8 PA66 NERA	2	PZ																										
VM1991A0	CASSETTO RACCOGLI GOCCE 750	1	PZ																										
VM2074A0	CLIP CON VITE PER SUPPORTO CASSETTO	4	PZ																										
VM2103A0	PIASTRINA FERMAFASCE TTA	2	PZ																										
VM2035A	SUPPORTO PER TUBO DI SCARICO		KVM2035A	KIT 2 PZ SUPPORTO PER TUBO DI SCARICO	<table border="1"> <thead> <tr> <th>Codice</th> <th>Descrizione</th> <th>Qtà</th> <th>UM</th> </tr> </thead> <tbody> <tr> <td>VM2035A0</td> <td>SUPPORTO PER TUBO DI SCARICO</td> <td>2</td> <td>PZ</td> </tr> </tbody> </table>	Codice	Descrizione	Qtà	UM	VM2035A0	SUPPORTO PER TUBO DI SCARICO	2	PZ																
Codice	Descrizione	Qtà	UM																										
VM2035A0	SUPPORTO PER TUBO DI SCARICO	2	PZ																										
VM1810A	TAPPO TENUTA ACQUA DX		VM1810A0	TAPPO TENUTA ACQUA DX																									
VM1811A	TAPPO TENUTA ACQUA SX		VM1811A0	TAPPO TENUTA ACQUA SX																									

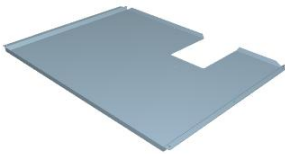

COMPONENTE			RICAMBIO														
Codice	Descrizione	Immagine	Codice	Descrizione	Lista componenti												
VM2311A	PIASTRINA COPRI VITI		KVM2311A	KIT PIASTRINA COPRIVITI VM2311A	<table border="1"> <thead> <tr> <th>Codice</th> <th>Descrizione</th> <th>Qtà</th> <th>UM</th> </tr> </thead> <tbody> <tr> <td>VM2311A0</td> <td>PIASTRINA COPRI VITI</td> <td>1</td> <td>PZ</td> </tr> </tbody> </table>	Codice	Descrizione	Qtà	UM	VM2311A0	PIASTRINA COPRI VITI	1	PZ				
Codice	Descrizione	Qtà	UM														
VM2311A0	PIASTRINA COPRI VITI	1	PZ														
GN1558A	GUARNIZIONE TENUTA CAMINO		K0H7291A	KIT DISCO E GUARNIZIONE TENUTA CAMINO	<table border="1"> <thead> <tr> <th>Codice</th> <th>Descrizione</th> <th>Qtà</th> <th>UM</th> </tr> </thead> <tbody> <tr> <td>0H7291A0</td> <td>DISCO TENUTA CAMINO</td> <td>1</td> <td>PZ</td> </tr> <tr> <td>GN1558A0</td> <td>GUARNIZIONE TENUTA CAMINO</td> <td>1</td> <td>PZ</td> </tr> </tbody> </table>	Codice	Descrizione	Qtà	UM	0H7291A0	DISCO TENUTA CAMINO	1	PZ	GN1558A0	GUARNIZIONE TENUTA CAMINO	1	PZ
Codice	Descrizione	Qtà	UM														
0H7291A0	DISCO TENUTA CAMINO	1	PZ														
GN1558A0	GUARNIZIONE TENUTA CAMINO	1	PZ														
0H7291A	DISCO TENUTA CAMINO		K0H7291A	KIT DISCO E GUARNIZIONE TENUTA CAMINO	<table border="1"> <thead> <tr> <th>Codice</th> <th>Descrizione</th> <th>Qtà</th> <th>UM</th> </tr> </thead> <tbody> <tr> <td>0H7291A0</td> <td>DISCO TENUTA CAMINO</td> <td>1</td> <td>PZ</td> </tr> <tr> <td>GN1558A0</td> <td>GUARNIZIONE TENUTA CAMINO</td> <td>1</td> <td>PZ</td> </tr> </tbody> </table>	Codice	Descrizione	Qtà	UM	0H7291A0	DISCO TENUTA CAMINO	1	PZ	GN1558A0	GUARNIZIONE TENUTA CAMINO	1	PZ
Codice	Descrizione	Qtà	UM														
0H7291A0	DISCO TENUTA CAMINO	1	PZ														
GN1558A0	GUARNIZIONE TENUTA CAMINO	1	PZ														
VM1118A	GUIDA SX SERBATOIO DET&RINSE PLUS		KVM1118A	KIT GUIDA SX SERBATOIO DET.M	<table border="1"> <thead> <tr> <th>Codice</th> <th>Descrizione</th> <th>Qtà</th> <th>UM</th> </tr> </thead> <tbody> <tr> <td>VI1220A1</td> <td>VITE AUTOFILETTA NTE 4.2X11 TCS+ MARUTE</td> <td>2</td> <td>PZ</td> </tr> <tr> <td>VM1118A0</td> <td>GUIDA SX SERBATOIO DET&amp;RINSE PLUS</td> <td>1</td> <td>PZ</td> </tr> </tbody> </table>	Codice	Descrizione	Qtà	UM	VI1220A1	VITE AUTOFILETTA NTE 4.2X11 TCS+ MARUTE	2	PZ	VM1118A0	GUIDA SX SERBATOIO DET&RINSE PLUS	1	PZ
Codice	Descrizione	Qtà	UM														
VI1220A1	VITE AUTOFILETTA NTE 4.2X11 TCS+ MARUTE	2	PZ														
VM1118A0	GUIDA SX SERBATOIO DET&RINSE PLUS	1	PZ														
VM1119A	GUIDA DX SERBATOIO DET&RINSE PLUS		KVM1119A	KIT GUIDA DX SERBATOIO DET.M	<table border="1"> <thead> <tr> <th>Codice</th> <th>Descrizione</th> <th>Qtà</th> <th>UM</th> </tr> </thead> <tbody> <tr> <td>VI1220A1</td> <td>VITE AUTOFILETTA NTE 4.2X11 TCS+ MARUTE</td> <td>2</td> <td>PZ</td> </tr> <tr> <td>VM1119A0</td> <td>GUIDA DX SERBATOIO DET&amp;RINSE PLUS</td> <td>1</td> <td>PZ</td> </tr> </tbody> </table>	Codice	Descrizione	Qtà	UM	VI1220A1	VITE AUTOFILETTA NTE 4.2X11 TCS+ MARUTE	2	PZ	VM1119A0	GUIDA DX SERBATOIO DET&RINSE PLUS	1	PZ
Codice	Descrizione	Qtà	UM														
VI1220A1	VITE AUTOFILETTA NTE 4.2X11 TCS+ MARUTE	2	PZ														
VM1119A0	GUIDA DX SERBATOIO DET&RINSE PLUS	1	PZ														









COMPONENTE			RICAMBIO																																																																																		
Codice	Descrizione	Immagine	Codice	Descrizione	Lista componenti																																																																																
SB1015A	SERBATOIO DETERGENTE 4L + ROMPI-CIALDA		XUC060	KIT TANICA DETERGENTE PER LIEVITATORE	<table border="1"> <thead> <tr> <th>Codice</th> <th>Descrizione</th> <th>Qtà</th> <th>UM</th> </tr> </thead> <tbody> <tr> <td>0H7558B0</td> <td>GUIDA TANICA DETERGENTE</td> <td>1</td> <td>PZ</td> </tr> <tr> <td>0H7559B0</td> <td>FRONTALINO KIT TANICA</td> <td>2</td> <td>PZ</td> </tr> <tr> <td>0H7656A0</td> <td>GUIDA TANICA DETERGENTE</td> <td>1</td> <td>PZ</td> </tr> <tr> <td>0H7657A0</td> <td>FRONTALINO KIT TANICA</td> <td>2</td> <td>PZ</td> </tr> <tr> <td>CE1016A0</td> <td>TERMINALE AD OCCHIELLO D=4,3 MM</td> <td>2</td> <td>PZ</td> </tr> <tr> <td>CE1630A1</td> <td>CAVO UNIP AWG16 ST.3135 NERO</td> <td>0.680</td> <td>M</td> </tr> <tr> <td>EL1220A0</td> <td>RACCORDO DRITTO Ø8F-Ø8F</td> <td>1</td> <td>PZ</td> </tr> <tr> <td>IP1385A1</td> <td>IMB POL ANGOLARE 110X80X2000 D30</td> <td>3.520</td> <td>M</td> </tr> <tr> <td>RC1019A0</td> <td>FASCETTA ELASTICA D10 ZINCATA</td> <td>2</td> <td>PZ</td> </tr> <tr> <td>SB1015A1</td> <td>SERBATOIO DETERGENTE 4L + ROMPI-CIALD</td> <td>1</td> <td>PZ</td> </tr> <tr> <td>TB2820A0</td> <td>TUBO EPDM 6X10</td> <td>2</td> <td>M</td> </tr> <tr> <td>VH1220A1</td> <td>VITE AUTOFILETTA NTE 4.2X11 TCS+ MARUTE</td> <td>9</td> <td>PZ</td> </tr> <tr> <td>VI1225A0</td> <td>RIVETTO STRUTT. 4X10.1 INOX</td> <td>8</td> <td>PZ</td> </tr> <tr> <td>VI1950A0</td> <td>VITE AUTOFORANT E 4,2X13 TCB INOX</td> <td>4</td> <td>PZ</td> </tr> <tr> <td>VL1047A1</td> <td>PORTAGOMM A D6 CODOLO D8</td> <td>2</td> <td>PZ</td> </tr> <tr> <td>VL1047A2</td> <td>PORTAGOMM A D6 CODOLO D8</td> <td>2</td> <td>PZ</td> </tr> <tr> <td>VM1059A1</td> <td>FILM TERMORETRA IBILE H800</td> <td>2</td> <td>M</td> </tr> <tr> <td>VM1197A0</td> <td>CORNICE SERBATOIO DET. MM BIG</td> <td>2</td> <td>PZ</td> </tr> <tr> <td>VM1198A0</td> <td>CLIP BLOCCA CORNICE SERBATOIO DET. MM</td> <td>8</td> <td>PZ</td> </tr> </tbody> </table>	Codice	Descrizione	Qtà	UM	0H7558B0	GUIDA TANICA DETERGENTE	1	PZ	0H7559B0	FRONTALINO KIT TANICA	2	PZ	0H7656A0	GUIDA TANICA DETERGENTE	1	PZ	0H7657A0	FRONTALINO KIT TANICA	2	PZ	CE1016A0	TERMINALE AD OCCHIELLO D=4,3 MM	2	PZ	CE1630A1	CAVO UNIP AWG16 ST.3135 NERO	0.680	M	EL1220A0	RACCORDO DRITTO Ø8F-Ø8F	1	PZ	IP1385A1	IMB POL ANGOLARE 110X80X2000 D30	3.520	M	RC1019A0	FASCETTA ELASTICA D10 ZINCATA	2	PZ	SB1015A1	SERBATOIO DETERGENTE 4L + ROMPI-CIALD	1	PZ	TB2820A0	TUBO EPDM 6X10	2	M	VH1220A1	VITE AUTOFILETTA NTE 4.2X11 TCS+ MARUTE	9	PZ	VI1225A0	RIVETTO STRUTT. 4X10.1 INOX	8	PZ	VI1950A0	VITE AUTOFORANT E 4,2X13 TCB INOX	4	PZ	VL1047A1	PORTAGOMM A D6 CODOLO D8	2	PZ	VL1047A2	PORTAGOMM A D6 CODOLO D8	2	PZ	VM1059A1	FILM TERMORETRA IBILE H800	2	M	VM1197A0	CORNICE SERBATOIO DET. MM BIG	2	PZ	VM1198A0	CLIP BLOCCA CORNICE SERBATOIO DET. MM	8	PZ
Codice	Descrizione	Qtà	UM																																																																																		
0H7558B0	GUIDA TANICA DETERGENTE	1	PZ																																																																																		
0H7559B0	FRONTALINO KIT TANICA	2	PZ																																																																																		
0H7656A0	GUIDA TANICA DETERGENTE	1	PZ																																																																																		
0H7657A0	FRONTALINO KIT TANICA	2	PZ																																																																																		
CE1016A0	TERMINALE AD OCCHIELLO D=4,3 MM	2	PZ																																																																																		
CE1630A1	CAVO UNIP AWG16 ST.3135 NERO	0.680	M																																																																																		
EL1220A0	RACCORDO DRITTO Ø8F-Ø8F	1	PZ																																																																																		
IP1385A1	IMB POL ANGOLARE 110X80X2000 D30	3.520	M																																																																																		
RC1019A0	FASCETTA ELASTICA D10 ZINCATA	2	PZ																																																																																		
SB1015A1	SERBATOIO DETERGENTE 4L + ROMPI-CIALD	1	PZ																																																																																		
TB2820A0	TUBO EPDM 6X10	2	M																																																																																		
VH1220A1	VITE AUTOFILETTA NTE 4.2X11 TCS+ MARUTE	9	PZ																																																																																		
VI1225A0	RIVETTO STRUTT. 4X10.1 INOX	8	PZ																																																																																		
VI1950A0	VITE AUTOFORANT E 4,2X13 TCB INOX	4	PZ																																																																																		
VL1047A1	PORTAGOMM A D6 CODOLO D8	2	PZ																																																																																		
VL1047A2	PORTAGOMM A D6 CODOLO D8	2	PZ																																																																																		
VM1059A1	FILM TERMORETRA IBILE H800	2	M																																																																																		
VM1197A0	CORNICE SERBATOIO DET. MM BIG	2	PZ																																																																																		
VM1198A0	CLIP BLOCCA CORNICE SERBATOIO DET. MM	8	PZ																																																																																		

COMPONENTE			RICAMBIO																										
Codice	Descrizione	Immagine	Codice	Descrizione	Lista componenti																								
SB1015A	SERBATOIO DETERGENTE 4L + ROMPI-CIALDA		KSB1015A	KIT SERBATOIO DETERGENTE 4L	<table border="1"> <thead> <tr> <th>Codice</th> <th>Descrizione</th> <th>Qtà</th> <th>UM</th> </tr> </thead> <tbody> <tr> <td>IP1385A1</td> <td>IMB POL ANGOLARE 110X80X2000 D30</td> <td>1.200</td> <td>M</td> </tr> <tr> <td>IP1410A0</td> <td>IMB POL SALVAVETRO 300X300X8 D1</td> <td>2</td> <td>PZ</td> </tr> <tr> <td>SB1015A1</td> <td>SERBATOIO DETERGENTE 4L + ROMPI-CIALD</td> <td>1</td> <td>PZ</td> </tr> <tr> <td>VM1059A1</td> <td>FILM TERMOMETRA IBILE H800</td> <td>1.200</td> <td>M</td> </tr> </tbody> </table>	Codice	Descrizione	Qtà	UM	IP1385A1	IMB POL ANGOLARE 110X80X2000 D30	1.200	M	IP1410A0	IMB POL SALVAVETRO 300X300X8 D1	2	PZ	SB1015A1	SERBATOIO DETERGENTE 4L + ROMPI-CIALD	1	PZ	VM1059A1	FILM TERMOMETRA IBILE H800	1.200	M				
Codice	Descrizione	Qtà	UM																										
IP1385A1	IMB POL ANGOLARE 110X80X2000 D30	1.200	M																										
IP1410A0	IMB POL SALVAVETRO 300X300X8 D1	2	PZ																										
SB1015A1	SERBATOIO DETERGENTE 4L + ROMPI-CIALD	1	PZ																										
VM1059A1	FILM TERMOMETRA IBILE H800	1.200	M																										
0F1496A	SCHIENA XEVC-0511-E		0F1496A0	SCHIENA XEVC-0511-E																									
VM1190A	SCROCCO MANIGLIA DX CT BT		KVM1190A	KIT SCROCCO MANIGLIA DX CT BT	<table border="1"> <thead> <tr> <th>Codice</th> <th>Descrizione</th> <th>Qtà</th> <th>UM</th> </tr> </thead> <tbody> <tr> <td>VI0239A1</td> <td>VITE AUTOFIL. 4.2X25 TCB+ INOX</td> <td>2</td> <td>PZ</td> </tr> <tr> <td>VI1220A1</td> <td>VITE AUTOFILETTA NTE 4.2X11 TCS+ MARUTE</td> <td>2</td> <td>PZ</td> </tr> <tr> <td>VM1190A2</td> <td>SCROCCO MANIGLIA DX CT BT</td> <td>1</td> <td>PZ</td> </tr> <tr> <td>VM1192A1</td> <td>COPERCHIO POST. SCROCCO MANIGLIA CT BT</td> <td>1</td> <td>PZ</td> </tr> <tr> <td>VM1460A0</td> <td>COPERCHIO DX SCROCCO PORTA XBC/XVC</td> <td>1</td> <td>PZ</td> </tr> </tbody> </table>	Codice	Descrizione	Qtà	UM	VI0239A1	VITE AUTOFIL. 4.2X25 TCB+ INOX	2	PZ	VI1220A1	VITE AUTOFILETTA NTE 4.2X11 TCS+ MARUTE	2	PZ	VM1190A2	SCROCCO MANIGLIA DX CT BT	1	PZ	VM1192A1	COPERCHIO POST. SCROCCO MANIGLIA CT BT	1	PZ	VM1460A0	COPERCHIO DX SCROCCO PORTA XBC/XVC	1	PZ
Codice	Descrizione	Qtà	UM																										
VI0239A1	VITE AUTOFIL. 4.2X25 TCB+ INOX	2	PZ																										
VI1220A1	VITE AUTOFILETTA NTE 4.2X11 TCS+ MARUTE	2	PZ																										
VM1190A2	SCROCCO MANIGLIA DX CT BT	1	PZ																										
VM1192A1	COPERCHIO POST. SCROCCO MANIGLIA CT BT	1	PZ																										
VM1460A0	COPERCHIO DX SCROCCO PORTA XBC/XVC	1	PZ																										





COMPONENTE			RICAMBIO																										
Codice	Descrizione	Immagine	Codice	Descrizione	Lista componenti																								
VM2280A	PIASTRINA COPRI SCROCCO		KVM2280A	KIT PIASTRINA COPRI SCROCCO VM2280A	<table border="1"> <thead> <tr> <th>Codice</th> <th>Descrizione</th> <th>Qtà</th> <th>UM</th> </tr> </thead> <tbody> <tr> <td>VM2280A0</td> <td>PIASTRINA COPRI SCROCCO</td> <td>1</td> <td>PZ</td> </tr> </tbody> </table>	Codice	Descrizione	Qtà	UM	VM2280A0	PIASTRINA COPRI SCROCCO	1	PZ																
Codice	Descrizione	Qtà	UM																										
VM2280A0	PIASTRINA COPRI SCROCCO	1	PZ																										
VM1192A	COPERCHIO POST. SCROCCO MANIGLIA CT BT		KVM1191A	KIT SCROCCO MANIGLIA SX CT BT	<table border="1"> <thead> <tr> <th>Codice</th> <th>Descrizione</th> <th>Qtà</th> <th>UM</th> </tr> </thead> <tbody> <tr> <td>VI0239A1</td> <td>VITE AUTOFIL. 4.2X25 TCB+ INOX</td> <td>2</td> <td>PZ</td> </tr> <tr> <td>VI1220A1</td> <td>VITE AUTOFILETTA NTE 4.2X11 TCS+ MARUTE</td> <td>2</td> <td>PZ</td> </tr> <tr> <td>VM1191A2</td> <td>SCROCCO MANIGLIA SX CT BT</td> <td>1</td> <td>PZ</td> </tr> <tr> <td>VM1192A1</td> <td>COPERCHIO POST. SCROCCO MANIGLIA CT BT</td> <td>1</td> <td>PZ</td> </tr> <tr> <td>VM1460A0</td> <td>COPERCHIO DX SCROCCO PORTA XBC/XVC</td> <td>1</td> <td>PZ</td> </tr> </tbody> </table>	Codice	Descrizione	Qtà	UM	VI0239A1	VITE AUTOFIL. 4.2X25 TCB+ INOX	2	PZ	VI1220A1	VITE AUTOFILETTA NTE 4.2X11 TCS+ MARUTE	2	PZ	VM1191A2	SCROCCO MANIGLIA SX CT BT	1	PZ	VM1192A1	COPERCHIO POST. SCROCCO MANIGLIA CT BT	1	PZ	VM1460A0	COPERCHIO DX SCROCCO PORTA XBC/XVC	1	PZ
Codice	Descrizione	Qtà	UM																										
VI0239A1	VITE AUTOFIL. 4.2X25 TCB+ INOX	2	PZ																										
VI1220A1	VITE AUTOFILETTA NTE 4.2X11 TCS+ MARUTE	2	PZ																										
VM1191A2	SCROCCO MANIGLIA SX CT BT	1	PZ																										
VM1192A1	COPERCHIO POST. SCROCCO MANIGLIA CT BT	1	PZ																										
VM1460A0	COPERCHIO DX SCROCCO PORTA XBC/XVC	1	PZ																										
			KVM1190A	KIT SCROCCO MANIGLIA DX CT BT	<table border="1"> <thead> <tr> <th>Codice</th> <th>Descrizione</th> <th>Qtà</th> <th>UM</th> </tr> </thead> <tbody> <tr> <td>VI0239A1</td> <td>VITE AUTOFIL. 4.2X25 TCB+ INOX</td> <td>2</td> <td>PZ</td> </tr> <tr> <td>VI1220A1</td> <td>VITE AUTOFILETTA NTE 4.2X11 TCS+ MARUTE</td> <td>2</td> <td>PZ</td> </tr> <tr> <td>VM1190A2</td> <td>SCROCCO MANIGLIA DX CT BT</td> <td>1</td> <td>PZ</td> </tr> <tr> <td>VM1192A1</td> <td>COPERCHIO POST. SCROCCO MANIGLIA CT BT</td> <td>1</td> <td>PZ</td> </tr> <tr> <td>VM1460A0</td> <td>COPERCHIO DX SCROCCO PORTA XBC/XVC</td> <td>1</td> <td>PZ</td> </tr> </tbody> </table>	Codice	Descrizione	Qtà	UM	VI0239A1	VITE AUTOFIL. 4.2X25 TCB+ INOX	2	PZ	VI1220A1	VITE AUTOFILETTA NTE 4.2X11 TCS+ MARUTE	2	PZ	VM1190A2	SCROCCO MANIGLIA DX CT BT	1	PZ	VM1192A1	COPERCHIO POST. SCROCCO MANIGLIA CT BT	1	PZ	VM1460A0	COPERCHIO DX SCROCCO PORTA XBC/XVC	1	PZ
Codice	Descrizione	Qtà	UM																										
VI0239A1	VITE AUTOFIL. 4.2X25 TCB+ INOX	2	PZ																										
VI1220A1	VITE AUTOFILETTA NTE 4.2X11 TCS+ MARUTE	2	PZ																										
VM1190A2	SCROCCO MANIGLIA DX CT BT	1	PZ																										
VM1192A1	COPERCHIO POST. SCROCCO MANIGLIA CT BT	1	PZ																										
VM1460A0	COPERCHIO DX SCROCCO PORTA XBC/XVC	1	PZ																										

COMPONENTE			RICAMBIO																										
Codice	Descrizione	Immagine	Codice	Descrizione	Lista componenti																								
VM2281A	PIASTRINA COPRI FORI		KVM2281A	KIT PIASTRINA COPRI FORI VM2281A0	<table border="1"> <thead> <tr> <th>Codice</th> <th>Descrizione</th> <th>Qtà</th> <th>UM</th> </tr> </thead> <tbody> <tr> <td>VM2281A0</td> <td>PIASTRINA COPRI FORI</td> <td>1</td> <td>PZ</td> </tr> </tbody> </table>	Codice	Descrizione	Qtà	UM	VM2281A0	PIASTRINA COPRI FORI	1	PZ																
Codice	Descrizione	Qtà	UM																										
VM2281A0	PIASTRINA COPRI FORI	1	PZ																										
VM1192A	COPERCHIO POST. SCROCCO MANIGLIA CT BT		KVM1191A	KIT SCROCCO MANIGLIA SX CT BT	<table border="1"> <thead> <tr> <th>Codice</th> <th>Descrizione</th> <th>Qtà</th> <th>UM</th> </tr> </thead> <tbody> <tr> <td>VI0239A1</td> <td>VITE AUTOFIL. 4.2X25 TCB+ INOX</td> <td>2</td> <td>PZ</td> </tr> <tr> <td>VI1220A1</td> <td>VITE AUTOFILETTA NTE 4.2X11 TCS+ MARUTE</td> <td>2</td> <td>PZ</td> </tr> <tr> <td>VM1191A2</td> <td>SCROCCO MANIGLIA SX CT BT</td> <td>1</td> <td>PZ</td> </tr> <tr> <td>VM1192A1</td> <td>COPERCHIO POST. SCROCCO MANIGLIA CT BT</td> <td>1</td> <td>PZ</td> </tr> <tr> <td>VM1460A0</td> <td>COPERCHIO DX SCROCCO PORTA XBC/XVC</td> <td>1</td> <td>PZ</td> </tr> </tbody> </table>	Codice	Descrizione	Qtà	UM	VI0239A1	VITE AUTOFIL. 4.2X25 TCB+ INOX	2	PZ	VI1220A1	VITE AUTOFILETTA NTE 4.2X11 TCS+ MARUTE	2	PZ	VM1191A2	SCROCCO MANIGLIA SX CT BT	1	PZ	VM1192A1	COPERCHIO POST. SCROCCO MANIGLIA CT BT	1	PZ	VM1460A0	COPERCHIO DX SCROCCO PORTA XBC/XVC	1	PZ
Codice	Descrizione	Qtà	UM																										
VI0239A1	VITE AUTOFIL. 4.2X25 TCB+ INOX	2	PZ																										
VI1220A1	VITE AUTOFILETTA NTE 4.2X11 TCS+ MARUTE	2	PZ																										
VM1191A2	SCROCCO MANIGLIA SX CT BT	1	PZ																										
VM1192A1	COPERCHIO POST. SCROCCO MANIGLIA CT BT	1	PZ																										
VM1460A0	COPERCHIO DX SCROCCO PORTA XBC/XVC	1	PZ																										
			KVM1190A	KIT SCROCCO MANIGLIA DX CT BT	<table border="1"> <thead> <tr> <th>Codice</th> <th>Descrizione</th> <th>Qtà</th> <th>UM</th> </tr> </thead> <tbody> <tr> <td>VI0239A1</td> <td>VITE AUTOFIL. 4.2X25 TCB+ INOX</td> <td>2</td> <td>PZ</td> </tr> <tr> <td>VI1220A1</td> <td>VITE AUTOFILETTA NTE 4.2X11 TCS+ MARUTE</td> <td>2</td> <td>PZ</td> </tr> <tr> <td>VM1190A2</td> <td>SCROCCO MANIGLIA DX CT BT</td> <td>1</td> <td>PZ</td> </tr> <tr> <td>VM1192A1</td> <td>COPERCHIO POST. SCROCCO MANIGLIA CT BT</td> <td>1</td> <td>PZ</td> </tr> <tr> <td>VM1460A0</td> <td>COPERCHIO DX SCROCCO PORTA XBC/XVC</td> <td>1</td> <td>PZ</td> </tr> </tbody> </table>	Codice	Descrizione	Qtà	UM	VI0239A1	VITE AUTOFIL. 4.2X25 TCB+ INOX	2	PZ	VI1220A1	VITE AUTOFILETTA NTE 4.2X11 TCS+ MARUTE	2	PZ	VM1190A2	SCROCCO MANIGLIA DX CT BT	1	PZ	VM1192A1	COPERCHIO POST. SCROCCO MANIGLIA CT BT	1	PZ	VM1460A0	COPERCHIO DX SCROCCO PORTA XBC/XVC	1	PZ
Codice	Descrizione	Qtà	UM																										
VI0239A1	VITE AUTOFIL. 4.2X25 TCB+ INOX	2	PZ																										
VI1220A1	VITE AUTOFILETTA NTE 4.2X11 TCS+ MARUTE	2	PZ																										
VM1190A2	SCROCCO MANIGLIA DX CT BT	1	PZ																										
VM1192A1	COPERCHIO POST. SCROCCO MANIGLIA CT BT	1	PZ																										
VM1460A0	COPERCHIO DX SCROCCO PORTA XBC/XVC	1	PZ																										

COMPONENTE			RICAMBIO																										
Codice	Descrizione	Immagine	Codice	Descrizione	Lista componenti																								
VM1191A	SCROCCO MANIGLIA SX CT BT		KVM1191A	KIT SCROCCO MANIGLIA SX CT BT	<table border="1"> <thead> <tr> <th>Codice</th> <th>Descrizione</th> <th>Qtà</th> <th>UM</th> </tr> </thead> <tbody> <tr> <td>VI0239A1</td> <td>VITE AUTOFIL. 4.2X25 TCB+ INOX</td> <td>2</td> <td>PZ</td> </tr> <tr> <td>VI1220A1</td> <td>VITE AUTOFILETTA NTE 4.2X11 TCS+ MARUTE</td> <td>2</td> <td>PZ</td> </tr> <tr> <td>VM1191A2</td> <td>SCROCCO MANIGLIA SX CT BT</td> <td>1</td> <td>PZ</td> </tr> <tr> <td>VM1192A1</td> <td>COPERCHIO POST. SCROCCO MANIGLIA CT BT</td> <td>1</td> <td>PZ</td> </tr> <tr> <td>VM1460A0</td> <td>COPERCHIO DX SCROCCO PORTA XBC/XVC</td> <td>1</td> <td>PZ</td> </tr> </tbody> </table>	Codice	Descrizione	Qtà	UM	VI0239A1	VITE AUTOFIL. 4.2X25 TCB+ INOX	2	PZ	VI1220A1	VITE AUTOFILETTA NTE 4.2X11 TCS+ MARUTE	2	PZ	VM1191A2	SCROCCO MANIGLIA SX CT BT	1	PZ	VM1192A1	COPERCHIO POST. SCROCCO MANIGLIA CT BT	1	PZ	VM1460A0	COPERCHIO DX SCROCCO PORTA XBC/XVC	1	PZ
Codice	Descrizione	Qtà	UM																										
VI0239A1	VITE AUTOFIL. 4.2X25 TCB+ INOX	2	PZ																										
VI1220A1	VITE AUTOFILETTA NTE 4.2X11 TCS+ MARUTE	2	PZ																										
VM1191A2	SCROCCO MANIGLIA SX CT BT	1	PZ																										
VM1192A1	COPERCHIO POST. SCROCCO MANIGLIA CT BT	1	PZ																										
VM1460A0	COPERCHIO DX SCROCCO PORTA XBC/XVC	1	PZ																										
0H2561A	CONTROSTAFFA PORTA MM		0H2561A0	CONTROSTAFFA PORTA MM																									
VM1240A	TAPPO NYLON SUPPORTO CONTROSTAFFA		KVM1240A	KIT TAPPO SUPPORTO CONTROSTAFFA 4P	<table border="1"> <thead> <tr> <th>Codice</th> <th>Descrizione</th> <th>Qtà</th> <th>UM</th> </tr> </thead> <tbody> <tr> <td>VM1240A0</td> <td>TAPPO NYLON SUPPORTO CONTROSTAFFA FA</td> <td>4</td> <td>PZ</td> </tr> </tbody> </table>	Codice	Descrizione	Qtà	UM	VM1240A0	TAPPO NYLON SUPPORTO CONTROSTAFFA FA	4	PZ																
Codice	Descrizione	Qtà	UM																										
VM1240A0	TAPPO NYLON SUPPORTO CONTROSTAFFA FA	4	PZ																										
VM2282A	PIASTRINA SUPPORTO MICROPORTA		KVM2282A	KIT PIASTRINA SUPPORTO MICROPORTA	<table border="1"> <thead> <tr> <th>Codice</th> <th>Descrizione</th> <th>Qtà</th> <th>UM</th> </tr> </thead> <tbody> <tr> <td>VM2282A0</td> <td>PIASTRINA SUPPORTO MICROPORTA</td> <td>1</td> <td>PZ</td> </tr> </tbody> </table>	Codice	Descrizione	Qtà	UM	VM2282A0	PIASTRINA SUPPORTO MICROPORTA	1	PZ																
Codice	Descrizione	Qtà	UM																										
VM2282A0	PIASTRINA SUPPORTO MICROPORTA	1	PZ																										

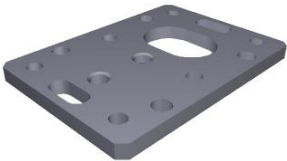
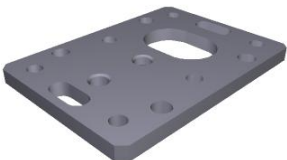



COMPONENTE			RICAMBIO																																		
Codice	Descrizione	Immagine	Codice	Descrizione	Lista componenti																																
VE1020B	MICROINT. PORTA MAGNETICO CON MINIFIT 2P		KVE1020B	KIT MICROPORTA	<table border="1"> <thead> <tr> <th>Codice</th> <th>Descrizione</th> <th>Qtà</th> <th>UM</th> </tr> </thead> <tbody> <tr> <td>CE1030A0</td> <td>FASTON FEMMINA 6.3X0.8 0,5-1MMQ</td> <td>2</td> <td>PZ</td> </tr> <tr> <td>CE1660A0</td> <td>COPRI FASTON FEMMINA 6.3X0.8</td> <td>2</td> <td>PZ</td> </tr> <tr> <td>CE1730A0</td> <td>CAVO PVC NP 2 X AWG22 STYLE 2095</td> <td>0.150</td> <td>M</td> </tr> <tr> <td>CE1740A0</td> <td>TERMINALE MINIFIT MASCHIO</td> <td>2</td> <td>PZ</td> </tr> <tr> <td>CE1745A0</td> <td>CONNETTORE MINIFIT FEMMINA 2 VI</td> <td>1</td> <td>PZ</td> </tr> <tr> <td>VE1020B0</td> <td>MICROINT. PORTA MAGNETICO CON MINIFIT 2</td> <td>1</td> <td>PZ</td> </tr> <tr> <td>VE1030A1</td> <td>CALAMITA D=22,9MM PER MICROPORTA</td> <td>1</td> <td>PZ</td> </tr> </tbody> </table>	Codice	Descrizione	Qtà	UM	CE1030A0	FASTON FEMMINA 6.3X0.8 0,5-1MMQ	2	PZ	CE1660A0	COPRI FASTON FEMMINA 6.3X0.8	2	PZ	CE1730A0	CAVO PVC NP 2 X AWG22 STYLE 2095	0.150	M	CE1740A0	TERMINALE MINIFIT MASCHIO	2	PZ	CE1745A0	CONNETTORE MINIFIT FEMMINA 2 VI	1	PZ	VE1020B0	MICROINT. PORTA MAGNETICO CON MINIFIT 2	1	PZ	VE1030A1	CALAMITA D=22,9MM PER MICROPORTA	1	PZ
					Codice	Descrizione	Qtà	UM																													
					CE1030A0	FASTON FEMMINA 6.3X0.8 0,5-1MMQ	2	PZ																													
					CE1660A0	COPRI FASTON FEMMINA 6.3X0.8	2	PZ																													
					CE1730A0	CAVO PVC NP 2 X AWG22 STYLE 2095	0.150	M																													
					CE1740A0	TERMINALE MINIFIT MASCHIO	2	PZ																													
					CE1745A0	CONNETTORE MINIFIT FEMMINA 2 VI	1	PZ																													
					VE1020B0	MICROINT. PORTA MAGNETICO CON MINIFIT 2	1	PZ																													
VE1030A1	CALAMITA D=22,9MM PER MICROPORTA	1	PZ																																		
0H7675A	CONTROSTAFFA PORTA SERIE 6																																				
0H2561A	CONTROSTAFFA PORTA MM		0H2561A0	CONTROSTAFFA PORTA MM																																	





COMPONENTE			RICAMBIO																														
Codice	Descrizione	Immagine	Codice	Descrizione	Lista componenti																												
VM2352A	TAPPO SX COPRI VITI STAFFA PORTA INF MM		VM2352A0	TAPPO SX COPRI VITI STAFFA PORTA INF MM																													
VM2353A	TAPPO DX COPRI VITI STAFFA PORTA INF MM		VM2353A0	TAPPO DX COPRI VITI STAFFA PORTA INF MM																													
VM1240A	TAPPO NYLON SUPPORTO CONTROSTAFFA		KVM1240A	KIT TAPPO SUPPORTO CONTROSTAFFA 4P	<table border="1"> <thead> <tr> <th>Codice</th> <th>Descrizione</th> <th>Qti</th> <th>UM</th> </tr> </thead> <tbody> <tr> <td>VM1240A0</td> <td>TAPPO NYLON SUPPORTO CONTROSTAF FA</td> <td>4</td> <td>PZ</td> </tr> </tbody> </table>	Codice	Descrizione	Qti	UM	VM1240A0	TAPPO NYLON SUPPORTO CONTROSTAF FA	4	PZ																				
Codice	Descrizione	Qti	UM																														
VM1240A0	TAPPO NYLON SUPPORTO CONTROSTAF FA	4	PZ																														
VM2273A	STAFFA INF PORTA MM SX		KVM2273A	KIT STAFFA INFERIORE PORTA MIND.MAPS SX	<table border="1"> <thead> <tr> <th>Codice</th> <th>Descrizione</th> <th>Qti</th> <th>UM</th> </tr> </thead> <tbody> <tr> <td>0H7330A0</td> <td>RONDELLA STAFFA INFERIORE PORTA MM</td> <td>2</td> <td>PZ</td> </tr> <tr> <td>V11995A0</td> <td>VITE M5X25 TCEI INOX</td> <td>4</td> <td>PZ</td> </tr> <tr> <td>VM2273A0</td> <td>STAFFA INF PORTA MM SX</td> <td>1</td> <td>PZ</td> </tr> <tr> <td>VM2273A1</td> <td>STAFFA INF PORTA MM SX</td> <td>1</td> <td>PZ</td> </tr> <tr> <td>VM2352A0</td> <td>TAPPO SX COPRI VITI STAFFA PORTA INF M</td> <td>2</td> <td>PZ</td> </tr> <tr> <td>VM2353A0</td> <td>TAPPO DX COPRI VITI STAFFA PORTA INF M</td> <td>1</td> <td>PZ</td> </tr> </tbody> </table>	Codice	Descrizione	Qti	UM	0H7330A0	RONDELLA STAFFA INFERIORE PORTA MM	2	PZ	V11995A0	VITE M5X25 TCEI INOX	4	PZ	VM2273A0	STAFFA INF PORTA MM SX	1	PZ	VM2273A1	STAFFA INF PORTA MM SX	1	PZ	VM2352A0	TAPPO SX COPRI VITI STAFFA PORTA INF M	2	PZ	VM2353A0	TAPPO DX COPRI VITI STAFFA PORTA INF M	1	PZ
Codice	Descrizione	Qti	UM																														
0H7330A0	RONDELLA STAFFA INFERIORE PORTA MM	2	PZ																														
V11995A0	VITE M5X25 TCEI INOX	4	PZ																														
VM2273A0	STAFFA INF PORTA MM SX	1	PZ																														
VM2273A1	STAFFA INF PORTA MM SX	1	PZ																														
VM2352A0	TAPPO SX COPRI VITI STAFFA PORTA INF M	2	PZ																														
VM2353A0	TAPPO DX COPRI VITI STAFFA PORTA INF M	1	PZ																														



COMPONENTE			RICAMBIO																										
Codice	Descrizione	Immagine	Codice	Descrizione	Lista componenti																								
0H7675A	CONTROSTAFFA PORTA SERIE 6																												
0H2561A	CONTROSTAFFA PORTA MM		0H2561A0	CONTROSTAFFA PORTA MM																									
VM1240A	TAPPO NYLON SUPPORTO CONTROSTAFFA		KVM1240A	KIT TAPPO SUPPORTO CONTROSTAFFA 4P	<table border="1"> <thead> <tr> <th>Codice</th> <th>Descrizione</th> <th>Qtà</th> <th>UM</th> </tr> </thead> <tbody> <tr> <td>VM1240A0</td> <td>TAPPO NYLON SUPPORTO CONTROSTAF FA</td> <td>4</td> <td>PZ</td> </tr> </tbody> </table>	Codice	Descrizione	Qtà	UM	VM1240A0	TAPPO NYLON SUPPORTO CONTROSTAF FA	4	PZ																
Codice	Descrizione	Qtà	UM																										
VM1240A0	TAPPO NYLON SUPPORTO CONTROSTAF FA	4	PZ																										
VM2298A	COPERCHIO SUP STAFFA PORTA MM		KVM2298A	KIT COPERCHIO SUP STAFFA PORTA MIND MAPS	<table border="1"> <thead> <tr> <th>Codice</th> <th>Descrizione</th> <th>Qtà</th> <th>UM</th> </tr> </thead> <tbody> <tr> <td>VI1220A0</td> <td>VITE AUTOFIL. 4.2X12 TCB MARUTEX PREMAGN</td> <td>2</td> <td>PZ</td> </tr> <tr> <td>VM2298A0</td> <td>COPERCHIO SUP STAFFA PORTA MM</td> <td>1</td> <td>PZ</td> </tr> </tbody> </table>	Codice	Descrizione	Qtà	UM	VI1220A0	VITE AUTOFIL. 4.2X12 TCB MARUTEX PREMAGN	2	PZ	VM2298A0	COPERCHIO SUP STAFFA PORTA MM	1	PZ												
Codice	Descrizione	Qtà	UM																										
VI1220A0	VITE AUTOFIL. 4.2X12 TCB MARUTEX PREMAGN	2	PZ																										
VM2298A0	COPERCHIO SUP STAFFA PORTA MM	1	PZ																										
VM2271A	STAFFA SUP PORTA MM SX		KVM2271A	KIT STAFFA SUPERIORE PORTA MIND.MAPS SX	<table border="1"> <thead> <tr> <th>Codice</th> <th>Descrizione</th> <th>Qtà</th> <th>UM</th> </tr> </thead> <tbody> <tr> <td>VI1220A1</td> <td>VITE AUTOFILETTA NTE 4.2X11 TCS+ MARUTE</td> <td>2</td> <td>PZ</td> </tr> <tr> <td>VI1995A0</td> <td>VITE M5X25 TCEI INOX</td> <td>4</td> <td>PZ</td> </tr> <tr> <td>VI1997A0</td> <td>RONDELLA PIANA 5X10X1 ZN</td> <td>4</td> <td>PZ</td> </tr> <tr> <td>VM2271A0</td> <td>STAFFA SUP PORTA MM SX</td> <td>1</td> <td>PZ</td> </tr> <tr> <td>VM2298A0</td> <td>COPERCHIO SUP STAFFA PORTA MM</td> <td>1</td> <td>PZ</td> </tr> </tbody> </table>	Codice	Descrizione	Qtà	UM	VI1220A1	VITE AUTOFILETTA NTE 4.2X11 TCS+ MARUTE	2	PZ	VI1995A0	VITE M5X25 TCEI INOX	4	PZ	VI1997A0	RONDELLA PIANA 5X10X1 ZN	4	PZ	VM2271A0	STAFFA SUP PORTA MM SX	1	PZ	VM2298A0	COPERCHIO SUP STAFFA PORTA MM	1	PZ
Codice	Descrizione	Qtà	UM																										
VI1220A1	VITE AUTOFILETTA NTE 4.2X11 TCS+ MARUTE	2	PZ																										
VI1995A0	VITE M5X25 TCEI INOX	4	PZ																										
VI1997A0	RONDELLA PIANA 5X10X1 ZN	4	PZ																										
VM2271A0	STAFFA SUP PORTA MM SX	1	PZ																										
VM2298A0	COPERCHIO SUP STAFFA PORTA MM	1	PZ																										





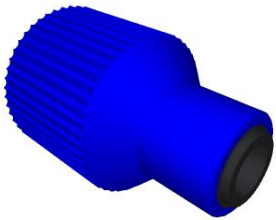

COMPONENTE			RICAMBIO										
Codice	Descrizione	Immagine	Codice	Descrizione	Lista componenti								
0H7675A	CONTROSTAFFA PORTA SERIE 6												
0H2561A	CONTROSTAFFA PORTA MM		0H2561A0	CONTROSTAFFA PORTA MM									
VM1240A	TAPPO NYLON SUPPORTO CONTROSTAFFA		KVM1240A	KIT TAPPO SUPPORTO CONTROSTAFFA 4P	<table border="1"> <thead> <tr> <th>Codice</th> <th>Descrizione</th> <th>Qta</th> <th>UM</th> </tr> </thead> <tbody> <tr> <td>VM1240A0</td> <td>TAPPO NYLON SUPPORTO CONTROSTAF FA</td> <td>4</td> <td>PZ</td> </tr> </tbody> </table>	Codice	Descrizione	Qta	UM	VM1240A0	TAPPO NYLON SUPPORTO CONTROSTAF FA	4	PZ
Codice	Descrizione	Qta	UM										
VM1240A0	TAPPO NYLON SUPPORTO CONTROSTAF FA	4	PZ										
VM2310A	PIASTRINA A L COPRI FORI STAFFA SUP		KVM2310A	KIT PIASTRINA A L COPRI FORI STAFFA SUP	<table border="1"> <thead> <tr> <th>Codice</th> <th>Descrizione</th> <th>Qta</th> <th>UM</th> </tr> </thead> <tbody> <tr> <td>VM2310A0</td> <td>PIASTRINA A L COPRI FORI STAFFA SUP</td> <td>1</td> <td>PZ</td> </tr> </tbody> </table>	Codice	Descrizione	Qta	UM	VM2310A0	PIASTRINA A L COPRI FORI STAFFA SUP	1	PZ
Codice	Descrizione	Qta	UM										
VM2310A0	PIASTRINA A L COPRI FORI STAFFA SUP	1	PZ										
0H7675A	CONTROSTAFFA PORTA SERIE 6												



COMPONENTE			RICAMBIO																										
Codice	Descrizione	Immagine	Codice	Descrizione	Lista componenti																								
0H1019A	LAMIERA RINFORZO PIEDI H100 CT		K0H1019A	KIT LAMIERA RINFORZO PIEDI H100 CT	<table border="1"> <thead> <tr> <th>Codice</th> <th>Descrizione</th> <th>Qtà</th> <th>UM</th> </tr> </thead> <tbody> <tr> <td>0H1019A1</td> <td>LAMIERA RINFORZO PIEDI H100 CT</td> <td>1</td> <td>PZ</td> </tr> <tr> <td>0H1019A2</td> <td>LAMIERA RINFORZO PIEDI H100 CT</td> <td>1</td> <td>PZ</td> </tr> <tr> <td>VI1737A0</td> <td>INSERTO FILETTATO M10 FTT/C INO</td> <td>2</td> <td>PZ</td> </tr> <tr> <td>VI1739A0</td> <td>INSERTO FILETTATO M10 FTT/E ZN STP</td> <td>2</td> <td>PZ</td> </tr> <tr> <td>VM1106A0</td> <td>TAPPO IMBALLO TUBO DI120</td> <td>2</td> <td>PZ</td> </tr> </tbody> </table>	Codice	Descrizione	Qtà	UM	0H1019A1	LAMIERA RINFORZO PIEDI H100 CT	1	PZ	0H1019A2	LAMIERA RINFORZO PIEDI H100 CT	1	PZ	VI1737A0	INSERTO FILETTATO M10 FTT/C INO	2	PZ	VI1739A0	INSERTO FILETTATO M10 FTT/E ZN STP	2	PZ	VM1106A0	TAPPO IMBALLO TUBO DI120	2	PZ
Codice	Descrizione	Qtà	UM																										
0H1019A1	LAMIERA RINFORZO PIEDI H100 CT	1	PZ																										
0H1019A2	LAMIERA RINFORZO PIEDI H100 CT	1	PZ																										
VI1737A0	INSERTO FILETTATO M10 FTT/C INO	2	PZ																										
VI1739A0	INSERTO FILETTATO M10 FTT/E ZN STP	2	PZ																										
VM1106A0	TAPPO IMBALLO TUBO DI120	2	PZ																										
PD1074A	PIEDE H100 BICOMPONENTE QUADRO		KPD1074A	KIT PIEDINO H100 PD1074A0	<table border="1"> <thead> <tr> <th>Codice</th> <th>Descrizione</th> <th>Qtà</th> <th>UM</th> </tr> </thead> <tbody> <tr> <td>PD1074A0</td> <td>PIEDE H100 BICOMPONEN TE QUADRO</td> <td>1</td> <td>PZ</td> </tr> <tr> <td>PD1075A0</td> <td>STAFFA BLOCCAGGIO PIEDE PD1074</td> <td>1</td> <td>PZ</td> </tr> <tr> <td>VI1220A1</td> <td>VITE AUTOFILETTA NTE 4.2X11 TCS+ MARUTE</td> <td>5</td> <td>PZ</td> </tr> </tbody> </table>	Codice	Descrizione	Qtà	UM	PD1074A0	PIEDE H100 BICOMPONEN TE QUADRO	1	PZ	PD1075A0	STAFFA BLOCCAGGIO PIEDE PD1074	1	PZ	VI1220A1	VITE AUTOFILETTA NTE 4.2X11 TCS+ MARUTE	5	PZ								
Codice	Descrizione	Qtà	UM																										
PD1074A0	PIEDE H100 BICOMPONEN TE QUADRO	1	PZ																										
PD1075A0	STAFFA BLOCCAGGIO PIEDE PD1074	1	PZ																										
VI1220A1	VITE AUTOFILETTA NTE 4.2X11 TCS+ MARUTE	5	PZ																										
PD1075A	STAFFA BLOCCAGGIO PIEDE PD1074		KPD1075A	KIT STAFFA BLOCCAGGIO PIEDE PD1074A0	<table border="1"> <thead> <tr> <th>Codice</th> <th>Descrizione</th> <th>Qtà</th> <th>UM</th> </tr> </thead> <tbody> <tr> <td>PD1075A0</td> <td>STAFFA BLOCCAGGIO PIEDE PD1074</td> <td>4</td> <td>PZ</td> </tr> <tr> <td>VI1950A0</td> <td>VITE AUTOFORANT E 4,2X13 TCB INOX</td> <td>8</td> <td>PZ</td> </tr> </tbody> </table>	Codice	Descrizione	Qtà	UM	PD1075A0	STAFFA BLOCCAGGIO PIEDE PD1074	4	PZ	VI1950A0	VITE AUTOFORANT E 4,2X13 TCB INOX	8	PZ												
Codice	Descrizione	Qtà	UM																										
PD1075A0	STAFFA BLOCCAGGIO PIEDE PD1074	4	PZ																										
VI1950A0	VITE AUTOFORANT E 4,2X13 TCB INOX	8	PZ																										
0D2298A	FIANCO SX XEVC-0511																												

COMPONENTE			RICAMBIO																										
Codice	Descrizione	Immagine	Codice	Descrizione	Lista componenti																								
0D2299A	FIANCO DX XEVC-0511																												
VM2061A	PASSAPARETE CAVI ACCESSORI COMPLETO		KVM1505A	KIT PASSAPARETE CON DIAFRAMMA	<table border="1"> <thead> <tr> <th>Codice</th> <th>Descrizione</th> <th>Qtà</th> <th>UM</th> </tr> </thead> <tbody> <tr> <td>VI1220A1</td> <td>VITE AUTOFILETTA NTE 4.2X11 TCS+ MARUTE</td> <td>1</td> <td>PZ</td> </tr> <tr> <td>VM1505A0</td> <td>PASSAPARET E CON DIAFRAMMA</td> <td>3</td> <td>PZ</td> </tr> <tr> <td>VM2055A0</td> <td>PASSAPARET E CAVI ACCESSORI SUP.</td> <td>1</td> <td>PZ</td> </tr> <tr> <td>VM2056A0</td> <td>PASSAPARET E CAVI ACCESSORI INF.</td> <td>1</td> <td>PZ</td> </tr> <tr> <td>VM2061A0</td> <td>PASSAPARET E CAVI ACCESSORI COMPLETO</td> <td>1</td> <td>PZ</td> </tr> </tbody> </table>	Codice	Descrizione	Qtà	UM	VI1220A1	VITE AUTOFILETTA NTE 4.2X11 TCS+ MARUTE	1	PZ	VM1505A0	PASSAPARET E CON DIAFRAMMA	3	PZ	VM2055A0	PASSAPARET E CAVI ACCESSORI SUP.	1	PZ	VM2056A0	PASSAPARET E CAVI ACCESSORI INF.	1	PZ	VM2061A0	PASSAPARET E CAVI ACCESSORI COMPLETO	1	PZ
Codice	Descrizione	Qtà	UM																										
VI1220A1	VITE AUTOFILETTA NTE 4.2X11 TCS+ MARUTE	1	PZ																										
VM1505A0	PASSAPARET E CON DIAFRAMMA	3	PZ																										
VM2055A0	PASSAPARET E CAVI ACCESSORI SUP.	1	PZ																										
VM2056A0	PASSAPARET E CAVI ACCESSORI INF.	1	PZ																										
VM2061A0	PASSAPARET E CAVI ACCESSORI COMPLETO	1	PZ																										
0D2295A	COPERCHIO XEVC GN1-1		0D2295A0	COPERCHIO XEVC GN1-1																									
0E1350B	FONDO ESTERNO XEVC GN1-1																												

COMPONENTE			RICAMBIO																																										
Codice	Descrizione	Immagine	Codice	Descrizione	Lista componenti																																								
RC1365A	RACCORDO JG FEMMINA 3/4"-10		KRC1365A	KIT RICAMBIO ATTACCO ACQUA DI RETE	<table border="1"> <thead> <tr> <th>Codice</th> <th>Descrizione</th> <th>Qtà</th> <th>UM</th> </tr> </thead> <tbody> <tr> <td>GN1200A1</td> <td>GUARNIZIONE D24 RACCORDO 3/4 SILICONE</td> <td>1</td> <td>PZ</td> </tr> <tr> <td>RC1002A0</td> <td>RACCORDO RIDUZIONE CODOLO 10M-8F</td> <td>1</td> <td>PZ</td> </tr> <tr> <td>RC1365A0</td> <td>RACCORDO JG FEMMINA 3/4"-10</td> <td>1</td> <td>PZ</td> </tr> </tbody> </table>	Codice	Descrizione	Qtà	UM	GN1200A1	GUARNIZIONE D24 RACCORDO 3/4 SILICONE	1	PZ	RC1002A0	RACCORDO RIDUZIONE CODOLO 10M-8F	1	PZ	RC1365A0	RACCORDO JG FEMMINA 3/4"-10	1	PZ																								
Codice	Descrizione	Qtà	UM																																										
GN1200A1	GUARNIZIONE D24 RACCORDO 3/4 SILICONE	1	PZ																																										
RC1002A0	RACCORDO RIDUZIONE CODOLO 10M-8F	1	PZ																																										
RC1365A0	RACCORDO JG FEMMINA 3/4"-10	1	PZ																																										
VL1086A	MAGNETE NEODIMIO ANTICALCARE		KVL1086A	KIT MAGNETE NEODIMIO ANTICALCARE	<table border="1"> <thead> <tr> <th>Codice</th> <th>Descrizione</th> <th>Qtà</th> <th>UM</th> </tr> </thead> <tbody> <tr> <td>VL1086A0</td> <td>MAGNETE NEODIMIO ANTICALCARE</td> <td>2</td> <td>PZ</td> </tr> </tbody> </table>	Codice	Descrizione	Qtà	UM	VL1086A0	MAGNETE NEODIMIO ANTICALCARE	2	PZ																																
Codice	Descrizione	Qtà	UM																																										
VL1086A0	MAGNETE NEODIMIO ANTICALCARE	2	PZ																																										
VM1054A	GHIERA RIDUTTORE DI PRESSIONE H7.8		KVM1054A  KVL1117A	KIT GHIERA RIDUTTORE DI PRESSIONE  KIT FILTRO+RID. PRESS. EUR MM 2016+LMTOP	<table border="1"> <thead> <tr> <th>Codice</th> <th>Descrizione</th> <th>Qtà</th> <th>UM</th> </tr> </thead> <tbody> <tr> <td>VM1054A0</td> <td>GHIERA RIDUTTORE DI PRESSIONE H7.8</td> <td>1</td> <td>PZ</td> </tr> </tbody> </table> <table border="1"> <thead> <tr> <th>Codice</th> <th>Descrizione</th> <th>Qtà</th> <th>UM</th> </tr> </thead> <tbody> <tr> <td>0H7472A1</td> <td>LAMIERA SUPPORTO DISTRIBUTOR</td> <td>1</td> <td>PZ</td> </tr> <tr> <td>RC1004A0</td> <td>RACCORDO Y Ø10-Ø8-8</td> <td>1</td> <td>PZ</td> </tr> <tr> <td>RC1243A0</td> <td>RACCORDO GOMITO CODOLO Ø10F-Ø10M</td> <td>1</td> <td>PZ</td> </tr> <tr> <td>RC1372A0</td> <td>RACCORDO DRITTO Ø10M-1/4 M CI</td> <td>2</td> <td>PZ</td> </tr> <tr> <td>VI1013A1</td> <td>RONDELLA PIANA 30.5X39.5X3 NYLON</td> <td>1</td> <td>PZ</td> </tr> <tr> <td>VI1220A1</td> <td>VITE AUTOFILETTA NTE 4.2X11 TCS+ MARUTE</td> <td>2</td> <td>PZ</td> </tr> <tr> <td>VL1014A0</td> <td>RIDUTTORE DI PRESSIONE CON DISTRIBUTOR</td> <td>1</td> <td>PZ</td> </tr> </tbody> </table>	Codice	Descrizione	Qtà	UM	VM1054A0	GHIERA RIDUTTORE DI PRESSIONE H7.8	1	PZ	Codice	Descrizione	Qtà	UM	0H7472A1	LAMIERA SUPPORTO DISTRIBUTOR	1	PZ	RC1004A0	RACCORDO Y Ø10-Ø8-8	1	PZ	RC1243A0	RACCORDO GOMITO CODOLO Ø10F-Ø10M	1	PZ	RC1372A0	RACCORDO DRITTO Ø10M-1/4 M CI	2	PZ	VI1013A1	RONDELLA PIANA 30.5X39.5X3 NYLON	1	PZ	VI1220A1	VITE AUTOFILETTA NTE 4.2X11 TCS+ MARUTE	2	PZ	VL1014A0	RIDUTTORE DI PRESSIONE CON DISTRIBUTOR	1	PZ
Codice	Descrizione	Qtà	UM																																										
VM1054A0	GHIERA RIDUTTORE DI PRESSIONE H7.8	1	PZ																																										
Codice	Descrizione	Qtà	UM																																										
0H7472A1	LAMIERA SUPPORTO DISTRIBUTOR	1	PZ																																										
RC1004A0	RACCORDO Y Ø10-Ø8-8	1	PZ																																										
RC1243A0	RACCORDO GOMITO CODOLO Ø10F-Ø10M	1	PZ																																										
RC1372A0	RACCORDO DRITTO Ø10M-1/4 M CI	2	PZ																																										
VI1013A1	RONDELLA PIANA 30.5X39.5X3 NYLON	1	PZ																																										
VI1220A1	VITE AUTOFILETTA NTE 4.2X11 TCS+ MARUTE	2	PZ																																										
VL1014A0	RIDUTTORE DI PRESSIONE CON DISTRIBUTOR	1	PZ																																										

COMPONENTE			RICAMBIO																																																						
Codice	Descrizione	Immagine	Codice	Descrizione	Lista componenti																																																				
VM1054A	GHIERA RIDUTTORE DI PRESSIONE H7.8		KVL1117A	KIT FILTRO+RID. PRESS. EUR MM 2016+LMTOP	<table border="1"> <thead> <tr> <th>Codice</th> <th>Descrizione</th> <th>Qtà</th> <th>UM</th> </tr> </thead> <tbody> <tr> <td>VL1014B0</td> <td>RIDUTTORE DI PRESSIONE CON DISTRIBUTOR</td> <td>1</td> <td>PZ</td> </tr> <tr> <td>VL1034C0</td> <td>FILTRO ACQUA D10 MESH100</td> <td>1</td> <td>PZ</td> </tr> <tr> <td>VL1062C0</td> <td>FORCELLA BLOCCA FILTRO-RIDUTTORE PRES.</td> <td>1</td> <td>PZ</td> </tr> <tr> <td>VM1053A0</td> <td>TAPPO 1/8" CIL CON O-RIN</td> <td>2</td> <td>PZ</td> </tr> <tr> <td>VM1054A0</td> <td>GHIERA RIDUTTORE DI PRESSIONE H7.8</td> <td>1</td> <td>PZ</td> </tr> </tbody> </table>	Codice	Descrizione	Qtà	UM	VL1014B0	RIDUTTORE DI PRESSIONE CON DISTRIBUTOR	1	PZ	VL1034C0	FILTRO ACQUA D10 MESH100	1	PZ	VL1062C0	FORCELLA BLOCCA FILTRO-RIDUTTORE PRES.	1	PZ	VM1053A0	TAPPO 1/8" CIL CON O-RIN	2	PZ	VM1054A0	GHIERA RIDUTTORE DI PRESSIONE H7.8	1	PZ																												
Codice	Descrizione	Qtà	UM																																																						
VL1014B0	RIDUTTORE DI PRESSIONE CON DISTRIBUTOR	1	PZ																																																						
VL1034C0	FILTRO ACQUA D10 MESH100	1	PZ																																																						
VL1062C0	FORCELLA BLOCCA FILTRO-RIDUTTORE PRES.	1	PZ																																																						
VM1053A0	TAPPO 1/8" CIL CON O-RIN	2	PZ																																																						
VM1054A0	GHIERA RIDUTTORE DI PRESSIONE H7.8	1	PZ																																																						
VL1034C	FILTRO ACQUA D10 MESH100		KVL1117A	KIT FILTRO+RID. PRESS. EUR MM 2016+LMTOP	<table border="1"> <thead> <tr> <th>Codice</th> <th>Descrizione</th> <th>Qtà</th> <th>UM</th> </tr> </thead> <tbody> <tr> <td>0H7472A1</td> <td>LAMIERA SUPPORTO DISTRIBUTOR</td> <td>1</td> <td>PZ</td> </tr> <tr> <td>RC1004A0</td> <td>RACCORDO Y Ø10-Ø8-8</td> <td>1</td> <td>PZ</td> </tr> <tr> <td>RC1243A0</td> <td>RACCORDO GOMITO CODOLO Ø10F-Ø10M</td> <td>1</td> <td>PZ</td> </tr> <tr> <td>RC1372A0</td> <td>RACCORDO DRITTO Ø10M-1/4 M.CI</td> <td>2</td> <td>PZ</td> </tr> <tr> <td>VI1013A1</td> <td>RONDELLA PIANA 30.5X39.5X3 NYLON</td> <td>1</td> <td>PZ</td> </tr> <tr> <td>VI1220A1</td> <td>VITE AUTOFILETTA NTE 4.2X11 TCS+ MARUTE</td> <td>2</td> <td>PZ</td> </tr> <tr> <td>VL1014A0</td> <td>RIDUTTORE DI PRESSIONE CON DISTRIBUTOR</td> <td>1</td> <td>PZ</td> </tr> <tr> <td>VL1014B0</td> <td>RIDUTTORE DI PRESSIONE CON DISTRIBUTOR</td> <td>1</td> <td>PZ</td> </tr> <tr> <td>VL1034C0</td> <td>FILTRO ACQUA D10 MESH100</td> <td>1</td> <td>PZ</td> </tr> <tr> <td>VL1062C0</td> <td>FORCELLA BLOCCA FILTRO-RIDUTTORE PRES.</td> <td>1</td> <td>PZ</td> </tr> <tr> <td>VM1053A0</td> <td>TAPPO 1/8" CIL CON O-RIN</td> <td>2</td> <td>PZ</td> </tr> <tr> <td>VM1054A0</td> <td>GHIERA RIDUTTORE DI PRESSIONE H7.8</td> <td>1</td> <td>PZ</td> </tr> </tbody> </table>	Codice	Descrizione	Qtà	UM	0H7472A1	LAMIERA SUPPORTO DISTRIBUTOR	1	PZ	RC1004A0	RACCORDO Y Ø10-Ø8-8	1	PZ	RC1243A0	RACCORDO GOMITO CODOLO Ø10F-Ø10M	1	PZ	RC1372A0	RACCORDO DRITTO Ø10M-1/4 M.CI	2	PZ	VI1013A1	RONDELLA PIANA 30.5X39.5X3 NYLON	1	PZ	VI1220A1	VITE AUTOFILETTA NTE 4.2X11 TCS+ MARUTE	2	PZ	VL1014A0	RIDUTTORE DI PRESSIONE CON DISTRIBUTOR	1	PZ	VL1014B0	RIDUTTORE DI PRESSIONE CON DISTRIBUTOR	1	PZ	VL1034C0	FILTRO ACQUA D10 MESH100	1	PZ	VL1062C0	FORCELLA BLOCCA FILTRO-RIDUTTORE PRES.	1	PZ	VM1053A0	TAPPO 1/8" CIL CON O-RIN	2	PZ	VM1054A0	GHIERA RIDUTTORE DI PRESSIONE H7.8	1	PZ
Codice	Descrizione	Qtà	UM																																																						
0H7472A1	LAMIERA SUPPORTO DISTRIBUTOR	1	PZ																																																						
RC1004A0	RACCORDO Y Ø10-Ø8-8	1	PZ																																																						
RC1243A0	RACCORDO GOMITO CODOLO Ø10F-Ø10M	1	PZ																																																						
RC1372A0	RACCORDO DRITTO Ø10M-1/4 M.CI	2	PZ																																																						
VI1013A1	RONDELLA PIANA 30.5X39.5X3 NYLON	1	PZ																																																						
VI1220A1	VITE AUTOFILETTA NTE 4.2X11 TCS+ MARUTE	2	PZ																																																						
VL1014A0	RIDUTTORE DI PRESSIONE CON DISTRIBUTOR	1	PZ																																																						
VL1014B0	RIDUTTORE DI PRESSIONE CON DISTRIBUTOR	1	PZ																																																						
VL1034C0	FILTRO ACQUA D10 MESH100	1	PZ																																																						
VL1062C0	FORCELLA BLOCCA FILTRO-RIDUTTORE PRES.	1	PZ																																																						
VM1053A0	TAPPO 1/8" CIL CON O-RIN	2	PZ																																																						
VM1054A0	GHIERA RIDUTTORE DI PRESSIONE H7.8	1	PZ																																																						

COMPONENTE			RICAMBIO																																																						
Codice	Descrizione	Immagine	Codice	Descrizione	Lista componenti																																																				
VL1034C	FILTRO ACQUA D10 MESH100		KVL1034C	KIT RICAMBIO FILTRO ACQUA Ø8-Ø10 MESH100	<table border="1"> <thead> <tr> <th>Codice</th> <th>Descrizione</th> <th>Qtà</th> <th>UM</th> </tr> </thead> <tbody> <tr> <td>RC1002A0</td> <td>RACCORDO RIDUZIONE CODOLO 10M-8F</td> <td>2</td> <td>PZ</td> </tr> <tr> <td>VL1034C0</td> <td>FILTRO ACQUA D10 MESH100</td> <td>1</td> <td>PZ</td> </tr> <tr> <td>VL1062C0</td> <td>FORCELLA BLOCCA FILTRO-RIDUT TORE PRES.</td> <td>1</td> <td>PZ</td> </tr> </tbody> </table>	Codice	Descrizione	Qtà	UM	RC1002A0	RACCORDO RIDUZIONE CODOLO 10M-8F	2	PZ	VL1034C0	FILTRO ACQUA D10 MESH100	1	PZ	VL1062C0	FORCELLA BLOCCA FILTRO-RIDUT TORE PRES.	1	PZ																																				
Codice	Descrizione	Qtà	UM																																																						
RC1002A0	RACCORDO RIDUZIONE CODOLO 10M-8F	2	PZ																																																						
VL1034C0	FILTRO ACQUA D10 MESH100	1	PZ																																																						
VL1062C0	FORCELLA BLOCCA FILTRO-RIDUT TORE PRES.	1	PZ																																																						
VL1062C	FORCELLA BLOCCA FILTRO-RIDUTTORE PRES.		KVL1117A	KIT FILTRO+RID. PRESS. EUR MM 2016+LMTOP	<table border="1"> <thead> <tr> <th>Codice</th> <th>Descrizione</th> <th>Qtà</th> <th>UM</th> </tr> </thead> <tbody> <tr> <td>0H7472A1</td> <td>LAMIERA SUPPORTO DISTRIBUTOR</td> <td>1</td> <td>PZ</td> </tr> <tr> <td>RC1004A0</td> <td>RACCORDO Y Ø10-Ø8-8</td> <td>1</td> <td>PZ</td> </tr> <tr> <td>RC1243A0</td> <td>RACCORDO GOMITO CODOLO Ø10F-Ø10M</td> <td>1</td> <td>PZ</td> </tr> <tr> <td>RC1372A0</td> <td>RACCORDO DRITTO Ø10M-1/4 M.CI</td> <td>2</td> <td>PZ</td> </tr> <tr> <td>VI1013A1</td> <td>RONDELLA PIANA 30.5X39.5X3 NYLON</td> <td>1</td> <td>PZ</td> </tr> <tr> <td>VI1220A1</td> <td>VITE AUTOFILETTA NTE 4.2X11 TCS+ MARUTE</td> <td>2</td> <td>PZ</td> </tr> <tr> <td>VL1014A0</td> <td>RIDUTTORE DI PRESSIONE CON DISTRIBUTOR</td> <td>1</td> <td>PZ</td> </tr> <tr> <td>VL1014B0</td> <td>RIDUTTORE DI PRESSIONE CON DISTRIBUTOR</td> <td>1</td> <td>PZ</td> </tr> <tr> <td>VL1034C0</td> <td>FILTRO ACQUA D10 MESH100</td> <td>1</td> <td>PZ</td> </tr> <tr> <td>VL1062C0</td> <td>FORCELLA BLOCCA FILTRO-RIDUT TORE PRES.</td> <td>1</td> <td>PZ</td> </tr> <tr> <td>VM1053A0</td> <td>TAPPO 1/8" CIL CON O-RIN</td> <td>2</td> <td>PZ</td> </tr> <tr> <td>VM1054A0</td> <td>GHIERA RIDUTTORE DI PRESSIONE H7.8</td> <td>1</td> <td>PZ</td> </tr> </tbody> </table>	Codice	Descrizione	Qtà	UM	0H7472A1	LAMIERA SUPPORTO DISTRIBUTOR	1	PZ	RC1004A0	RACCORDO Y Ø10-Ø8-8	1	PZ	RC1243A0	RACCORDO GOMITO CODOLO Ø10F-Ø10M	1	PZ	RC1372A0	RACCORDO DRITTO Ø10M-1/4 M.CI	2	PZ	VI1013A1	RONDELLA PIANA 30.5X39.5X3 NYLON	1	PZ	VI1220A1	VITE AUTOFILETTA NTE 4.2X11 TCS+ MARUTE	2	PZ	VL1014A0	RIDUTTORE DI PRESSIONE CON DISTRIBUTOR	1	PZ	VL1014B0	RIDUTTORE DI PRESSIONE CON DISTRIBUTOR	1	PZ	VL1034C0	FILTRO ACQUA D10 MESH100	1	PZ	VL1062C0	FORCELLA BLOCCA FILTRO-RIDUT TORE PRES.	1	PZ	VM1053A0	TAPPO 1/8" CIL CON O-RIN	2	PZ	VM1054A0	GHIERA RIDUTTORE DI PRESSIONE H7.8	1	PZ
Codice	Descrizione	Qtà	UM																																																						
0H7472A1	LAMIERA SUPPORTO DISTRIBUTOR	1	PZ																																																						
RC1004A0	RACCORDO Y Ø10-Ø8-8	1	PZ																																																						
RC1243A0	RACCORDO GOMITO CODOLO Ø10F-Ø10M	1	PZ																																																						
RC1372A0	RACCORDO DRITTO Ø10M-1/4 M.CI	2	PZ																																																						
VI1013A1	RONDELLA PIANA 30.5X39.5X3 NYLON	1	PZ																																																						
VI1220A1	VITE AUTOFILETTA NTE 4.2X11 TCS+ MARUTE	2	PZ																																																						
VL1014A0	RIDUTTORE DI PRESSIONE CON DISTRIBUTOR	1	PZ																																																						
VL1014B0	RIDUTTORE DI PRESSIONE CON DISTRIBUTOR	1	PZ																																																						
VL1034C0	FILTRO ACQUA D10 MESH100	1	PZ																																																						
VL1062C0	FORCELLA BLOCCA FILTRO-RIDUT TORE PRES.	1	PZ																																																						
VM1053A0	TAPPO 1/8" CIL CON O-RIN	2	PZ																																																						
VM1054A0	GHIERA RIDUTTORE DI PRESSIONE H7.8	1	PZ																																																						

COMPONENTE			RICAMBIO																														
Codice	Descrizione	Immagine	Codice	Descrizione	Lista componenti																												
VL1125A	RACCORDO CURVO M-M PORTAGOMMA D8- CODOLO		KVL1125A	KIT 10PZ RAC CURVO M-M PORTAG D8-COD D1	<table border="1"> <thead> <tr> <th>Codice</th> <th>Descrizione</th> <th>Qtà</th> <th>UM</th> </tr> </thead> <tbody> <tr> <td>VL1125A0</td> <td>RACCORDO CURVO M-M PORTAGOMM A D8- CODOLO</td> <td>10</td> <td>PZ</td> </tr> <tr> <td>VL1125A1</td> <td>RACCORDO CURVO M-M PORTAGOMM A D8- CODOLO</td> <td>10</td> <td>PZ</td> </tr> </tbody> </table>	Codice	Descrizione	Qtà	UM	VL1125A0	RACCORDO CURVO M-M PORTAGOMM A D8- CODOLO	10	PZ	VL1125A1	RACCORDO CURVO M-M PORTAGOMM A D8- CODOLO	10	PZ																
			Codice	Descrizione	Qtà	UM																											
VL1125A0	RACCORDO CURVO M-M PORTAGOMM A D8- CODOLO	10	PZ																														
VL1125A1	RACCORDO CURVO M-M PORTAGOMM A D8- CODOLO	10	PZ																														
KTB2237A	KIT TB2243A D10 ALLACCIAMENTO	<table border="1"> <thead> <tr> <th>Codice</th> <th>Descrizione</th> <th>Qtà</th> <th>UM</th> </tr> </thead> <tbody> <tr> <td>TB2243A0</td> <td>TUBO PET Ø10</td> <td>1.500</td> <td>M</td> </tr> </tbody> </table>	Codice	Descrizione	Qtà	UM	TB2243A0	TUBO PET Ø10	1.500	M																							
Codice	Descrizione	Qtà	UM																														
TB2243A0	TUBO PET Ø10	1.500	M																														
VL1071A	RIDUTTORE DI PRESSIONE CON DISTRIBUTORE		KVL1071A	RETE 1,5M KIT RIDUTTORE DI PRESSIONE USA 5E	<table border="1"> <thead> <tr> <th>Codice</th> <th>Descrizione</th> <th>Qtà</th> <th>UM</th> </tr> </thead> <tbody> <tr> <td>RC1003A0</td> <td>RACCORDO 8M-1/8 BSPP</td> <td>2</td> <td>PZ</td> </tr> <tr> <td>RC1372A0</td> <td>RACCORDO DRITTO Ø10M-1/4 M CI</td> <td>1</td> <td>PZ</td> </tr> <tr> <td>VL1014A0</td> <td>RIDUTTORE DI PRESSIONE CON DISTRIBUTOR</td> <td>1</td> <td>PZ</td> </tr> <tr> <td>VL1071A0</td> <td>RIDUTTORE DI PRESSIONE CON DISTRIBUTOR</td> <td>1</td> <td>PZ</td> </tr> <tr> <td>VM2028A0</td> <td>RONDELLA GOMMA 20X10X4</td> <td>1</td> <td>PZ</td> </tr> <tr> <td>VM2059A0</td> <td>TAPPO 1/4" CIL CON O-RING*</td> <td>1</td> <td>PZ</td> </tr> </tbody> </table>	Codice	Descrizione	Qtà	UM	RC1003A0	RACCORDO 8M-1/8 BSPP	2	PZ	RC1372A0	RACCORDO DRITTO Ø10M-1/4 M CI	1	PZ	VL1014A0	RIDUTTORE DI PRESSIONE CON DISTRIBUTOR	1	PZ	VL1071A0	RIDUTTORE DI PRESSIONE CON DISTRIBUTOR	1	PZ	VM2028A0	RONDELLA GOMMA 20X10X4	1	PZ	VM2059A0	TAPPO 1/4" CIL CON O-RING*	1	PZ
			Codice	Descrizione	Qtà	UM																											
			RC1003A0	RACCORDO 8M-1/8 BSPP	2	PZ																											
			RC1372A0	RACCORDO DRITTO Ø10M-1/4 M CI	1	PZ																											
			VL1014A0	RIDUTTORE DI PRESSIONE CON DISTRIBUTOR	1	PZ																											
			VL1071A0	RIDUTTORE DI PRESSIONE CON DISTRIBUTOR	1	PZ																											
			VM2028A0	RONDELLA GOMMA 20X10X4	1	PZ																											
			VM2059A0	TAPPO 1/4" CIL CON O-RING*	1	PZ																											
			KVL1014A	KIT RIDUTTORE DI PRESSIONE 5E	<table border="1"> <thead> <tr> <th>Codice</th> <th>Descrizione</th> <th>Qtà</th> <th>UM</th> </tr> </thead> <tbody> <tr> <td>EL1185A0</td> <td>RACCORDO A GOMITO J.GUEST Ø8F - Ø8F</td> <td>1</td> <td>PZ</td> </tr> <tr> <td>EL1185B0</td> <td>RACCORDO GOMITO Ø8F-Ø8F</td> <td>1</td> <td>PZ</td> </tr> <tr> <td>RC1003A0</td> <td>RACCORDO 8M-1/8 BSPP</td> <td>2</td> <td>PZ</td> </tr> <tr> <td>RC1372A0</td> <td>RACCORDO DRITTO Ø10M-1/4 M CI</td> <td>1</td> <td>PZ</td> </tr> <tr> <td>VL1014A0</td> <td>RIDUTTORE DI PRESSIONE CON DISTRIBUTOR</td> <td>1</td> <td>PZ</td> </tr> </tbody> </table>	Codice	Descrizione	Qtà	UM	EL1185A0	RACCORDO A GOMITO J.GUEST Ø8F - Ø8F	1	PZ	EL1185B0	RACCORDO GOMITO Ø8F-Ø8F	1	PZ	RC1003A0	RACCORDO 8M-1/8 BSPP	2	PZ	RC1372A0	RACCORDO DRITTO Ø10M-1/4 M CI	1	PZ	VL1014A0	RIDUTTORE DI PRESSIONE CON DISTRIBUTOR	1	PZ				
			Codice	Descrizione	Qtà	UM																											
EL1185A0	RACCORDO A GOMITO J.GUEST Ø8F - Ø8F	1	PZ																														
EL1185B0	RACCORDO GOMITO Ø8F-Ø8F	1	PZ																														
RC1003A0	RACCORDO 8M-1/8 BSPP	2	PZ																														
RC1372A0	RACCORDO DRITTO Ø10M-1/4 M CI	1	PZ																														
VL1014A0	RIDUTTORE DI PRESSIONE CON DISTRIBUTOR	1	PZ																														



COMPONENTE			RICAMBIO																											
Codice	Descrizione	Immagine	Codice	Descrizione	Lista componenti																									
VL1071A	RIDUTTORE DI PRESSIONE CON DISTRIBUTORE		KVL1014A	KIT RIDUTTORE DI PRESSIONE 5E	<table border="1"> <thead> <tr> <th>Codice</th> <th>Descrizione</th> <th>Qtà</th> <th>UM</th> </tr> </thead> <tbody> <tr> <td>VL1071A0</td> <td>RIDUTTORE DI PRESSIONE CON DISTRIBUTOR</td> <td>1</td> <td>PZ</td> </tr> <tr> <td>VM2028A0</td> <td>RONDELLA GOMMA 20X10X4</td> <td>1</td> <td>PZ</td> </tr> <tr> <td>VM2059A0</td> <td>TAPPO 1/4" CIL CON O-RING*</td> <td>1</td> <td>PZ</td> </tr> </tbody> </table>	Codice	Descrizione	Qtà	UM	VL1071A0	RIDUTTORE DI PRESSIONE CON DISTRIBUTOR	1	PZ	VM2028A0	RONDELLA GOMMA 20X10X4	1	PZ	VM2059A0	TAPPO 1/4" CIL CON O-RING*	1	PZ									
			Codice	Descrizione	Qtà	UM																								
			VL1071A0	RIDUTTORE DI PRESSIONE CON DISTRIBUTOR	1	PZ																								
VM2028A0	RONDELLA GOMMA 20X10X4	1	PZ																											
VM2059A0	TAPPO 1/4" CIL CON O-RING*	1	PZ																											
KVL0071A	KIT RIDUTTORE DI PRESSIONE MM US	<table border="1"> <thead> <tr> <th>Codice</th> <th>Descrizione</th> <th>Qtà</th> <th>UM</th> </tr> </thead> <tbody> <tr> <td>RC1372A0</td> <td>RACCORDO DRITTO Ø10M-1/4 M.CI</td> <td>2</td> <td>PZ</td> </tr> <tr> <td>VI1013A1</td> <td>RONDELLA PIANA 30.5X39.5X3 NYLON</td> <td>1</td> <td>PZ</td> </tr> <tr> <td>VL1014A0</td> <td>RIDUTTORE DI PRESSIONE CON DISTRIBUTOR</td> <td>1</td> <td>PZ</td> </tr> <tr> <td>VL1071A0</td> <td>RIDUTTORE DI PRESSIONE CON DISTRIBUTOR</td> <td>1</td> <td>PZ</td> </tr> <tr> <td>VM1053A0</td> <td>TAPPO 1/8" CIL CON O-RIN</td> <td>2</td> <td>PZ</td> </tr> <tr> <td>VM1054A0</td> <td>GHIERA RIDUTTORE DI PRESSIONE H7.8</td> <td>1</td> <td>PZ</td> </tr> </tbody> </table>	Codice	Descrizione	Qtà	UM	RC1372A0	RACCORDO DRITTO Ø10M-1/4 M.CI	2	PZ	VI1013A1	RONDELLA PIANA 30.5X39.5X3 NYLON	1	PZ	VL1014A0	RIDUTTORE DI PRESSIONE CON DISTRIBUTOR	1	PZ	VL1071A0	RIDUTTORE DI PRESSIONE CON DISTRIBUTOR	1	PZ	VM1053A0	TAPPO 1/8" CIL CON O-RIN	2	PZ	VM1054A0	GHIERA RIDUTTORE DI PRESSIONE H7.8	1	PZ
Codice	Descrizione	Qtà	UM																											
RC1372A0	RACCORDO DRITTO Ø10M-1/4 M.CI	2	PZ																											
VI1013A1	RONDELLA PIANA 30.5X39.5X3 NYLON	1	PZ																											
VL1014A0	RIDUTTORE DI PRESSIONE CON DISTRIBUTOR	1	PZ																											
VL1071A0	RIDUTTORE DI PRESSIONE CON DISTRIBUTOR	1	PZ																											
VM1053A0	TAPPO 1/8" CIL CON O-RIN	2	PZ																											
VM1054A0	GHIERA RIDUTTORE DI PRESSIONE H7.8	1	PZ																											
KVL0014A	KIT RIDUTTORE DI PRESSIONE MIND.MAPS EUR	<table border="1"> <thead> <tr> <th>Codice</th> <th>Descrizione</th> <th>Qtà</th> <th>UM</th> </tr> </thead> <tbody> <tr> <td>RC1372A0</td> <td>RACCORDO DRITTO Ø10M-1/4 M.CI</td> <td>2</td> <td>PZ</td> </tr> <tr> <td>VL1014A0</td> <td>RIDUTTORE DI PRESSIONE CON DISTRIBUTOR</td> <td>1</td> <td>PZ</td> </tr> <tr> <td>VL1014B0</td> <td>RIDUTTORE DI PRESSIONE CON DISTRIBUTOR</td> <td>1</td> <td>PZ</td> </tr> <tr> <td>VM1053A0</td> <td>TAPPO 1/8" CIL CON O-RIN</td> <td>2</td> <td>PZ</td> </tr> <tr> <td>VM1054A0</td> <td>GHIERA RIDUTTORE DI PRESSIONE H7.8</td> <td>1</td> <td>PZ</td> </tr> </tbody> </table>	Codice	Descrizione	Qtà	UM	RC1372A0	RACCORDO DRITTO Ø10M-1/4 M.CI	2	PZ	VL1014A0	RIDUTTORE DI PRESSIONE CON DISTRIBUTOR	1	PZ	VL1014B0	RIDUTTORE DI PRESSIONE CON DISTRIBUTOR	1	PZ	VM1053A0	TAPPO 1/8" CIL CON O-RIN	2	PZ	VM1054A0	GHIERA RIDUTTORE DI PRESSIONE H7.8	1	PZ				
Codice	Descrizione	Qtà	UM																											
RC1372A0	RACCORDO DRITTO Ø10M-1/4 M.CI	2	PZ																											
VL1014A0	RIDUTTORE DI PRESSIONE CON DISTRIBUTOR	1	PZ																											
VL1014B0	RIDUTTORE DI PRESSIONE CON DISTRIBUTOR	1	PZ																											
VM1053A0	TAPPO 1/8" CIL CON O-RIN	2	PZ																											
VM1054A0	GHIERA RIDUTTORE DI PRESSIONE H7.8	1	PZ																											



COMPONENTE			RICAMBIO																																																																														
Codice	Descrizione	Immagine	Codice	Descrizione	Lista componenti																																																																												
VL1071A	RIDUTTORE DI PRESSIONE CON DISTRIBUTORE		KVL0007A	KIT IMPIANTO LAVAGGIO S. 5E BIG	<table border="1"> <thead> <tr> <th>Codice</th> <th>Descrizione</th> <th>Qtà</th> <th>UM</th> </tr> </thead> <tbody> <tr> <td>0H6441A2</td> <td>SUPPORTO IMPIANTO IDRICO DOPPIO VERT</td> <td>1</td> <td>PZ</td> </tr> <tr> <td>EL1020A0</td> <td>RACCORDO INTERMEDIO "T" TUBO Ø8</td> <td>6</td> <td>PZ</td> </tr> <tr> <td>EL1020A1</td> <td>RACCORDO INTERMEDIO "T" TUBO D8 J</td> <td>6</td> <td>PZ</td> </tr> <tr> <td>EL1115A0</td> <td>RACCORDO A Y Ø8 FEMMINA</td> <td>3</td> <td>PZ</td> </tr> <tr> <td>EL1180A0</td> <td>RACCORDO NON RITORNO Ø8 Ø8 FEMMIN</td> <td>3</td> <td>PZ</td> </tr> <tr> <td>EL1185A0</td> <td>RACCORDO A GOMITO J.GUEST Ø8F - Ø8F</td> <td>4</td> <td>PZ</td> </tr> <tr> <td>EL1185B0</td> <td>RACCORDO GOMITO Ø8F-Ø8F</td> <td>4</td> <td>PZ</td> </tr> <tr> <td>EL1195A0</td> <td>RACCORDO A GOMITO Ø8F-Ø8M</td> <td>8</td> <td>PZ</td> </tr> <tr> <td>EL1195B0</td> <td>RACCORDO GOMITO Ø8F-Ø8M</td> <td>8</td> <td>PZ</td> </tr> <tr> <td>EL1345A0</td> <td>CLIP BLOCCA PINZETTA RACCORDI Ø8</td> <td>4</td> <td>PZ</td> </tr> <tr> <td>EL1411A0</td> <td>ELETTROVALVOLA H2O CON CHECK VALVE</td> <td>2</td> <td>PZ</td> </tr> <tr> <td>RC1003A0</td> <td>RACCORDO 8M-1/8 BSPP</td> <td>2</td> <td>PZ</td> </tr> <tr> <td>RC1019A0</td> <td>FASCETTA ELASTICA D10 ZINCATA</td> <td>6</td> <td>PZ</td> </tr> <tr> <td>RC1130A0</td> <td>FASCETTA 130X2,6</td> <td>4</td> <td>PZ</td> </tr> <tr> <td>RC1372A0</td> <td>RACCORDO DRITTO Ø10M-1/4 M CI</td> <td>1</td> <td>PZ</td> </tr> <tr> <td>TB1815A0</td> <td>TUBO PE 7,93X4,75 TRASPARENT</td> <td>4.140</td> <td>M</td> </tr> <tr> <td>TB2820A0</td> <td>TUBO EPDM 6X10</td> <td>0.130</td> <td>M</td> </tr> <tr> <td>VH1220A1</td> <td>VITE AUTOFILETTA NTE 4.2X11 TCS+ MARUTE</td> <td>2</td> <td>PZ</td> </tr> </tbody> </table>	Codice	Descrizione	Qtà	UM	0H6441A2	SUPPORTO IMPIANTO IDRICO DOPPIO VERT	1	PZ	EL1020A0	RACCORDO INTERMEDIO "T" TUBO Ø8	6	PZ	EL1020A1	RACCORDO INTERMEDIO "T" TUBO D8 J	6	PZ	EL1115A0	RACCORDO A Y Ø8 FEMMINA	3	PZ	EL1180A0	RACCORDO NON RITORNO Ø8 Ø8 FEMMIN	3	PZ	EL1185A0	RACCORDO A GOMITO J.GUEST Ø8F - Ø8F	4	PZ	EL1185B0	RACCORDO GOMITO Ø8F-Ø8F	4	PZ	EL1195A0	RACCORDO A GOMITO Ø8F-Ø8M	8	PZ	EL1195B0	RACCORDO GOMITO Ø8F-Ø8M	8	PZ	EL1345A0	CLIP BLOCCA PINZETTA RACCORDI Ø8	4	PZ	EL1411A0	ELETTROVALVOLA H2O CON CHECK VALVE	2	PZ	RC1003A0	RACCORDO 8M-1/8 BSPP	2	PZ	RC1019A0	FASCETTA ELASTICA D10 ZINCATA	6	PZ	RC1130A0	FASCETTA 130X2,6	4	PZ	RC1372A0	RACCORDO DRITTO Ø10M-1/4 M CI	1	PZ	TB1815A0	TUBO PE 7,93X4,75 TRASPARENT	4.140	M	TB2820A0	TUBO EPDM 6X10	0.130	M	VH1220A1	VITE AUTOFILETTA NTE 4.2X11 TCS+ MARUTE	2	PZ
Codice	Descrizione	Qtà	UM																																																																														
0H6441A2	SUPPORTO IMPIANTO IDRICO DOPPIO VERT	1	PZ																																																																														
EL1020A0	RACCORDO INTERMEDIO "T" TUBO Ø8	6	PZ																																																																														
EL1020A1	RACCORDO INTERMEDIO "T" TUBO D8 J	6	PZ																																																																														
EL1115A0	RACCORDO A Y Ø8 FEMMINA	3	PZ																																																																														
EL1180A0	RACCORDO NON RITORNO Ø8 Ø8 FEMMIN	3	PZ																																																																														
EL1185A0	RACCORDO A GOMITO J.GUEST Ø8F - Ø8F	4	PZ																																																																														
EL1185B0	RACCORDO GOMITO Ø8F-Ø8F	4	PZ																																																																														
EL1195A0	RACCORDO A GOMITO Ø8F-Ø8M	8	PZ																																																																														
EL1195B0	RACCORDO GOMITO Ø8F-Ø8M	8	PZ																																																																														
EL1345A0	CLIP BLOCCA PINZETTA RACCORDI Ø8	4	PZ																																																																														
EL1411A0	ELETTROVALVOLA H2O CON CHECK VALVE	2	PZ																																																																														
RC1003A0	RACCORDO 8M-1/8 BSPP	2	PZ																																																																														
RC1019A0	FASCETTA ELASTICA D10 ZINCATA	6	PZ																																																																														
RC1130A0	FASCETTA 130X2,6	4	PZ																																																																														
RC1372A0	RACCORDO DRITTO Ø10M-1/4 M CI	1	PZ																																																																														
TB1815A0	TUBO PE 7,93X4,75 TRASPARENT	4.140	M																																																																														
TB2820A0	TUBO EPDM 6X10	0.130	M																																																																														
VH1220A1	VITE AUTOFILETTA NTE 4.2X11 TCS+ MARUTE	2	PZ																																																																														

COMPONENTE			RICAMBIO																																										
Codice	Descrizione	Immagine	Codice	Descrizione	Lista componenti																																								
VL1071A	RIDUTTORE DI PRESSIONE CON DISTRIBUTORE		KVL0007A	KIT IMPIANTO LAVAGGIO S. 5E BIG	<table border="1"> <thead> <tr> <th>Codice</th> <th>Descrizione</th> <th>Qtà</th> <th>UM</th> </tr> </thead> <tbody> <tr> <td>VL1014A0</td> <td>RIDUTTORE DI PRESSIONE CON DISTRIBUTOR</td> <td>1</td> <td>PZ</td> </tr> <tr> <td>VL1038A2</td> <td>POMPA VIBRAZIONE</td> <td>2</td> <td>PZ</td> </tr> <tr> <td>VL1046A1</td> <td>PORTAGOMM A D6-CODOLO D6</td> <td>1</td> <td>PZ</td> </tr> <tr> <td>VL1047A1</td> <td>PORTAGOMM A D6 CODOLO D8</td> <td>5</td> <td>PZ</td> </tr> <tr> <td>VL1071A0</td> <td>RIDUTTORE DI PRESSIONE CON DISTRIBUTOR</td> <td>1</td> <td>PZ</td> </tr> <tr> <td>VM1630A0</td> <td>TAPPO PREMI VETRO INTERNO</td> <td>2</td> <td>PZ</td> </tr> <tr> <td>VM1794A0</td> <td>FASCETTA 250X4.8 PA66 NERA</td> <td>4</td> <td>PZ</td> </tr> <tr> <td>VM2028A0</td> <td>RONDELLA GOMMA 20X10X4</td> <td>1</td> <td>PZ</td> </tr> <tr> <td>VM2059A0</td> <td>TAPPO 1/4" CIL CON O-RING*</td> <td>1</td> <td>PZ</td> </tr> </tbody> </table>	Codice	Descrizione	Qtà	UM	VL1014A0	RIDUTTORE DI PRESSIONE CON DISTRIBUTOR	1	PZ	VL1038A2	POMPA VIBRAZIONE	2	PZ	VL1046A1	PORTAGOMM A D6-CODOLO D6	1	PZ	VL1047A1	PORTAGOMM A D6 CODOLO D8	5	PZ	VL1071A0	RIDUTTORE DI PRESSIONE CON DISTRIBUTOR	1	PZ	VM1630A0	TAPPO PREMI VETRO INTERNO	2	PZ	VM1794A0	FASCETTA 250X4.8 PA66 NERA	4	PZ	VM2028A0	RONDELLA GOMMA 20X10X4	1	PZ	VM2059A0	TAPPO 1/4" CIL CON O-RING*	1	PZ
			Codice	Descrizione	Qtà	UM																																							
VL1014A0	RIDUTTORE DI PRESSIONE CON DISTRIBUTOR	1	PZ																																										
VL1038A2	POMPA VIBRAZIONE	2	PZ																																										
VL1046A1	PORTAGOMM A D6-CODOLO D6	1	PZ																																										
VL1047A1	PORTAGOMM A D6 CODOLO D8	5	PZ																																										
VL1071A0	RIDUTTORE DI PRESSIONE CON DISTRIBUTOR	1	PZ																																										
VM1630A0	TAPPO PREMI VETRO INTERNO	2	PZ																																										
VM1794A0	FASCETTA 250X4.8 PA66 NERA	4	PZ																																										
VM2028A0	RONDELLA GOMMA 20X10X4	1	PZ																																										
VM2059A0	TAPPO 1/4" CIL CON O-RING*	1	PZ																																										
KVL0005A	KIT IMPIANTO LAVAGGIO SERIE 5E	<table border="1"> <thead> <tr> <th>Codice</th> <th>Descrizione</th> <th>Qtà</th> <th>UM</th> </tr> </thead> <tbody> <tr> <td>0H6413A3</td> <td>SUPPORTO IMPIANTO IDRICO</td> <td>1</td> <td>PZ</td> </tr> <tr> <td>EL1020A0</td> <td>RACCORDO INTERMEDIO "T" TUBO Ø8</td> <td>1</td> <td>PZ</td> </tr> <tr> <td>EL1020A1</td> <td>RACCORDO INTERMEDIO "T" TUBO D8 J</td> <td>1</td> <td>PZ</td> </tr> <tr> <td>EL1115A0</td> <td>RACCORDO A Y Ø8 FEMMINA</td> <td>2</td> <td>PZ</td> </tr> <tr> <td>EL1180A0</td> <td>RACCORDO NON RITORNO Ø8 Ø8 FEMMINA</td> <td>1</td> <td>PZ</td> </tr> <tr> <td>EL1185A0</td> <td>RACCORDO A GOMITO J.GUEST Ø8F - Ø8F</td> <td>1</td> <td>PZ</td> </tr> <tr> <td>EL1195A0</td> <td>RACCORDO A GOMITO Ø8F-Ø8M</td> <td>2</td> <td>PZ</td> </tr> <tr> <td>EL1195B0</td> <td>RACCORDO GOMITO Ø8F-Ø8M</td> <td>2</td> <td>PZ</td> </tr> </tbody> </table>	Codice	Descrizione	Qtà	UM	0H6413A3	SUPPORTO IMPIANTO IDRICO	1	PZ	EL1020A0	RACCORDO INTERMEDIO "T" TUBO Ø8	1	PZ	EL1020A1	RACCORDO INTERMEDIO "T" TUBO D8 J	1	PZ	EL1115A0	RACCORDO A Y Ø8 FEMMINA	2	PZ	EL1180A0	RACCORDO NON RITORNO Ø8 Ø8 FEMMINA	1	PZ	EL1185A0	RACCORDO A GOMITO J.GUEST Ø8F - Ø8F	1	PZ	EL1195A0	RACCORDO A GOMITO Ø8F-Ø8M	2	PZ	EL1195B0	RACCORDO GOMITO Ø8F-Ø8M	2	PZ							
Codice	Descrizione	Qtà	UM																																										
0H6413A3	SUPPORTO IMPIANTO IDRICO	1	PZ																																										
EL1020A0	RACCORDO INTERMEDIO "T" TUBO Ø8	1	PZ																																										
EL1020A1	RACCORDO INTERMEDIO "T" TUBO D8 J	1	PZ																																										
EL1115A0	RACCORDO A Y Ø8 FEMMINA	2	PZ																																										
EL1180A0	RACCORDO NON RITORNO Ø8 Ø8 FEMMINA	1	PZ																																										
EL1185A0	RACCORDO A GOMITO J.GUEST Ø8F - Ø8F	1	PZ																																										
EL1195A0	RACCORDO A GOMITO Ø8F-Ø8M	2	PZ																																										
EL1195B0	RACCORDO GOMITO Ø8F-Ø8M	2	PZ																																										

COMPONENTE			RICAMBIO																																																																																		
Codice	Descrizione	Immagine	Codice	Descrizione	Lista componenti																																																																																
VL1071A	RIDUTTORE DI PRESSIONE CON DISTRIBUTORE		KVL0005A	KIT IMPIANTO LAVAGGIO SERIE 5E	<table border="1"> <thead> <tr> <th>Codice</th> <th>Descrizione</th> <th>Qtà</th> <th>UM</th> </tr> </thead> <tbody> <tr> <td>EL1345A0</td> <td>CLIP BLOCCA PINZETTA RACCORDI Ø8</td> <td>2</td> <td>PZ</td> </tr> <tr> <td>EL1411A0</td> <td>ELETTROVALVOLA H2O CON CHECK VALVE</td> <td>1</td> <td>PZ</td> </tr> <tr> <td>RC1003A0</td> <td>RACCORDO Ø8M-1/8 BSPP</td> <td>2</td> <td>PZ</td> </tr> <tr> <td>RC1019A0</td> <td>FASCETTA ELASTICA D10 ZINCATA</td> <td>4</td> <td>PZ</td> </tr> <tr> <td>RC1130A0</td> <td>FASCETTA 130X2,6</td> <td>2</td> <td>PZ</td> </tr> <tr> <td>RC1369A0</td> <td>RACCORDO DRITTO Ø8F-1/8" M CIL</td> <td>2</td> <td>PZ</td> </tr> <tr> <td>RC1372A0</td> <td>RACCORDO DRITTO Ø10M-1/4 M CI</td> <td>1</td> <td>PZ</td> </tr> <tr> <td>TB1815A0</td> <td>TUBO PE 7,93X4,75 TRASPARENT</td> <td>1.500</td> <td>M</td> </tr> <tr> <td>TB1816A0</td> <td>TUBO PP 6X4 TRASPARENT</td> <td>0.250</td> <td>M</td> </tr> <tr> <td>TB2820A0</td> <td>TUBO EPDM 6X10</td> <td>0.270</td> <td>M</td> </tr> <tr> <td>VI1220A1</td> <td>VITE AUTOFILETTA NTE 4.2X11 TCS+ MARUTE</td> <td>1</td> <td>PZ</td> </tr> <tr> <td>VL1014A0</td> <td>RIDUTTORE DI PRESSIONE CON DISTRIBUTOR</td> <td>1</td> <td>PZ</td> </tr> <tr> <td>VL1038A2</td> <td>POMPA VIBRAZIONE</td> <td>1</td> <td>PZ</td> </tr> <tr> <td>VL1046A1</td> <td>PORTAGOMMA A D6-CODOLO D6</td> <td>1</td> <td>PZ</td> </tr> <tr> <td>VL1047A1</td> <td>PORTAGOMMA A D6 CODOLO D8</td> <td>2</td> <td>PZ</td> </tr> <tr> <td>VL1071A0</td> <td>RIDUTTORE DI PRESSIONE CON DISTRIBUTOR</td> <td>1</td> <td>PZ</td> </tr> <tr> <td>VM1630A0</td> <td>TAPPO PREMI VETRO INTERNO</td> <td>2</td> <td>PZ</td> </tr> <tr> <td>VM1794A0</td> <td>FASCETTA 250X4.8 PA66 NERA</td> <td>1</td> <td>PZ</td> </tr> <tr> <td>VM2028A0</td> <td>RONDELLA GOMMA 20X10X4</td> <td>1</td> <td>PZ</td> </tr> </tbody> </table>	Codice	Descrizione	Qtà	UM	EL1345A0	CLIP BLOCCA PINZETTA RACCORDI Ø8	2	PZ	EL1411A0	ELETTROVALVOLA H2O CON CHECK VALVE	1	PZ	RC1003A0	RACCORDO Ø8M-1/8 BSPP	2	PZ	RC1019A0	FASCETTA ELASTICA D10 ZINCATA	4	PZ	RC1130A0	FASCETTA 130X2,6	2	PZ	RC1369A0	RACCORDO DRITTO Ø8F-1/8" M CIL	2	PZ	RC1372A0	RACCORDO DRITTO Ø10M-1/4 M CI	1	PZ	TB1815A0	TUBO PE 7,93X4,75 TRASPARENT	1.500	M	TB1816A0	TUBO PP 6X4 TRASPARENT	0.250	M	TB2820A0	TUBO EPDM 6X10	0.270	M	VI1220A1	VITE AUTOFILETTA NTE 4.2X11 TCS+ MARUTE	1	PZ	VL1014A0	RIDUTTORE DI PRESSIONE CON DISTRIBUTOR	1	PZ	VL1038A2	POMPA VIBRAZIONE	1	PZ	VL1046A1	PORTAGOMMA A D6-CODOLO D6	1	PZ	VL1047A1	PORTAGOMMA A D6 CODOLO D8	2	PZ	VL1071A0	RIDUTTORE DI PRESSIONE CON DISTRIBUTOR	1	PZ	VM1630A0	TAPPO PREMI VETRO INTERNO	2	PZ	VM1794A0	FASCETTA 250X4.8 PA66 NERA	1	PZ	VM2028A0	RONDELLA GOMMA 20X10X4	1	PZ
Codice	Descrizione	Qtà	UM																																																																																		
EL1345A0	CLIP BLOCCA PINZETTA RACCORDI Ø8	2	PZ																																																																																		
EL1411A0	ELETTROVALVOLA H2O CON CHECK VALVE	1	PZ																																																																																		
RC1003A0	RACCORDO Ø8M-1/8 BSPP	2	PZ																																																																																		
RC1019A0	FASCETTA ELASTICA D10 ZINCATA	4	PZ																																																																																		
RC1130A0	FASCETTA 130X2,6	2	PZ																																																																																		
RC1369A0	RACCORDO DRITTO Ø8F-1/8" M CIL	2	PZ																																																																																		
RC1372A0	RACCORDO DRITTO Ø10M-1/4 M CI	1	PZ																																																																																		
TB1815A0	TUBO PE 7,93X4,75 TRASPARENT	1.500	M																																																																																		
TB1816A0	TUBO PP 6X4 TRASPARENT	0.250	M																																																																																		
TB2820A0	TUBO EPDM 6X10	0.270	M																																																																																		
VI1220A1	VITE AUTOFILETTA NTE 4.2X11 TCS+ MARUTE	1	PZ																																																																																		
VL1014A0	RIDUTTORE DI PRESSIONE CON DISTRIBUTOR	1	PZ																																																																																		
VL1038A2	POMPA VIBRAZIONE	1	PZ																																																																																		
VL1046A1	PORTAGOMMA A D6-CODOLO D6	1	PZ																																																																																		
VL1047A1	PORTAGOMMA A D6 CODOLO D8	2	PZ																																																																																		
VL1071A0	RIDUTTORE DI PRESSIONE CON DISTRIBUTOR	1	PZ																																																																																		
VM1630A0	TAPPO PREMI VETRO INTERNO	2	PZ																																																																																		
VM1794A0	FASCETTA 250X4.8 PA66 NERA	1	PZ																																																																																		
VM2028A0	RONDELLA GOMMA 20X10X4	1	PZ																																																																																		

COMPONENTE			RICAMBIO																																																						
Codice	Descrizione	Immagine	Codice	Descrizione	Lista componenti																																																				
VL1071A	RIDUTTORE DI PRESSIONE CON DISTRIBUTORE		KVL0005A	KIT IMPIANTO LAVAGGIO SERIE 5E	<table border="1"> <thead> <tr> <th>Codice</th> <th>Descrizione</th> <th>Qtà</th> <th>UM</th> </tr> </thead> <tbody> <tr> <td>VM2029A0</td> <td>RONDELLA GOMMA 20X8X4</td> <td>1</td> <td>PZ</td> </tr> <tr> <td>VM2059A0</td> <td>TAPPO 1/4" CIL CON O-RING*</td> <td>1</td> <td>PZ</td> </tr> <tr> <td>VM2147A0</td> <td>SPUGNA ESD ROSA LISCIA 410X343X15 M</td> <td>1</td> <td>PZ</td> </tr> </tbody> </table>	Codice	Descrizione	Qtà	UM	VM2029A0	RONDELLA GOMMA 20X8X4	1	PZ	VM2059A0	TAPPO 1/4" CIL CON O-RING*	1	PZ	VM2147A0	SPUGNA ESD ROSA LISCIA 410X343X15 M	1	PZ																																				
Codice	Descrizione	Qtà	UM																																																						
VM2029A0	RONDELLA GOMMA 20X8X4	1	PZ																																																						
VM2059A0	TAPPO 1/4" CIL CON O-RING*	1	PZ																																																						
VM2147A0	SPUGNA ESD ROSA LISCIA 410X343X15 M	1	PZ																																																						
RC1372A	RACCORDO DRITTO Ø10M-1/4 M CIL		KVL1117A	KIT FILTRO+RID. PRESS. EUR MM 2016+LMTOP	<table border="1"> <thead> <tr> <th>Codice</th> <th>Descrizione</th> <th>Qtà</th> <th>UM</th> </tr> </thead> <tbody> <tr> <td>0H7472A1</td> <td>LAMIERA SUPPORTO DISTRIBUTOR</td> <td>1</td> <td>PZ</td> </tr> <tr> <td>RC1004A0</td> <td>RACCORDO Y Ø10-Ø8-8</td> <td>1</td> <td>PZ</td> </tr> <tr> <td>RC1243A0</td> <td>RACCORDO GOMITO Ø10F-Ø10M</td> <td>1</td> <td>PZ</td> </tr> <tr> <td>RC1372A0</td> <td>RACCORDO DRITTO Ø10M-1/4 M CI</td> <td>2</td> <td>PZ</td> </tr> <tr> <td>VI1013A1</td> <td>RONDELLA PIANA 30.5X39.5X3 NYLON</td> <td>1</td> <td>PZ</td> </tr> <tr> <td>VI1220A1</td> <td>VITE AUTOFILETTA NTE 4.2X11 TCS+ MARUTE</td> <td>2</td> <td>PZ</td> </tr> <tr> <td>VL1014A0</td> <td>RIDUTTORE DI PRESSIONE CON DISTRIBUTOR</td> <td>1</td> <td>PZ</td> </tr> <tr> <td>VL1014B0</td> <td>RIDUTTORE DI PRESSIONE CON DISTRIBUTOR</td> <td>1</td> <td>PZ</td> </tr> <tr> <td>VL1034C0</td> <td>FILTRO ACQUA D10 MESH100</td> <td>1</td> <td>PZ</td> </tr> <tr> <td>VL1062C0</td> <td>FORCELLA BLOCCA FILTRO-RIDUTTORE PRES.</td> <td>1</td> <td>PZ</td> </tr> <tr> <td>VM1053A0</td> <td>TAPPO 1/8" CIL CON O-RIN</td> <td>2</td> <td>PZ</td> </tr> <tr> <td>VM1054A0</td> <td>GHIERA RIDUTTORE DI PRESSIONE H7.8</td> <td>1</td> <td>PZ</td> </tr> </tbody> </table>	Codice	Descrizione	Qtà	UM	0H7472A1	LAMIERA SUPPORTO DISTRIBUTOR	1	PZ	RC1004A0	RACCORDO Y Ø10-Ø8-8	1	PZ	RC1243A0	RACCORDO GOMITO Ø10F-Ø10M	1	PZ	RC1372A0	RACCORDO DRITTO Ø10M-1/4 M CI	2	PZ	VI1013A1	RONDELLA PIANA 30.5X39.5X3 NYLON	1	PZ	VI1220A1	VITE AUTOFILETTA NTE 4.2X11 TCS+ MARUTE	2	PZ	VL1014A0	RIDUTTORE DI PRESSIONE CON DISTRIBUTOR	1	PZ	VL1014B0	RIDUTTORE DI PRESSIONE CON DISTRIBUTOR	1	PZ	VL1034C0	FILTRO ACQUA D10 MESH100	1	PZ	VL1062C0	FORCELLA BLOCCA FILTRO-RIDUTTORE PRES.	1	PZ	VM1053A0	TAPPO 1/8" CIL CON O-RIN	2	PZ	VM1054A0	GHIERA RIDUTTORE DI PRESSIONE H7.8	1	PZ
Codice	Descrizione	Qtà	UM																																																						
0H7472A1	LAMIERA SUPPORTO DISTRIBUTOR	1	PZ																																																						
RC1004A0	RACCORDO Y Ø10-Ø8-8	1	PZ																																																						
RC1243A0	RACCORDO GOMITO Ø10F-Ø10M	1	PZ																																																						
RC1372A0	RACCORDO DRITTO Ø10M-1/4 M CI	2	PZ																																																						
VI1013A1	RONDELLA PIANA 30.5X39.5X3 NYLON	1	PZ																																																						
VI1220A1	VITE AUTOFILETTA NTE 4.2X11 TCS+ MARUTE	2	PZ																																																						
VL1014A0	RIDUTTORE DI PRESSIONE CON DISTRIBUTOR	1	PZ																																																						
VL1014B0	RIDUTTORE DI PRESSIONE CON DISTRIBUTOR	1	PZ																																																						
VL1034C0	FILTRO ACQUA D10 MESH100	1	PZ																																																						
VL1062C0	FORCELLA BLOCCA FILTRO-RIDUTTORE PRES.	1	PZ																																																						
VM1053A0	TAPPO 1/8" CIL CON O-RIN	2	PZ																																																						
VM1054A0	GHIERA RIDUTTORE DI PRESSIONE H7.8	1	PZ																																																						

COMPONENTE			RICAMBIO																																																						
Codice	Descrizione	Immagine	Codice	Descrizione	Lista componenti																																																				
RC1372A	RACCORDO DRITTO Ø10M-1/4 M CIL		KRC1372A	KIT RACCORDO DRITTO D 10M-1/4 M CIL	<table border="1"> <thead> <tr> <th>Codice</th> <th>Descrizione</th> <th>Qtà</th> <th>UM</th> </tr> </thead> <tbody> <tr> <td>RC1372A0</td> <td>RACCORDO DRITTO Ø10M-1/4 M CI</td> <td>1</td> <td>PZ</td> </tr> </tbody> </table>	Codice	Descrizione	Qtà	UM	RC1372A0	RACCORDO DRITTO Ø10M-1/4 M CI	1	PZ																																												
Codice	Descrizione	Qtà	UM																																																						
RC1372A0	RACCORDO DRITTO Ø10M-1/4 M CI	1	PZ																																																						
VL1014B	RIDUTTORE DI PRESSIONE CON DISTRIBUTORE		KVL1117A	KIT FILTRO+RID. PRESS. EUR MM 2016+LMTOP	<table border="1"> <thead> <tr> <th>Codice</th> <th>Descrizione</th> <th>Qtà</th> <th>UM</th> </tr> </thead> <tbody> <tr> <td>0H7472A1</td> <td>LAMIERA SUPPORTO DISTRIBUTOR</td> <td>1</td> <td>PZ</td> </tr> <tr> <td>RC1004A0</td> <td>RACCORDO Y Ø10-Ø8-8</td> <td>1</td> <td>PZ</td> </tr> <tr> <td>RC1243A0</td> <td>RACCORDO GOMITO CODOLO Ø10F-Ø10M</td> <td>1</td> <td>PZ</td> </tr> <tr> <td>RC1372A0</td> <td>RACCORDO DRITTO Ø10M-1/4 M CI</td> <td>2</td> <td>PZ</td> </tr> <tr> <td>VI1013A1</td> <td>RONDELLA PIANA 30.5X39.5X3 NYLON</td> <td>1</td> <td>PZ</td> </tr> <tr> <td>VI1220A1</td> <td>VITE AUTOFILETTA NTE 4.2X11 TCS+ MARUTE</td> <td>2</td> <td>PZ</td> </tr> <tr> <td>VL1014A0</td> <td>RIDUTTORE DI PRESSIONE CON DISTRIBUTOR</td> <td>1</td> <td>PZ</td> </tr> <tr> <td>VL1014B0</td> <td>RIDUTTORE DI PRESSIONE CON DISTRIBUTOR</td> <td>1</td> <td>PZ</td> </tr> <tr> <td>VL1034C0</td> <td>FILTRO ACQUA D10 MESH100</td> <td>1</td> <td>PZ</td> </tr> <tr> <td>VL1062C0</td> <td>FORCELLA BLOCCA FILTRO-RIDUT TORE PRES.</td> <td>1</td> <td>PZ</td> </tr> <tr> <td>VM1053A0</td> <td>TAPPO 1/8" CIL CON O-RIN</td> <td>2</td> <td>PZ</td> </tr> <tr> <td>VM1054A0</td> <td>GHIERA RIDUTTORE DI PRESSIONE H7.8</td> <td>1</td> <td>PZ</td> </tr> </tbody> </table>	Codice	Descrizione	Qtà	UM	0H7472A1	LAMIERA SUPPORTO DISTRIBUTOR	1	PZ	RC1004A0	RACCORDO Y Ø10-Ø8-8	1	PZ	RC1243A0	RACCORDO GOMITO CODOLO Ø10F-Ø10M	1	PZ	RC1372A0	RACCORDO DRITTO Ø10M-1/4 M CI	2	PZ	VI1013A1	RONDELLA PIANA 30.5X39.5X3 NYLON	1	PZ	VI1220A1	VITE AUTOFILETTA NTE 4.2X11 TCS+ MARUTE	2	PZ	VL1014A0	RIDUTTORE DI PRESSIONE CON DISTRIBUTOR	1	PZ	VL1014B0	RIDUTTORE DI PRESSIONE CON DISTRIBUTOR	1	PZ	VL1034C0	FILTRO ACQUA D10 MESH100	1	PZ	VL1062C0	FORCELLA BLOCCA FILTRO-RIDUT TORE PRES.	1	PZ	VM1053A0	TAPPO 1/8" CIL CON O-RIN	2	PZ	VM1054A0	GHIERA RIDUTTORE DI PRESSIONE H7.8	1	PZ
Codice	Descrizione	Qtà	UM																																																						
0H7472A1	LAMIERA SUPPORTO DISTRIBUTOR	1	PZ																																																						
RC1004A0	RACCORDO Y Ø10-Ø8-8	1	PZ																																																						
RC1243A0	RACCORDO GOMITO CODOLO Ø10F-Ø10M	1	PZ																																																						
RC1372A0	RACCORDO DRITTO Ø10M-1/4 M CI	2	PZ																																																						
VI1013A1	RONDELLA PIANA 30.5X39.5X3 NYLON	1	PZ																																																						
VI1220A1	VITE AUTOFILETTA NTE 4.2X11 TCS+ MARUTE	2	PZ																																																						
VL1014A0	RIDUTTORE DI PRESSIONE CON DISTRIBUTOR	1	PZ																																																						
VL1014B0	RIDUTTORE DI PRESSIONE CON DISTRIBUTOR	1	PZ																																																						
VL1034C0	FILTRO ACQUA D10 MESH100	1	PZ																																																						
VL1062C0	FORCELLA BLOCCA FILTRO-RIDUT TORE PRES.	1	PZ																																																						
VM1053A0	TAPPO 1/8" CIL CON O-RIN	2	PZ																																																						
VM1054A0	GHIERA RIDUTTORE DI PRESSIONE H7.8	1	PZ																																																						

COMPONENTE			RICAMBIO																																										
Codice	Descrizione	Immagine	Codice	Descrizione	Lista componenti																																								
VL1014B	RIDUTTORE DI PRESSIONE CON DISTRIBUTORE		KVL1014B	KIT RIDUTTORE DI PRESSIONE EURO MM	<table border="1"> <thead> <tr> <th>Codice</th> <th>Descrizione</th> <th>Qtà</th> <th>UM</th> </tr> </thead> <tbody> <tr> <td>EL1185A0</td> <td>RACCORDO A GOMITO J.GUEST Ø8F - Ø8F</td> <td>1</td> <td>PZ</td> </tr> <tr> <td>RC1003A0</td> <td>RACCORDO 8M-1/8 BSPP</td> <td>2</td> <td>PZ</td> </tr> <tr> <td>RC1372A0</td> <td>RACCORDO DRITTO Ø10M-1/4 M.CI</td> <td>1</td> <td>PZ</td> </tr> <tr> <td>RC1396A0</td> <td>TERMINALE DRITTO JG D10-1/4</td> <td>1</td> <td>PZ</td> </tr> <tr> <td>VL1014B0</td> <td>RIDUTTORE DI PRESSIONE CON DISTRIBUTOR</td> <td>1</td> <td>PZ</td> </tr> <tr> <td>VL1071A0</td> <td>RIDUTTORE DI PRESSIONE CON DISTRIBUTOR</td> <td>1</td> <td>PZ</td> </tr> <tr> <td>VM1054A0</td> <td>GHIERA RIDUTTORE DI PRESSIONE H7.8</td> <td>1</td> <td>PZ</td> </tr> <tr> <td>VM2028A0</td> <td>RONDELLA GOMMA 20X10X4</td> <td>1</td> <td>PZ</td> </tr> <tr> <td>VM2059A0</td> <td>TAPPO 1/4" CIL CON O-RING*</td> <td>1</td> <td>PZ</td> </tr> </tbody> </table>	Codice	Descrizione	Qtà	UM	EL1185A0	RACCORDO A GOMITO J.GUEST Ø8F - Ø8F	1	PZ	RC1003A0	RACCORDO 8M-1/8 BSPP	2	PZ	RC1372A0	RACCORDO DRITTO Ø10M-1/4 M.CI	1	PZ	RC1396A0	TERMINALE DRITTO JG D10-1/4	1	PZ	VL1014B0	RIDUTTORE DI PRESSIONE CON DISTRIBUTOR	1	PZ	VL1071A0	RIDUTTORE DI PRESSIONE CON DISTRIBUTOR	1	PZ	VM1054A0	GHIERA RIDUTTORE DI PRESSIONE H7.8	1	PZ	VM2028A0	RONDELLA GOMMA 20X10X4	1	PZ	VM2059A0	TAPPO 1/4" CIL CON O-RING*	1	PZ
			Codice	Descrizione	Qtà	UM																																							
			EL1185A0	RACCORDO A GOMITO J.GUEST Ø8F - Ø8F	1	PZ																																							
RC1003A0	RACCORDO 8M-1/8 BSPP	2	PZ																																										
RC1372A0	RACCORDO DRITTO Ø10M-1/4 M.CI	1	PZ																																										
RC1396A0	TERMINALE DRITTO JG D10-1/4	1	PZ																																										
VL1014B0	RIDUTTORE DI PRESSIONE CON DISTRIBUTOR	1	PZ																																										
VL1071A0	RIDUTTORE DI PRESSIONE CON DISTRIBUTOR	1	PZ																																										
VM1054A0	GHIERA RIDUTTORE DI PRESSIONE H7.8	1	PZ																																										
VM2028A0	RONDELLA GOMMA 20X10X4	1	PZ																																										
VM2059A0	TAPPO 1/4" CIL CON O-RING*	1	PZ																																										
KVL0014B	KIT RIDUTTORE PRESSIONE MM EUR V2 2017	<table border="1"> <thead> <tr> <th>Codice</th> <th>Descrizione</th> <th>Qtà</th> <th>UM</th> </tr> </thead> <tbody> <tr> <td>RC1372A0</td> <td>RACCORDO DRITTO Ø10M-1/4 M.CI</td> <td>1</td> <td>PZ</td> </tr> <tr> <td>RC1396A0</td> <td>TERMINALE DRITTO JG D10-1/4</td> <td>1</td> <td>PZ</td> </tr> <tr> <td>VL1014B0</td> <td>RIDUTTORE DI PRESSIONE CON DISTRIBUTOR</td> <td>1</td> <td>PZ</td> </tr> <tr> <td>VM1054A0</td> <td>GHIERA RIDUTTORE DI PRESSIONE H7.8</td> <td>1</td> <td>PZ</td> </tr> </tbody> </table>	Codice	Descrizione	Qtà	UM	RC1372A0	RACCORDO DRITTO Ø10M-1/4 M.CI	1	PZ	RC1396A0	TERMINALE DRITTO JG D10-1/4	1	PZ	VL1014B0	RIDUTTORE DI PRESSIONE CON DISTRIBUTOR	1	PZ	VM1054A0	GHIERA RIDUTTORE DI PRESSIONE H7.8	1	PZ																							
Codice	Descrizione	Qtà	UM																																										
RC1372A0	RACCORDO DRITTO Ø10M-1/4 M.CI	1	PZ																																										
RC1396A0	TERMINALE DRITTO JG D10-1/4	1	PZ																																										
VL1014B0	RIDUTTORE DI PRESSIONE CON DISTRIBUTOR	1	PZ																																										
VM1054A0	GHIERA RIDUTTORE DI PRESSIONE H7.8	1	PZ																																										
KVL0014A	KIT RIDUTTORE DI PRESSIONE MIND.MAPS EUR	<table border="1"> <thead> <tr> <th>Codice</th> <th>Descrizione</th> <th>Qtà</th> <th>UM</th> </tr> </thead> <tbody> <tr> <td>RC1372A0</td> <td>RACCORDO DRITTO Ø10M-1/4 M.CI</td> <td>2</td> <td>PZ</td> </tr> <tr> <td>VL1014A0</td> <td>RIDUTTORE DI PRESSIONE CON DISTRIBUTOR</td> <td>1</td> <td>PZ</td> </tr> </tbody> </table>	Codice	Descrizione	Qtà	UM	RC1372A0	RACCORDO DRITTO Ø10M-1/4 M.CI	2	PZ	VL1014A0	RIDUTTORE DI PRESSIONE CON DISTRIBUTOR	1	PZ																															
Codice	Descrizione	Qtà	UM																																										
RC1372A0	RACCORDO DRITTO Ø10M-1/4 M.CI	2	PZ																																										
VL1014A0	RIDUTTORE DI PRESSIONE CON DISTRIBUTOR	1	PZ																																										



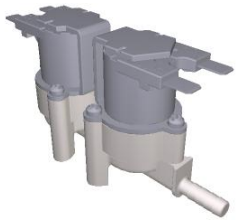
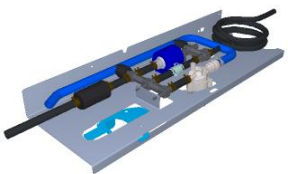

COMPONENTE			RICAMBIO																						
Codice	Descrizione	Immagine	Codice	Descrizione	Lista componenti																				
VL1014B	RIDUTTORE DI PRESSIONE CON DISTRIBUTORE		KVL0014A	KIT RIDUTTORE DI PRESSIONE MIND.MAPS EUR	<table border="1"> <thead> <tr> <th>Codice</th> <th>Descrizione</th> <th>Qtà</th> <th>UM</th> </tr> </thead> <tbody> <tr> <td>VL1014B0</td> <td>RIDUTTORE DI PRESSIONE CON DISTRIBUTOR</td> <td>1</td> <td>PZ</td> </tr> <tr> <td>VM1053A0</td> <td>TAPPO 1/8" CIL CON O-RIN</td> <td>2</td> <td>PZ</td> </tr> <tr> <td>VM1054A0</td> <td>GHIERA RIDUTTORE DI PRESSIONE H7.8</td> <td>1</td> <td>PZ</td> </tr> </tbody> </table>	Codice	Descrizione	Qtà	UM	VL1014B0	RIDUTTORE DI PRESSIONE CON DISTRIBUTOR	1	PZ	VM1053A0	TAPPO 1/8" CIL CON O-RIN	2	PZ	VM1054A0	GHIERA RIDUTTORE DI PRESSIONE H7.8	1	PZ				
			Codice		Descrizione	Qtà	UM																		
VL1014B0	RIDUTTORE DI PRESSIONE CON DISTRIBUTOR	1	PZ																						
VM1053A0	TAPPO 1/8" CIL CON O-RIN	2	PZ																						
VM1054A0	GHIERA RIDUTTORE DI PRESSIONE H7.8	1	PZ																						
KVL0010A	KIT RIDUTTORE DI PRESSIONE SERIE 4 E 5	<table border="1"> <thead> <tr> <th>Codice</th> <th>Descrizione</th> <th>Qtà</th> <th>UM</th> </tr> </thead> <tbody> <tr> <td>EL1210A0</td> <td>RACCORDO J.GUEST TERMINALE DIRITTO</td> <td>2</td> <td>PZ</td> </tr> <tr> <td>VL1014A0</td> <td>RIDUTTORE DI PRESSIONE CON DISTRIBUTOR</td> <td>1</td> <td>PZ</td> </tr> <tr> <td>VL1014B0</td> <td>RIDUTTORE DI PRESSIONE CON DISTRIBUTOR</td> <td>1</td> <td>PZ</td> </tr> <tr> <td>VM1053A0</td> <td>TAPPO 1/8" CIL CON O-RIN</td> <td>2</td> <td>PZ</td> </tr> </tbody> </table>	Codice	Descrizione	Qtà	UM	EL1210A0	RACCORDO J.GUEST TERMINALE DIRITTO	2	PZ	VL1014A0	RIDUTTORE DI PRESSIONE CON DISTRIBUTOR	1	PZ	VL1014B0	RIDUTTORE DI PRESSIONE CON DISTRIBUTOR	1	PZ	VM1053A0	TAPPO 1/8" CIL CON O-RIN	2	PZ			
Codice	Descrizione	Qtà	UM																						
EL1210A0	RACCORDO J.GUEST TERMINALE DIRITTO	2	PZ																						
VL1014A0	RIDUTTORE DI PRESSIONE CON DISTRIBUTOR	1	PZ																						
VL1014B0	RIDUTTORE DI PRESSIONE CON DISTRIBUTOR	1	PZ																						
VM1053A0	TAPPO 1/8" CIL CON O-RIN	2	PZ																						
RC1396A	TERMINALE DRITTO JG D10-1/4		KVL0014B	KIT RIDUTTORE PRESSIONE MM EUR V2 2017	<table border="1"> <thead> <tr> <th>Codice</th> <th>Descrizione</th> <th>Qtà</th> <th>UM</th> </tr> </thead> <tbody> <tr> <td>RC1372A0</td> <td>RACCORDO DRITTO Ø10M-1/4 M CI</td> <td>1</td> <td>PZ</td> </tr> <tr> <td>RC1396A0</td> <td>TERMINALE DRITTO JG D10-1/4</td> <td>1</td> <td>PZ</td> </tr> <tr> <td>VL1014B0</td> <td>RIDUTTORE DI PRESSIONE CON DISTRIBUTOR</td> <td>1</td> <td>PZ</td> </tr> <tr> <td>VM1054A0</td> <td>GHIERA RIDUTTORE DI PRESSIONE H7.8</td> <td>1</td> <td>PZ</td> </tr> </tbody> </table>	Codice	Descrizione	Qtà	UM	RC1372A0	RACCORDO DRITTO Ø10M-1/4 M CI	1	PZ	RC1396A0	TERMINALE DRITTO JG D10-1/4	1	PZ	VL1014B0	RIDUTTORE DI PRESSIONE CON DISTRIBUTOR	1	PZ	VM1054A0	GHIERA RIDUTTORE DI PRESSIONE H7.8	1	PZ
Codice	Descrizione	Qtà	UM																						
RC1372A0	RACCORDO DRITTO Ø10M-1/4 M CI	1	PZ																						
RC1396A0	TERMINALE DRITTO JG D10-1/4	1	PZ																						
VL1014B0	RIDUTTORE DI PRESSIONE CON DISTRIBUTOR	1	PZ																						
VM1054A0	GHIERA RIDUTTORE DI PRESSIONE H7.8	1	PZ																						
VL1063A	PORTAGOMMA D8 CODOLO D10		KVL1125A	KIT 10PZ RAC CURVO M-M PORTAG D8-COD D1	<table border="1"> <thead> <tr> <th>Codice</th> <th>Descrizione</th> <th>Qtà</th> <th>UM</th> </tr> </thead> <tbody> <tr> <td>VL1125A0</td> <td>RACCORDO CURVO M-M PORTAGOMMA A D8- CODOLO</td> <td>10</td> <td>PZ</td> </tr> <tr> <td>VL1125A1</td> <td>RACCORDO CURVO M-M PORTAGOMMA A D8- CODOLO</td> <td>10</td> <td>PZ</td> </tr> </tbody> </table>	Codice	Descrizione	Qtà	UM	VL1125A0	RACCORDO CURVO M-M PORTAGOMMA A D8- CODOLO	10	PZ	VL1125A1	RACCORDO CURVO M-M PORTAGOMMA A D8- CODOLO	10	PZ								
Codice	Descrizione	Qtà	UM																						
VL1125A0	RACCORDO CURVO M-M PORTAGOMMA A D8- CODOLO	10	PZ																						
VL1125A1	RACCORDO CURVO M-M PORTAGOMMA A D8- CODOLO	10	PZ																						

COMPONENTE			RICAMBIO																						
Codice	Descrizione	Immagine	Codice	Descrizione	Lista componenti																				
VL1063A	PORTAGOMMA D8 CODOLO D10		KVL1063A	KIT 10PZ PORTAGOMMA D8 CODOLO D10	<table border="1"> <thead> <tr> <th>Codice</th> <th>Descrizione</th> <th>Qtà</th> <th>UM</th> </tr> </thead> <tbody> <tr> <td>VL1063A0</td> <td>PORTAGOMMA D8 CODOLO D10</td> <td>10</td> <td>PZ</td> </tr> </tbody> </table>	Codice	Descrizione	Qtà	UM	VL1063A0	PORTAGOMMA D8 CODOLO D10	10	PZ												
Codice	Descrizione	Qtà	UM																						
VL1063A0	PORTAGOMMA D8 CODOLO D10	10	PZ																						
			KTB2237A	KIT TB2243A D10 ALLACCIAMENTO	<table border="1"> <thead> <tr> <th>Codice</th> <th>Descrizione</th> <th>Qtà</th> <th>UM</th> </tr> </thead> <tbody> <tr> <td>TB2243A0</td> <td>TUBO PET Ø10</td> <td>1.500</td> <td>M</td> </tr> </tbody> </table>	Codice	Descrizione	Qtà	UM	TB2243A0	TUBO PET Ø10	1.500	M												
Codice	Descrizione	Qtà	UM																						
TB2243A0	TUBO PET Ø10	1.500	M																						
RC1046A	FASCETTA STRINGI TUBO D10-16 H9 INO		KTB2237A	RETE 1,5M KIT TB2243A D10 ALLACCIAMENTO	<table border="1"> <thead> <tr> <th>Codice</th> <th>Descrizione</th> <th>Qtà</th> <th>UM</th> </tr> </thead> <tbody> <tr> <td>TB2243A0</td> <td>TUBO PET Ø10</td> <td>1.500</td> <td>M</td> </tr> </tbody> </table>	Codice	Descrizione	Qtà	UM	TB2243A0	TUBO PET Ø10	1.500	M												
Codice	Descrizione	Qtà	UM																						
TB2243A0	TUBO PET Ø10	1.500	M																						
			KRC1046A	RETE 1,5M KIT 10PZ FASCETTA STRINGI TUBO D10-16 H9	<table border="1"> <thead> <tr> <th>Codice</th> <th>Descrizione</th> <th>Qtà</th> <th>UM</th> </tr> </thead> <tbody> <tr> <td>RC1046A0</td> <td>FASCETTA STRINGI TUBO D10-16 H9 INO</td> <td>10</td> <td>PZ</td> </tr> </tbody> </table>	Codice	Descrizione	Qtà	UM	RC1046A0	FASCETTA STRINGI TUBO D10-16 H9 INO	10	PZ												
Codice	Descrizione	Qtà	UM																						
RC1046A0	FASCETTA STRINGI TUBO D10-16 H9 INO	10	PZ																						
VL1096A	RACCORDO A T -2X PORTAGOMMA D6 - D10 E		KVL1096A	KIT 2PZ RACCORDO T-PORTAG D6-D10-MAGNETI	<table border="1"> <thead> <tr> <th>Codice</th> <th>Descrizione</th> <th>Qtà</th> <th>UM</th> </tr> </thead> <tbody> <tr> <td>RC1018A0</td> <td>FASCETTA ELASTICA D12 ZINCATA</td> <td>2</td> <td>PZ</td> </tr> <tr> <td>VL1086A0</td> <td>MAGNETE NEODIMIO ANTICALCARE</td> <td>2</td> <td>PZ</td> </tr> <tr> <td>VL1096A0</td> <td>RACCORDO A T-2X PORTAGOMMA A D6 - D10 E</td> <td>1</td> <td>PZ</td> </tr> <tr> <td>VL1096A1</td> <td>RACCORDO T -2X PORTAGOMMA A D6-D10 MAGNETI</td> <td>1</td> <td>PZ</td> </tr> </tbody> </table>	Codice	Descrizione	Qtà	UM	RC1018A0	FASCETTA ELASTICA D12 ZINCATA	2	PZ	VL1086A0	MAGNETE NEODIMIO ANTICALCARE	2	PZ	VL1096A0	RACCORDO A T-2X PORTAGOMMA A D6 - D10 E	1	PZ	VL1096A1	RACCORDO T -2X PORTAGOMMA A D6-D10 MAGNETI	1	PZ
Codice	Descrizione	Qtà	UM																						
RC1018A0	FASCETTA ELASTICA D12 ZINCATA	2	PZ																						
VL1086A0	MAGNETE NEODIMIO ANTICALCARE	2	PZ																						
VL1096A0	RACCORDO A T-2X PORTAGOMMA A D6 - D10 E	1	PZ																						
VL1096A1	RACCORDO T -2X PORTAGOMMA A D6-D10 MAGNETI	1	PZ																						
VM2450A	PASSAPARETE 3 TUBI		KVM2450A	KIT PASSAPARETE 3 TUBI	<table border="1"> <thead> <tr> <th>Codice</th> <th>Descrizione</th> <th>Qtà</th> <th>UM</th> </tr> </thead> <tbody> <tr> <td>VM2450A0</td> <td>PASSAPARETE E 3 TUBI</td> <td>1</td> <td>PZ</td> </tr> </tbody> </table>	Codice	Descrizione	Qtà	UM	VM2450A0	PASSAPARETE E 3 TUBI	1	PZ												
Codice	Descrizione	Qtà	UM																						
VM2450A0	PASSAPARETE E 3 TUBI	1	PZ																						

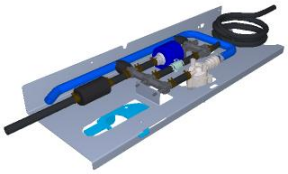

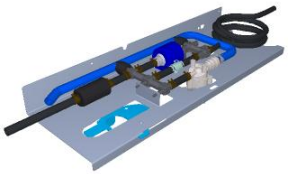
COMPONENTE			RICAMBIO																																																																						
Codice	Descrizione	Immagine	Codice	Descrizione	Lista componenti																																																																				
EL1438A	ELETTROVALVOLA DOPPIO CORPO 5+9 BARBED 6		KEL1438A	KIT ELETTROVALVOLA VAPORE 5+9 BARBED 6	<table border="1"> <thead> <tr> <th>Codice</th> <th>Descrizione</th> <th>Qtà</th> <th>UM</th> </tr> </thead> <tbody> <tr> <td>EL1438A0</td> <td>ELETTROVALV OLA DOPPIO CORPO 5+9 BARBED 6</td> <td>1</td> <td>PZ</td> </tr> </tbody> </table>	Codice	Descrizione	Qtà	UM	EL1438A0	ELETTROVALV OLA DOPPIO CORPO 5+9 BARBED 6	1	PZ																																																												
Codice	Descrizione	Qtà	UM																																																																						
EL1438A0	ELETTROVALV OLA DOPPIO CORPO 5+9 BARBED 6	1	PZ																																																																						
VL1106B	ASM LAVAGGIO ONE EU MONO GIRANTE		KVL1109A	KIT IMPIANTO LAVAGGIO ONE 2 GIRANTI EUR	<table border="1"> <thead> <tr> <th>Codice</th> <th>Descrizione</th> <th>Qtà</th> <th>UM</th> </tr> </thead> <tbody> <tr> <td>0H7324A0</td> <td>LAMIERA SUPPORTO LAVAGGIO ON</td> <td>2</td> <td>PZ</td> </tr> <tr> <td>0H7515A0</td> <td>LAMIERA DOPPIO LAVAGGIO XEVC-2011-E1</td> <td>1</td> <td>PZ</td> </tr> <tr> <td>CH1000A0</td> <td>TAGLIATUBI SNIP</td> <td>1</td> <td>PZ</td> </tr> <tr> <td>EL1115A0</td> <td>RACCORDO A Y Ø8 FEMMINA</td> <td>1</td> <td>PZ</td> </tr> <tr> <td>EL1436A0</td> <td>EV H2O JG D8-PORTAGO MMA D6 CHECK VALVE</td> <td>2</td> <td>PZ</td> </tr> <tr> <td>GN1526A0</td> <td>O-RING D.INT6.9 SP1.8</td> <td>2</td> <td>PZ</td> </tr> <tr> <td>RC1006A0</td> <td>CURVA GUIDA TUBO PET D8</td> <td>4</td> <td>PZ</td> </tr> <tr> <td>RC1019A0</td> <td>FASCETTA ELASTICA D10 ZINCATA</td> <td>30</td> <td>PZ</td> </tr> <tr> <td>RC1242A0</td> <td>TERMINALE CHIUSO D10</td> <td>4</td> <td>PZ</td> </tr> <tr> <td>TB1818A0</td> <td>TUBO 8X4.75 PE BLU</td> <td>1.640</td> <td>M</td> </tr> <tr> <td>TB2820A0</td> <td>TUBO EPDM 6X10</td> <td>2.760</td> <td>M</td> </tr> <tr> <td>VH1220A1</td> <td>VITE AUTOFILETTA NTE 4.2X11 TCS+ MARUTE</td> <td>8</td> <td>PZ</td> </tr> <tr> <td>VL1019A0</td> <td>POMPA VIBRAZIONE</td> <td>2</td> <td>PZ</td> </tr> <tr> <td>VL1053B0</td> <td>DISTRIBUTOR E USCITA LAVAGGIO ON</td> <td>2</td> <td>PZ</td> </tr> <tr> <td>VL1054B0</td> <td>DISTRIBUTOR E INGRESSI LAVAGGIO ON</td> <td>2</td> <td>PZ</td> </tr> <tr> <td>VL1080A0</td> <td>FILTRO IN LINEA DETERGENTE</td> <td>2</td> <td>PZ</td> </tr> </tbody> </table>	Codice	Descrizione	Qtà	UM	0H7324A0	LAMIERA SUPPORTO LAVAGGIO ON	2	PZ	0H7515A0	LAMIERA DOPPIO LAVAGGIO XEVC-2011-E1	1	PZ	CH1000A0	TAGLIATUBI SNIP	1	PZ	EL1115A0	RACCORDO A Y Ø8 FEMMINA	1	PZ	EL1436A0	EV H2O JG D8-PORTAGO MMA D6 CHECK VALVE	2	PZ	GN1526A0	O-RING D.INT6.9 SP1.8	2	PZ	RC1006A0	CURVA GUIDA TUBO PET D8	4	PZ	RC1019A0	FASCETTA ELASTICA D10 ZINCATA	30	PZ	RC1242A0	TERMINALE CHIUSO D10	4	PZ	TB1818A0	TUBO 8X4.75 PE BLU	1.640	M	TB2820A0	TUBO EPDM 6X10	2.760	M	VH1220A1	VITE AUTOFILETTA NTE 4.2X11 TCS+ MARUTE	8	PZ	VL1019A0	POMPA VIBRAZIONE	2	PZ	VL1053B0	DISTRIBUTOR E USCITA LAVAGGIO ON	2	PZ	VL1054B0	DISTRIBUTOR E INGRESSI LAVAGGIO ON	2	PZ	VL1080A0	FILTRO IN LINEA DETERGENTE	2	PZ
Codice	Descrizione	Qtà	UM																																																																						
0H7324A0	LAMIERA SUPPORTO LAVAGGIO ON	2	PZ																																																																						
0H7515A0	LAMIERA DOPPIO LAVAGGIO XEVC-2011-E1	1	PZ																																																																						
CH1000A0	TAGLIATUBI SNIP	1	PZ																																																																						
EL1115A0	RACCORDO A Y Ø8 FEMMINA	1	PZ																																																																						
EL1436A0	EV H2O JG D8-PORTAGO MMA D6 CHECK VALVE	2	PZ																																																																						
GN1526A0	O-RING D.INT6.9 SP1.8	2	PZ																																																																						
RC1006A0	CURVA GUIDA TUBO PET D8	4	PZ																																																																						
RC1019A0	FASCETTA ELASTICA D10 ZINCATA	30	PZ																																																																						
RC1242A0	TERMINALE CHIUSO D10	4	PZ																																																																						
TB1818A0	TUBO 8X4.75 PE BLU	1.640	M																																																																						
TB2820A0	TUBO EPDM 6X10	2.760	M																																																																						
VH1220A1	VITE AUTOFILETTA NTE 4.2X11 TCS+ MARUTE	8	PZ																																																																						
VL1019A0	POMPA VIBRAZIONE	2	PZ																																																																						
VL1053B0	DISTRIBUTOR E USCITA LAVAGGIO ON	2	PZ																																																																						
VL1054B0	DISTRIBUTOR E INGRESSI LAVAGGIO ON	2	PZ																																																																						
VL1080A0	FILTRO IN LINEA DETERGENTE	2	PZ																																																																						

COMPONENTE			RICAMBIO																																																							
Codice	Descrizione	Immagine	Codice	Descrizione	Lista componenti																																																					
VL1106B	ASM LAVAGGIO ONE EU MONO GIRANTE		KVL1109A	KIT IMPIANTO LAVAGGIO ONE 2 GIRANTI EUR	<table border="1"> <thead> <tr> <th>Codice</th> <th>Descrizione</th> <th>Qtà</th> <th>UM</th> </tr> </thead> <tbody> <tr> <td>VL1081A0</td> <td>VALVOLA NON RITORNO BARBED D6</td> <td>4</td> <td>PZ</td> </tr> <tr> <td>VL1102A0</td> <td>FILTRO IN LINEA CON VNR BARBED 6 MM</td> <td>2</td> <td>PZ</td> </tr> <tr> <td>VL1102A1</td> <td>FILTRO IN LINEA DET. + VNR BARBED 6 MM</td> <td>2</td> <td>PZ</td> </tr> <tr> <td>VL1128A0</td> <td>VALVOLA VNR BARBED D6</td> <td>2</td> <td>PZ</td> </tr> <tr> <td>VM2172A0</td> <td>CLIP BLOCCAGGIO POMPA CON CIRCUITO</td> <td>2</td> <td>PZ</td> </tr> </tbody> </table>	Codice	Descrizione	Qtà	UM	VL1081A0	VALVOLA NON RITORNO BARBED D6	4	PZ	VL1102A0	FILTRO IN LINEA CON VNR BARBED 6 MM	2	PZ	VL1102A1	FILTRO IN LINEA DET. + VNR BARBED 6 MM	2	PZ	VL1128A0	VALVOLA VNR BARBED D6	2	PZ	VM2172A0	CLIP BLOCCAGGIO POMPA CON CIRCUITO	2	PZ																													
			Codice	Descrizione	Qtà	UM																																																				
VL1081A0	VALVOLA NON RITORNO BARBED D6	4	PZ																																																							
VL1102A0	FILTRO IN LINEA CON VNR BARBED 6 MM	2	PZ																																																							
VL1102A1	FILTRO IN LINEA DET. + VNR BARBED 6 MM	2	PZ																																																							
VL1128A0	VALVOLA VNR BARBED D6	2	PZ																																																							
VM2172A0	CLIP BLOCCAGGIO POMPA CON CIRCUITO	2	PZ																																																							
KVL1106A	KIT IMPIANTO LAVAGGIO ONE 1 GIRANTE EUR	<table border="1"> <thead> <tr> <th>Codice</th> <th>Descrizione</th> <th>Qtà</th> <th>UM</th> </tr> </thead> <tbody> <tr> <td>0H7324A0</td> <td>LAMIERA SUPPORTO LAVAGGIO ON</td> <td>1</td> <td>PZ</td> </tr> <tr> <td>0H7819A0</td> <td>SUPPORTO LAVAGGIO ONE CON ELV STEAM</td> <td>1</td> <td>PZ</td> </tr> <tr> <td>EL1436A0</td> <td>EV H2O JG D8-PORTAGO MMA D6 CHECK VALVE</td> <td>1</td> <td>PZ</td> </tr> <tr> <td>GN1526A0</td> <td>O-RING D.INT6.9 SP1.8</td> <td>1</td> <td>PZ</td> </tr> <tr> <td>RC1006A0</td> <td>CURVA GUIDA TUBO PET D8</td> <td>2</td> <td>PZ</td> </tr> <tr> <td>RC1019A0</td> <td>FASCETTA ELASTICA D10 ZINCATA</td> <td>15</td> <td>PZ</td> </tr> <tr> <td>RC1242A0</td> <td>TERMINALE CHIUSO D10</td> <td>2</td> <td>PZ</td> </tr> <tr> <td>RC1408A0</td> <td>FASCETTA BIFILARE A MOLLA D10.8 TUBO ZN</td> <td>2</td> <td>PZ</td> </tr> <tr> <td>TB1818A0</td> <td>TUBO 8X4.75 PE BLU</td> <td>0.320</td> <td>M</td> </tr> <tr> <td>TB2820A0</td> <td>TUBO EPDM 6X10</td> <td>1.380</td> <td>M</td> </tr> <tr> <td>VI1220A1</td> <td>VITE AUTOFILETTA NTE 4.2X11 TCS+ MARUTE</td> <td>1</td> <td>PZ</td> </tr> <tr> <td>VL1019A0</td> <td>POMPA VIBRAZIONE</td> <td>1</td> <td>PZ</td> </tr> <tr> <td>VL1053B0</td> <td>DISTRIBUTOR E USCITA LAVAGGIO ON</td> <td>1</td> <td>PZ</td> </tr> </tbody> </table>	Codice	Descrizione	Qtà	UM	0H7324A0	LAMIERA SUPPORTO LAVAGGIO ON	1	PZ	0H7819A0	SUPPORTO LAVAGGIO ONE CON ELV STEAM	1	PZ	EL1436A0	EV H2O JG D8-PORTAGO MMA D6 CHECK VALVE	1	PZ	GN1526A0	O-RING D.INT6.9 SP1.8	1	PZ	RC1006A0	CURVA GUIDA TUBO PET D8	2	PZ	RC1019A0	FASCETTA ELASTICA D10 ZINCATA	15	PZ	RC1242A0	TERMINALE CHIUSO D10	2	PZ	RC1408A0	FASCETTA BIFILARE A MOLLA D10.8 TUBO ZN	2	PZ	TB1818A0	TUBO 8X4.75 PE BLU	0.320	M	TB2820A0	TUBO EPDM 6X10	1.380	M	VI1220A1	VITE AUTOFILETTA NTE 4.2X11 TCS+ MARUTE	1	PZ	VL1019A0	POMPA VIBRAZIONE	1	PZ	VL1053B0	DISTRIBUTOR E USCITA LAVAGGIO ON	1	PZ
Codice	Descrizione	Qtà	UM																																																							
0H7324A0	LAMIERA SUPPORTO LAVAGGIO ON	1	PZ																																																							
0H7819A0	SUPPORTO LAVAGGIO ONE CON ELV STEAM	1	PZ																																																							
EL1436A0	EV H2O JG D8-PORTAGO MMA D6 CHECK VALVE	1	PZ																																																							
GN1526A0	O-RING D.INT6.9 SP1.8	1	PZ																																																							
RC1006A0	CURVA GUIDA TUBO PET D8	2	PZ																																																							
RC1019A0	FASCETTA ELASTICA D10 ZINCATA	15	PZ																																																							
RC1242A0	TERMINALE CHIUSO D10	2	PZ																																																							
RC1408A0	FASCETTA BIFILARE A MOLLA D10.8 TUBO ZN	2	PZ																																																							
TB1818A0	TUBO 8X4.75 PE BLU	0.320	M																																																							
TB2820A0	TUBO EPDM 6X10	1.380	M																																																							
VI1220A1	VITE AUTOFILETTA NTE 4.2X11 TCS+ MARUTE	1	PZ																																																							
VL1019A0	POMPA VIBRAZIONE	1	PZ																																																							
VL1053B0	DISTRIBUTOR E USCITA LAVAGGIO ON	1	PZ																																																							

COMPONENTE			RICAMBIO																																		
Codice	Descrizione	Immagine	Codice	Descrizione	Lista componenti																																
VL1106B	ASM LAVAGGIO ONE EU MONO GIRANTE		KVL1106A	KIT IMPIANTO LAVAGGIO ONE 1 GIRANTE EUR	<table border="1"> <thead> <tr> <th>Codice</th> <th>Descrizione</th> <th>Qtà</th> <th>UM</th> </tr> </thead> <tbody> <tr> <td>VL1054B0</td> <td>DISTRIBUTOR E INGRESSI LAVAGGIO ON</td> <td>1</td> <td>PZ</td> </tr> <tr> <td>VL1080A0</td> <td>FILTRO IN LINEA DETERGENTE</td> <td>1</td> <td>PZ</td> </tr> <tr> <td>VL1081A0</td> <td>VALVOLA NON RITORNO BARBED D6</td> <td>1</td> <td>PZ</td> </tr> <tr> <td>VL1102A0</td> <td>FILTRO IN LINEA CON VNR BARBED 6 MM</td> <td>1</td> <td>PZ</td> </tr> <tr> <td>VL1102A1</td> <td>FILTRO IN LINEA DET. + VNR BARBED 6 MM</td> <td>1</td> <td>PZ</td> </tr> <tr> <td>VL1128A0</td> <td>VALVOLA VNR BARBED D6</td> <td>1</td> <td>PZ</td> </tr> <tr> <td>VM2172A0</td> <td>CLIP BLOCCAGGIO POMPA CON CIRCUITO</td> <td>1</td> <td>PZ</td> </tr> </tbody> </table>	Codice	Descrizione	Qtà	UM	VL1054B0	DISTRIBUTOR E INGRESSI LAVAGGIO ON	1	PZ	VL1080A0	FILTRO IN LINEA DETERGENTE	1	PZ	VL1081A0	VALVOLA NON RITORNO BARBED D6	1	PZ	VL1102A0	FILTRO IN LINEA CON VNR BARBED 6 MM	1	PZ	VL1102A1	FILTRO IN LINEA DET. + VNR BARBED 6 MM	1	PZ	VL1128A0	VALVOLA VNR BARBED D6	1	PZ	VM2172A0	CLIP BLOCCAGGIO POMPA CON CIRCUITO	1	PZ
Codice	Descrizione	Qtà	UM																																		
VL1054B0	DISTRIBUTOR E INGRESSI LAVAGGIO ON	1	PZ																																		
VL1080A0	FILTRO IN LINEA DETERGENTE	1	PZ																																		
VL1081A0	VALVOLA NON RITORNO BARBED D6	1	PZ																																		
VL1102A0	FILTRO IN LINEA CON VNR BARBED 6 MM	1	PZ																																		
VL1102A1	FILTRO IN LINEA DET. + VNR BARBED 6 MM	1	PZ																																		
VL1128A0	VALVOLA VNR BARBED D6	1	PZ																																		
VM2172A0	CLIP BLOCCAGGIO POMPA CON CIRCUITO	1	PZ																																		
RC1019A	FASCETTA ELASTICA D10 ZINCATA		KRC1019A	KIT 15 PZ. FASCETTA ELASTICA D10 ZINCATA	<table border="1"> <thead> <tr> <th>Codice</th> <th>Descrizione</th> <th>Qtà</th> <th>UM</th> </tr> </thead> <tbody> <tr> <td>RC1019A0</td> <td>FASCETTA ELASTICA D10 ZINCATA</td> <td>15</td> <td>PZ</td> </tr> </tbody> </table>	Codice	Descrizione	Qtà	UM	RC1019A0	FASCETTA ELASTICA D10 ZINCATA	15	PZ																								
Codice	Descrizione	Qtà	UM																																		
RC1019A0	FASCETTA ELASTICA D10 ZINCATA	15	PZ																																		
TB3007A	TB2820A-ROCCETTO DETERGENTE ONE PER GIR		KTB3007A	KIT ROCCETTO DETERGENTE ONE	<table border="1"> <thead> <tr> <th>Codice</th> <th>Descrizione</th> <th>Qtà</th> <th>UM</th> </tr> </thead> <tbody> <tr> <td>TB2820A0</td> <td>TUBO EPDM 6X10</td> <td>0.550</td> <td>M</td> </tr> </tbody> </table>	Codice	Descrizione	Qtà	UM	TB2820A0	TUBO EPDM 6X10	0.550	M																								
Codice	Descrizione	Qtà	UM																																		
TB2820A0	TUBO EPDM 6X10	0.550	M																																		
TB3225B	TB2820A-COLLEGAMENTO TANICA-GRUPPO LAVAG		TB3225B0	TB2820A-COLLEGAMENTO TANICA-GRUPPO LAVAG																																	

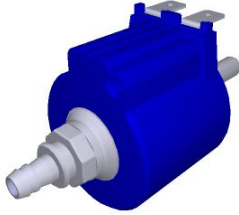
COMPONENTE			RICAMBIO																																																						
Codice	Descrizione	Immagine	Codice	Descrizione	Lista componenti																																																				
VL1047A	PORTAGOMMA D6 CODOLO D8		KVL1047A	KIT 10 PZ PORTAGOMMA D6 CODOLO D8	<table border="1"> <thead> <tr> <th>Codice</th> <th>Descrizione</th> <th>Qtà</th> <th>UM</th> </tr> </thead> <tbody> <tr> <td>VL1047A1</td> <td>PORTAGOMM A D6 CODOLO D8</td> <td>10</td> <td>PZ</td> </tr> </tbody> </table>	Codice	Descrizione	Qtà	UM	VL1047A1	PORTAGOMM A D6 CODOLO D8	10	PZ																																												
			Codice	Descrizione	Qtà	UM																																																			
VL1047A1	PORTAGOMM A D6 CODOLO D8	10	PZ																																																						
KVL0016A	KIT 260PZ ADATTAMENTO BRITA IMP.LAVAG M	<table border="1"> <thead> <tr> <th>Codice</th> <th>Descrizione</th> <th>Qtà</th> <th>UM</th> </tr> </thead> <tbody> <tr> <td>EL1185A0</td> <td>RACCORDO A GOMITO J.GUEST Ø8F - Ø8F</td> <td>1</td> <td>PZ</td> </tr> <tr> <td>RC1018A0</td> <td>FASCETTA ELASTICA D12 ZINCATA</td> <td>2</td> <td>PZ</td> </tr> <tr> <td>VL1047A1</td> <td>PORTAGOMM A D6 CODOLO D8</td> <td>2</td> <td>PZ</td> </tr> </tbody> </table>	Codice	Descrizione	Qtà	UM	EL1185A0	RACCORDO A GOMITO J.GUEST Ø8F - Ø8F	1	PZ	RC1018A0	FASCETTA ELASTICA D12 ZINCATA	2	PZ	VL1047A1	PORTAGOMM A D6 CODOLO D8	2	PZ																																							
Codice	Descrizione	Qtà	UM																																																						
EL1185A0	RACCORDO A GOMITO J.GUEST Ø8F - Ø8F	1	PZ																																																						
RC1018A0	FASCETTA ELASTICA D12 ZINCATA	2	PZ																																																						
VL1047A1	PORTAGOMM A D6 CODOLO D8	2	PZ																																																						
VL1019A	POMPA VIBRAZIONE		KVL1121A	KIT IMPIANTO LAVAGGIO CAPP MM EU	<table border="1"> <thead> <tr> <th>Codice</th> <th>Descrizione</th> <th>Qtà</th> <th>UM</th> </tr> </thead> <tbody> <tr> <td>0H7368A0</td> <td>LAMIERA IMPIANTO IDRICO CAPP S6</td> <td>1</td> <td>PZ</td> </tr> <tr> <td>EL1424A0</td> <td>ELETTROVALV OLA H2O JG D8-PORTAGO MMA D6</td> <td>1</td> <td>PZ</td> </tr> <tr> <td>EL1436A0</td> <td>EV H2O JG D8-PORTAGO MMA D6 CHECK VALVE</td> <td>1</td> <td>PZ</td> </tr> <tr> <td>GN1526A0</td> <td>O-RING D.INT6.9 SP1.8</td> <td>1</td> <td>PZ</td> </tr> <tr> <td>RC1018A0</td> <td>FASCETTA ELASTICA D12 ZINCATA</td> <td>4</td> <td>PZ</td> </tr> <tr> <td>RC1019A0</td> <td>FASCETTA ELASTICA D10 ZINCATA</td> <td>12</td> <td>PZ</td> </tr> <tr> <td>RC1242A0</td> <td>TERMINALE CHIUSO D10</td> <td>2</td> <td>PZ</td> </tr> <tr> <td>RC1408A0</td> <td>FASCETTA BIFILARE A MOLLA D10.8 TUBO ZN</td> <td>2</td> <td>PZ</td> </tr> <tr> <td>TB2820A0</td> <td>TUBO EPDM 6X10</td> <td>2.200</td> <td>M</td> </tr> <tr> <td>TB3132A0</td> <td>TUBO TELATO EPDM BIANCO-BLU 6X12</td> <td>0.540</td> <td>M</td> </tr> <tr> <td>VI1220A1</td> <td>VITE AUTOFILETTA NTE 4.2X11 TCS+ MARUTE</td> <td>5</td> <td>PZ</td> </tr> <tr> <td>VL1019A0</td> <td>POMPA VIBRAZIONE</td> <td>1</td> <td>PZ</td> </tr> </tbody> </table>	Codice	Descrizione	Qtà	UM	0H7368A0	LAMIERA IMPIANTO IDRICO CAPP S6	1	PZ	EL1424A0	ELETTROVALV OLA H2O JG D8-PORTAGO MMA D6	1	PZ	EL1436A0	EV H2O JG D8-PORTAGO MMA D6 CHECK VALVE	1	PZ	GN1526A0	O-RING D.INT6.9 SP1.8	1	PZ	RC1018A0	FASCETTA ELASTICA D12 ZINCATA	4	PZ	RC1019A0	FASCETTA ELASTICA D10 ZINCATA	12	PZ	RC1242A0	TERMINALE CHIUSO D10	2	PZ	RC1408A0	FASCETTA BIFILARE A MOLLA D10.8 TUBO ZN	2	PZ	TB2820A0	TUBO EPDM 6X10	2.200	M	TB3132A0	TUBO TELATO EPDM BIANCO-BLU 6X12	0.540	M	VI1220A1	VITE AUTOFILETTA NTE 4.2X11 TCS+ MARUTE	5	PZ	VL1019A0	POMPA VIBRAZIONE	1	PZ
			Codice	Descrizione	Qtà	UM																																																			
			0H7368A0	LAMIERA IMPIANTO IDRICO CAPP S6	1	PZ																																																			
			EL1424A0	ELETTROVALV OLA H2O JG D8-PORTAGO MMA D6	1	PZ																																																			
			EL1436A0	EV H2O JG D8-PORTAGO MMA D6 CHECK VALVE	1	PZ																																																			
			GN1526A0	O-RING D.INT6.9 SP1.8	1	PZ																																																			
			RC1018A0	FASCETTA ELASTICA D12 ZINCATA	4	PZ																																																			
			RC1019A0	FASCETTA ELASTICA D10 ZINCATA	12	PZ																																																			
			RC1242A0	TERMINALE CHIUSO D10	2	PZ																																																			
			RC1408A0	FASCETTA BIFILARE A MOLLA D10.8 TUBO ZN	2	PZ																																																			
			TB2820A0	TUBO EPDM 6X10	2.200	M																																																			
			TB3132A0	TUBO TELATO EPDM BIANCO-BLU 6X12	0.540	M																																																			
			VI1220A1	VITE AUTOFILETTA NTE 4.2X11 TCS+ MARUTE	5	PZ																																																			
			VL1019A0	POMPA VIBRAZIONE	1	PZ																																																			

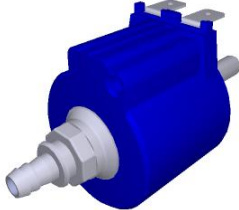
COMPONENTE			RICAMBIO																																										
Codice	Descrizione	Immagine	Codice	Descrizione	Lista componenti																																								
VL1019A	POMPA VIBRAZIONE		KVL1121A	KIT IMPIANTO LAVAGGIO CAPP MM EU	<table border="1"> <thead> <tr> <th>Codice</th> <th>Descrizione</th> <th>Qtà</th> <th>UM</th> </tr> </thead> <tbody> <tr> <td>VL1047A1</td> <td>PORTAGOMM A D6 CODOLO D8</td> <td>2</td> <td>PZ</td> </tr> <tr> <td>VL1053B0</td> <td>DISTRIBUTOR E USCITA LAVAGGIO ON</td> <td>1</td> <td>PZ</td> </tr> <tr> <td>VL1054B0</td> <td>DISTRIBUTOR E INGRESSI LAVAGGIO ON</td> <td>1</td> <td>PZ</td> </tr> <tr> <td>VL1102A1</td> <td>FILTRO IN LINEA DET. + VNR BARBED 6 MM</td> <td>1</td> <td>PZ</td> </tr> <tr> <td>VL1127A0</td> <td>RACCORDO A T BARBED 6</td> <td>1</td> <td>PZ</td> </tr> <tr> <td>VL1128A0</td> <td>VALVOLA VNR BARBED D6</td> <td>1</td> <td>PZ</td> </tr> <tr> <td>VM1605A0</td> <td>CLIP TWIST LOCK DIAM. 10,2-12,7 MM</td> <td>2</td> <td>PZ</td> </tr> <tr> <td>VM1610A0</td> <td>CLIP TWIST LOCK DIAM. 7,6-10,2 MM</td> <td>2</td> <td>PZ</td> </tr> <tr> <td>VM2172A0</td> <td>CLIP BLOCCAGGIO POMPA CON CIRCUITO</td> <td>1</td> <td>PZ</td> </tr> </tbody> </table>	Codice	Descrizione	Qtà	UM	VL1047A1	PORTAGOMM A D6 CODOLO D8	2	PZ	VL1053B0	DISTRIBUTOR E USCITA LAVAGGIO ON	1	PZ	VL1054B0	DISTRIBUTOR E INGRESSI LAVAGGIO ON	1	PZ	VL1102A1	FILTRO IN LINEA DET. + VNR BARBED 6 MM	1	PZ	VL1127A0	RACCORDO A T BARBED 6	1	PZ	VL1128A0	VALVOLA VNR BARBED D6	1	PZ	VM1605A0	CLIP TWIST LOCK DIAM. 10,2-12,7 MM	2	PZ	VM1610A0	CLIP TWIST LOCK DIAM. 7,6-10,2 MM	2	PZ	VM2172A0	CLIP BLOCCAGGIO POMPA CON CIRCUITO	1	PZ
Codice	Descrizione	Qtà	UM																																										
VL1047A1	PORTAGOMM A D6 CODOLO D8	2	PZ																																										
VL1053B0	DISTRIBUTOR E USCITA LAVAGGIO ON	1	PZ																																										
VL1054B0	DISTRIBUTOR E INGRESSI LAVAGGIO ON	1	PZ																																										
VL1102A1	FILTRO IN LINEA DET. + VNR BARBED 6 MM	1	PZ																																										
VL1127A0	RACCORDO A T BARBED 6	1	PZ																																										
VL1128A0	VALVOLA VNR BARBED D6	1	PZ																																										
VM1605A0	CLIP TWIST LOCK DIAM. 10,2-12,7 MM	2	PZ																																										
VM1610A0	CLIP TWIST LOCK DIAM. 7,6-10,2 MM	2	PZ																																										
VM2172A0	CLIP BLOCCAGGIO POMPA CON CIRCUITO	1	PZ																																										
			KVL1120A	KIT IMPIANTO LAVAGGIO PLUS COMPACT USA	<table border="1"> <thead> <tr> <th>Codice</th> <th>Descrizione</th> <th>Qtà</th> <th>UM</th> </tr> </thead> <tbody> <tr> <td>0H7553D0</td> <td>LAMIERA CIRCUITO LAVAGGIO XECC PLUS</td> <td>1</td> <td>PZ</td> </tr> <tr> <td>EL1422A1</td> <td>ELETTROVALV 1 VIA RID.VERDE JG D8-D10 UL</td> <td>1</td> <td>PZ</td> </tr> <tr> <td>EL1426A0</td> <td>ELETTROVALV OLA UL H2O JG D8-PORTAGO MMA D</td> <td>1</td> <td>PZ</td> </tr> <tr> <td>EL1437A0</td> <td>EV H2O JG D8-PORTAGO MMA D6 CH. VALVE UL</td> <td>1</td> <td>PZ</td> </tr> <tr> <td>GN1312A0</td> <td>PASSACAVO GOMMA DE=26 DI=15 SP=10</td> <td>1</td> <td>PZ</td> </tr> <tr> <td>GN1526A0</td> <td>O-RING D.INT6.9 SP1.8</td> <td>1</td> <td>PZ</td> </tr> <tr> <td>RC1019A0</td> <td>FASCETTA ELASTICA D10 ZINCATA</td> <td>8</td> <td>PZ</td> </tr> </tbody> </table>	Codice	Descrizione	Qtà	UM	0H7553D0	LAMIERA CIRCUITO LAVAGGIO XECC PLUS	1	PZ	EL1422A1	ELETTROVALV 1 VIA RID.VERDE JG D8-D10 UL	1	PZ	EL1426A0	ELETTROVALV OLA UL H2O JG D8-PORTAGO MMA D	1	PZ	EL1437A0	EV H2O JG D8-PORTAGO MMA D6 CH. VALVE UL	1	PZ	GN1312A0	PASSACAVO GOMMA DE=26 DI=15 SP=10	1	PZ	GN1526A0	O-RING D.INT6.9 SP1.8	1	PZ	RC1019A0	FASCETTA ELASTICA D10 ZINCATA	8	PZ								
Codice	Descrizione	Qtà	UM																																										
0H7553D0	LAMIERA CIRCUITO LAVAGGIO XECC PLUS	1	PZ																																										
EL1422A1	ELETTROVALV 1 VIA RID.VERDE JG D8-D10 UL	1	PZ																																										
EL1426A0	ELETTROVALV OLA UL H2O JG D8-PORTAGO MMA D	1	PZ																																										
EL1437A0	EV H2O JG D8-PORTAGO MMA D6 CH. VALVE UL	1	PZ																																										
GN1312A0	PASSACAVO GOMMA DE=26 DI=15 SP=10	1	PZ																																										
GN1526A0	O-RING D.INT6.9 SP1.8	1	PZ																																										
RC1019A0	FASCETTA ELASTICA D10 ZINCATA	8	PZ																																										

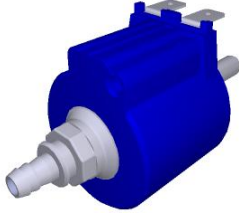
COMPONENTE			RICAMBIO																																																														
Codice	Descrizione	Immagine	Codice	Descrizione	Lista componenti																																																												
VL1019A	POMPA VIBRAZIONE		KVL1120A	KIT IMPIANTO LAVAGGIO PLUS COMPACT USA	<table border="1"> <thead> <tr> <th>Codice</th> <th>Descrizione</th> <th>Qtà</th> <th>UM</th> </tr> </thead> <tbody> <tr> <td>RC1242A0</td> <td>TERMINALE CHIUSO D10</td> <td>2</td> <td>PZ</td> </tr> <tr> <td>RC1356A0</td> <td>RACCORDO DRITTO FIL. FEMM 8X1/4 BSP</td> <td>1</td> <td>PZ</td> </tr> <tr> <td>RC1408A0</td> <td>FASCETTA BIFILARE A MOLLA D10,8 TUBO ZN</td> <td>2</td> <td>PZ</td> </tr> <tr> <td>TB2820A0</td> <td>TUBO EPDM 6X10</td> <td>1.200</td> <td>M</td> </tr> <tr> <td>VI1220A1</td> <td>VITE AUTOFILETTA NTE 4.2X11 TCS+ MARUTE</td> <td>9</td> <td>PZ</td> </tr> <tr> <td>VL1019A0</td> <td>POMPA VIBRAZIONE</td> <td>1</td> <td>PZ</td> </tr> <tr> <td>VL1054B0</td> <td>DISTRIBUTOR E INGRESSI LAVAGGIO ON</td> <td>1</td> <td>PZ</td> </tr> <tr> <td>VL1064A0</td> <td>DISTRIBUTOR E USCITE CIRCUITO LAVAGGIO PL</td> <td>1</td> <td>PZ</td> </tr> <tr> <td>VL1065A1</td> <td>PRESSOSTAT O.N.O. 1/4 M CI</td> <td>1</td> <td>PZ</td> </tr> <tr> <td>VL1081A0</td> <td>VALVOLA NON RITORNO BARBED D6</td> <td>1</td> <td>PZ</td> </tr> <tr> <td>VL1102A0</td> <td>FILTRO IN LINEA CON VNR BARBED 6 MM</td> <td>1</td> <td>PZ</td> </tr> <tr> <td>VL1102A1</td> <td>FILTRO IN LINEA DET. + VNR BARBED 6 MM</td> <td>1</td> <td>PZ</td> </tr> <tr> <td>VL1128A0</td> <td>VALVOLA VNR BARBED D6</td> <td>1</td> <td>PZ</td> </tr> <tr> <td>VM2172A0</td> <td>CLIP BLOCCAGGIO POMPA CON CIRCUITO</td> <td>1</td> <td>PZ</td> </tr> </tbody> </table>	Codice	Descrizione	Qtà	UM	RC1242A0	TERMINALE CHIUSO D10	2	PZ	RC1356A0	RACCORDO DRITTO FIL. FEMM 8X1/4 BSP	1	PZ	RC1408A0	FASCETTA BIFILARE A MOLLA D10,8 TUBO ZN	2	PZ	TB2820A0	TUBO EPDM 6X10	1.200	M	VI1220A1	VITE AUTOFILETTA NTE 4.2X11 TCS+ MARUTE	9	PZ	VL1019A0	POMPA VIBRAZIONE	1	PZ	VL1054B0	DISTRIBUTOR E INGRESSI LAVAGGIO ON	1	PZ	VL1064A0	DISTRIBUTOR E USCITE CIRCUITO LAVAGGIO PL	1	PZ	VL1065A1	PRESSOSTAT O.N.O. 1/4 M CI	1	PZ	VL1081A0	VALVOLA NON RITORNO BARBED D6	1	PZ	VL1102A0	FILTRO IN LINEA CON VNR BARBED 6 MM	1	PZ	VL1102A1	FILTRO IN LINEA DET. + VNR BARBED 6 MM	1	PZ	VL1128A0	VALVOLA VNR BARBED D6	1	PZ	VM2172A0	CLIP BLOCCAGGIO POMPA CON CIRCUITO	1	PZ
Codice	Descrizione	Qtà	UM																																																														
RC1242A0	TERMINALE CHIUSO D10	2	PZ																																																														
RC1356A0	RACCORDO DRITTO FIL. FEMM 8X1/4 BSP	1	PZ																																																														
RC1408A0	FASCETTA BIFILARE A MOLLA D10,8 TUBO ZN	2	PZ																																																														
TB2820A0	TUBO EPDM 6X10	1.200	M																																																														
VI1220A1	VITE AUTOFILETTA NTE 4.2X11 TCS+ MARUTE	9	PZ																																																														
VL1019A0	POMPA VIBRAZIONE	1	PZ																																																														
VL1054B0	DISTRIBUTOR E INGRESSI LAVAGGIO ON	1	PZ																																																														
VL1064A0	DISTRIBUTOR E USCITE CIRCUITO LAVAGGIO PL	1	PZ																																																														
VL1065A1	PRESSOSTAT O.N.O. 1/4 M CI	1	PZ																																																														
VL1081A0	VALVOLA NON RITORNO BARBED D6	1	PZ																																																														
VL1102A0	FILTRO IN LINEA CON VNR BARBED 6 MM	1	PZ																																																														
VL1102A1	FILTRO IN LINEA DET. + VNR BARBED 6 MM	1	PZ																																																														
VL1128A0	VALVOLA VNR BARBED D6	1	PZ																																																														
VM2172A0	CLIP BLOCCAGGIO POMPA CON CIRCUITO	1	PZ																																																														
			KVL1119A	KIT IMPIANTO LAVAGGIO PLUS COMPACT EUR	<table border="1"> <thead> <tr> <th>Codice</th> <th>Descrizione</th> <th>Qtà</th> <th>UM</th> </tr> </thead> <tbody> <tr> <td>0H7553C0</td> <td>LAMIERA CIRCUITO LAVAGGIO XECC PLUS</td> <td>1</td> <td>PZ</td> </tr> <tr> <td>0H7553D0</td> <td>LAMIERA CIRCUITO LAVAGGIO XECC PLUS</td> <td>1</td> <td>PZ</td> </tr> </tbody> </table>	Codice	Descrizione	Qtà	UM	0H7553C0	LAMIERA CIRCUITO LAVAGGIO XECC PLUS	1	PZ	0H7553D0	LAMIERA CIRCUITO LAVAGGIO XECC PLUS	1	PZ																																																
Codice	Descrizione	Qtà	UM																																																														
0H7553C0	LAMIERA CIRCUITO LAVAGGIO XECC PLUS	1	PZ																																																														
0H7553D0	LAMIERA CIRCUITO LAVAGGIO XECC PLUS	1	PZ																																																														

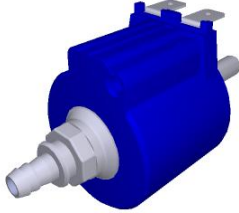
COMPONENTE			RICAMBIO																																																																														
Codice	Descrizione	Immagine	Codice	Descrizione	Lista componenti																																																																												
VL1019A	POMPA VIBRAZIONE		KVL1119A	KIT IMPIANTO LAVAGGIO PLUS COMPACT EUR	<table border="1"> <thead> <tr> <th>Codice</th> <th>Descrizione</th> <th>Qtà</th> <th>UM</th> </tr> </thead> <tbody> <tr> <td>EL1252A1</td> <td>ELETTROVALV OLA 1 VIA RID.VERDE JG D8-D10</td> <td>1</td> <td>PZ</td> </tr> <tr> <td>EL1424A0</td> <td>ELETTROVALV OLA H2O JG D8-PORTAGO MMA D6</td> <td>1</td> <td>PZ</td> </tr> <tr> <td>EL1436A0</td> <td>EV H2O JG D8-PORTAGO MMA D6 CHECK VALVE</td> <td>1</td> <td>PZ</td> </tr> <tr> <td>GN1312A0</td> <td>PASSACAVO GOMMA DE=26 DI=15 SP=10</td> <td>1</td> <td>PZ</td> </tr> <tr> <td>GN1526A0</td> <td>O-RING D.INT6.9 SP1.8</td> <td>1</td> <td>PZ</td> </tr> <tr> <td>RC1006A0</td> <td>CURVA GUIDA TUBO PET D8</td> <td>2</td> <td>PZ</td> </tr> <tr> <td>RC1019A0</td> <td>FASCETTA ELASTICA D10 ZINCATA</td> <td>9</td> <td>PZ</td> </tr> <tr> <td>RC1242A0</td> <td>TERMINALE CHIUSO D10</td> <td>2</td> <td>PZ</td> </tr> <tr> <td>RC1356A0</td> <td>RACCORDO DRITTO FIL. FEMM 8X1/4 BSP</td> <td>1</td> <td>PZ</td> </tr> <tr> <td>RC1408A0</td> <td>FASCETTA BIFILARE A MOLLA D10.8 TUBO ZN</td> <td>2</td> <td>PZ</td> </tr> <tr> <td>TB1818A0</td> <td>TUBO 8X4.75 PE BLU</td> <td>0.680</td> <td>M</td> </tr> <tr> <td>TB2820A0</td> <td>TUBO EPDM 6X10</td> <td>1.700</td> <td>M</td> </tr> <tr> <td>VH1220A1</td> <td>VITE AUTOFILETTA NTE 4.2X11 TCS+ MARUTE</td> <td>10</td> <td>PZ</td> </tr> <tr> <td>VL1019A0</td> <td>POMPA VIBRAZIONE</td> <td>1</td> <td>PZ</td> </tr> <tr> <td>VL1054B0</td> <td>DISTRIBUTOR E INGRESSI LAVAGGIO ON</td> <td>1</td> <td>PZ</td> </tr> <tr> <td>VL1064A0</td> <td>DISTRIBUTOR E USCITE CIRCUITO LAVAGGIO PL</td> <td>1</td> <td>PZ</td> </tr> <tr> <td>VL1065A1</td> <td>PRESSOSTAT O.N.O. 1/4 M CI</td> <td>1</td> <td>PZ</td> </tr> <tr> <td>VL1081A0</td> <td>VALVOLA NON RITORNO BARBED D6</td> <td>1</td> <td>PZ</td> </tr> </tbody> </table>	Codice	Descrizione	Qtà	UM	EL1252A1	ELETTROVALV OLA 1 VIA RID.VERDE JG D8-D10	1	PZ	EL1424A0	ELETTROVALV OLA H2O JG D8-PORTAGO MMA D6	1	PZ	EL1436A0	EV H2O JG D8-PORTAGO MMA D6 CHECK VALVE	1	PZ	GN1312A0	PASSACAVO GOMMA DE=26 DI=15 SP=10	1	PZ	GN1526A0	O-RING D.INT6.9 SP1.8	1	PZ	RC1006A0	CURVA GUIDA TUBO PET D8	2	PZ	RC1019A0	FASCETTA ELASTICA D10 ZINCATA	9	PZ	RC1242A0	TERMINALE CHIUSO D10	2	PZ	RC1356A0	RACCORDO DRITTO FIL. FEMM 8X1/4 BSP	1	PZ	RC1408A0	FASCETTA BIFILARE A MOLLA D10.8 TUBO ZN	2	PZ	TB1818A0	TUBO 8X4.75 PE BLU	0.680	M	TB2820A0	TUBO EPDM 6X10	1.700	M	VH1220A1	VITE AUTOFILETTA NTE 4.2X11 TCS+ MARUTE	10	PZ	VL1019A0	POMPA VIBRAZIONE	1	PZ	VL1054B0	DISTRIBUTOR E INGRESSI LAVAGGIO ON	1	PZ	VL1064A0	DISTRIBUTOR E USCITE CIRCUITO LAVAGGIO PL	1	PZ	VL1065A1	PRESSOSTAT O.N.O. 1/4 M CI	1	PZ	VL1081A0	VALVOLA NON RITORNO BARBED D6	1	PZ
Codice	Descrizione	Qtà	UM																																																																														
EL1252A1	ELETTROVALV OLA 1 VIA RID.VERDE JG D8-D10	1	PZ																																																																														
EL1424A0	ELETTROVALV OLA H2O JG D8-PORTAGO MMA D6	1	PZ																																																																														
EL1436A0	EV H2O JG D8-PORTAGO MMA D6 CHECK VALVE	1	PZ																																																																														
GN1312A0	PASSACAVO GOMMA DE=26 DI=15 SP=10	1	PZ																																																																														
GN1526A0	O-RING D.INT6.9 SP1.8	1	PZ																																																																														
RC1006A0	CURVA GUIDA TUBO PET D8	2	PZ																																																																														
RC1019A0	FASCETTA ELASTICA D10 ZINCATA	9	PZ																																																																														
RC1242A0	TERMINALE CHIUSO D10	2	PZ																																																																														
RC1356A0	RACCORDO DRITTO FIL. FEMM 8X1/4 BSP	1	PZ																																																																														
RC1408A0	FASCETTA BIFILARE A MOLLA D10.8 TUBO ZN	2	PZ																																																																														
TB1818A0	TUBO 8X4.75 PE BLU	0.680	M																																																																														
TB2820A0	TUBO EPDM 6X10	1.700	M																																																																														
VH1220A1	VITE AUTOFILETTA NTE 4.2X11 TCS+ MARUTE	10	PZ																																																																														
VL1019A0	POMPA VIBRAZIONE	1	PZ																																																																														
VL1054B0	DISTRIBUTOR E INGRESSI LAVAGGIO ON	1	PZ																																																																														
VL1064A0	DISTRIBUTOR E USCITE CIRCUITO LAVAGGIO PL	1	PZ																																																																														
VL1065A1	PRESSOSTAT O.N.O. 1/4 M CI	1	PZ																																																																														
VL1081A0	VALVOLA NON RITORNO BARBED D6	1	PZ																																																																														

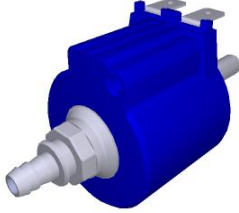
COMPONENTE			RICAMBIO																																																		
Codice	Descrizione	Immagine	Codice	Descrizione	Lista componenti																																																
VL1019A	POMPA VIBRAZIONE		KVL1119A	KIT IMPIANTO LAVAGGIO PLUS COMPACT EUR	<table border="1"> <thead> <tr> <th>Codice</th> <th>Descrizione</th> <th>Qtà</th> <th>UM</th> </tr> </thead> <tbody> <tr> <td>VL1083A0</td> <td>RACCORDO D10 - PORTAGOMM A BARBED D6</td> <td>1</td> <td>PZ</td> </tr> <tr> <td>VL1102A0</td> <td>FILTRO IN LINEA CON VNR BARBED 6 MM</td> <td>1</td> <td>PZ</td> </tr> <tr> <td>VL1102A1</td> <td>FILTRO IN LINEA DET. + VNR BARBED 6 MM</td> <td>1</td> <td>PZ</td> </tr> <tr> <td>VL1128A0</td> <td>VALVOLA VNR BARBED D6</td> <td>1</td> <td>PZ</td> </tr> <tr> <td>VM1610A0</td> <td>CLIP TWIST LOCK DIAM. 7,6-10,2 MM</td> <td>3</td> <td>PZ</td> </tr> <tr> <td>VM2172A0</td> <td>CLIP BLOCCAGGIO POMPA CON CIRCUITO</td> <td>1</td> <td>PZ</td> </tr> </tbody> </table>	Codice	Descrizione	Qtà	UM	VL1083A0	RACCORDO D10 - PORTAGOMM A BARBED D6	1	PZ	VL1102A0	FILTRO IN LINEA CON VNR BARBED 6 MM	1	PZ	VL1102A1	FILTRO IN LINEA DET. + VNR BARBED 6 MM	1	PZ	VL1128A0	VALVOLA VNR BARBED D6	1	PZ	VM1610A0	CLIP TWIST LOCK DIAM. 7,6-10,2 MM	3	PZ	VM2172A0	CLIP BLOCCAGGIO POMPA CON CIRCUITO	1	PZ																				
Codice	Descrizione	Qtà	UM																																																		
VL1083A0	RACCORDO D10 - PORTAGOMM A BARBED D6	1	PZ																																																		
VL1102A0	FILTRO IN LINEA CON VNR BARBED 6 MM	1	PZ																																																		
VL1102A1	FILTRO IN LINEA DET. + VNR BARBED 6 MM	1	PZ																																																		
VL1128A0	VALVOLA VNR BARBED D6	1	PZ																																																		
VM1610A0	CLIP TWIST LOCK DIAM. 7,6-10,2 MM	3	PZ																																																		
VM2172A0	CLIP BLOCCAGGIO POMPA CON CIRCUITO	1	PZ																																																		
			KVL1118A	KIT IMPIANTO LAVAGGIO ONE COMPACT EUR	<table border="1"> <thead> <tr> <th>Codice</th> <th>Descrizione</th> <th>Qtà</th> <th>UM</th> </tr> </thead> <tbody> <tr> <td>0H7173C0</td> <td>LAMIERA CIRCUITO LAVAGGIO XECC ONE</td> <td>1</td> <td>PZ</td> </tr> <tr> <td>EL1436A0</td> <td>EV H2O JG D8-PORTAGO MMA D6 CHECK VALVE</td> <td>1</td> <td>PZ</td> </tr> <tr> <td>GN1526A0</td> <td>O-RING D.INT6.9 SP1.8</td> <td>1</td> <td>PZ</td> </tr> <tr> <td>RC1019A0</td> <td>FASCETTA ELASTICA D10 ZINCATA</td> <td>10</td> <td>PZ</td> </tr> <tr> <td>RC1242A0</td> <td>TERMINALE CHIUSO D10</td> <td>2</td> <td>PZ</td> </tr> <tr> <td>RC1408A0</td> <td>FASCETTA BIFILARE A MOLLA D10.8 TUBO ZN</td> <td>2</td> <td>PZ</td> </tr> <tr> <td>TB2820A0</td> <td>TUBO EPDM 6X10</td> <td>1.200</td> <td>M</td> </tr> <tr> <td>VI1220A1</td> <td>VITE AUTOFILETTA NTE 4.2X11 TCS+ MARUTE</td> <td>6</td> <td>PZ</td> </tr> <tr> <td>VL1019A0</td> <td>POMPA VIBRAZIONE</td> <td>1</td> <td>PZ</td> </tr> <tr> <td>VL1053B0</td> <td>DISTRIBUTOR E USCITA LAVAGGIO ON</td> <td>1</td> <td>PZ</td> </tr> <tr> <td>VL1054B0</td> <td>DISTRIBUTOR E INGRESSI LAVAGGIO ON</td> <td>1</td> <td>PZ</td> </tr> </tbody> </table>	Codice	Descrizione	Qtà	UM	0H7173C0	LAMIERA CIRCUITO LAVAGGIO XECC ONE	1	PZ	EL1436A0	EV H2O JG D8-PORTAGO MMA D6 CHECK VALVE	1	PZ	GN1526A0	O-RING D.INT6.9 SP1.8	1	PZ	RC1019A0	FASCETTA ELASTICA D10 ZINCATA	10	PZ	RC1242A0	TERMINALE CHIUSO D10	2	PZ	RC1408A0	FASCETTA BIFILARE A MOLLA D10.8 TUBO ZN	2	PZ	TB2820A0	TUBO EPDM 6X10	1.200	M	VI1220A1	VITE AUTOFILETTA NTE 4.2X11 TCS+ MARUTE	6	PZ	VL1019A0	POMPA VIBRAZIONE	1	PZ	VL1053B0	DISTRIBUTOR E USCITA LAVAGGIO ON	1	PZ	VL1054B0	DISTRIBUTOR E INGRESSI LAVAGGIO ON	1	PZ
Codice	Descrizione	Qtà	UM																																																		
0H7173C0	LAMIERA CIRCUITO LAVAGGIO XECC ONE	1	PZ																																																		
EL1436A0	EV H2O JG D8-PORTAGO MMA D6 CHECK VALVE	1	PZ																																																		
GN1526A0	O-RING D.INT6.9 SP1.8	1	PZ																																																		
RC1019A0	FASCETTA ELASTICA D10 ZINCATA	10	PZ																																																		
RC1242A0	TERMINALE CHIUSO D10	2	PZ																																																		
RC1408A0	FASCETTA BIFILARE A MOLLA D10.8 TUBO ZN	2	PZ																																																		
TB2820A0	TUBO EPDM 6X10	1.200	M																																																		
VI1220A1	VITE AUTOFILETTA NTE 4.2X11 TCS+ MARUTE	6	PZ																																																		
VL1019A0	POMPA VIBRAZIONE	1	PZ																																																		
VL1053B0	DISTRIBUTOR E USCITA LAVAGGIO ON	1	PZ																																																		
VL1054B0	DISTRIBUTOR E INGRESSI LAVAGGIO ON	1	PZ																																																		

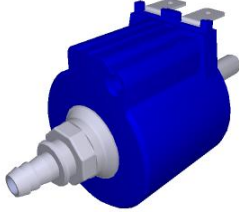

COMPONENTE			RICAMBIO																																																														
Codice	Descrizione	Immagine	Codice	Descrizione	Lista componenti																																																												
VL1019A	POMPA VIBRAZIONE		KVL1118A	KIT IMPIANTO LAVAGGIO ONE COMPACT EUR	<table border="1"> <thead> <tr> <th>Codice</th> <th>Descrizione</th> <th>Qtà</th> <th>UM</th> </tr> </thead> <tbody> <tr> <td>VL1081A0</td> <td>VALVOLA NON RITORNO BARBED D6</td> <td>1</td> <td>PZ</td> </tr> <tr> <td>VL1102A0</td> <td>FILTRO IN LINEA CON VNR BARBED 6 MM</td> <td>1</td> <td>PZ</td> </tr> <tr> <td>VL1102A1</td> <td>FILTRO IN LINEA DET. + VNR BARBED 6 MM</td> <td>1</td> <td>PZ</td> </tr> <tr> <td>VL1128A0</td> <td>VALVOLA VNR BARBED D6</td> <td>1</td> <td>PZ</td> </tr> <tr> <td>VM2172A0</td> <td>CLIP BLOCCAGGIO POMPA CON CIRCUITO</td> <td>1</td> <td>PZ</td> </tr> </tbody> </table>	Codice	Descrizione	Qtà	UM	VL1081A0	VALVOLA NON RITORNO BARBED D6	1	PZ	VL1102A0	FILTRO IN LINEA CON VNR BARBED 6 MM	1	PZ	VL1102A1	FILTRO IN LINEA DET. + VNR BARBED 6 MM	1	PZ	VL1128A0	VALVOLA VNR BARBED D6	1	PZ	VM2172A0	CLIP BLOCCAGGIO POMPA CON CIRCUITO	1	PZ																																				
Codice	Descrizione	Qtà	UM																																																														
VL1081A0	VALVOLA NON RITORNO BARBED D6	1	PZ																																																														
VL1102A0	FILTRO IN LINEA CON VNR BARBED 6 MM	1	PZ																																																														
VL1102A1	FILTRO IN LINEA DET. + VNR BARBED 6 MM	1	PZ																																																														
VL1128A0	VALVOLA VNR BARBED D6	1	PZ																																																														
VM2172A0	CLIP BLOCCAGGIO POMPA CON CIRCUITO	1	PZ																																																														
			KVL1109A	KIT IMPIANTO LAVAGGIO ONE 2 GIRANTI EUR	<table border="1"> <thead> <tr> <th>Codice</th> <th>Descrizione</th> <th>Qtà</th> <th>UM</th> </tr> </thead> <tbody> <tr> <td>0H7324A0</td> <td>LAMIERA SUPPORTO LAVAGGIO ON</td> <td>2</td> <td>PZ</td> </tr> <tr> <td>0H7515A0</td> <td>LAMIERA DOPPIO LAVAGGIO XEVC-2011-E1</td> <td>1</td> <td>PZ</td> </tr> <tr> <td>CH1000A0</td> <td>TAGLIATUBI SNIP</td> <td>1</td> <td>PZ</td> </tr> <tr> <td>EL1115A0</td> <td>RACCORDO A Y Ø8 FEMMINA</td> <td>1</td> <td>PZ</td> </tr> <tr> <td>EL1436A0</td> <td>EV H2O JG D8-PORTAGO MMA D6 CHECK VALVE</td> <td>2</td> <td>PZ</td> </tr> <tr> <td>GN1526A0</td> <td>O-RING D.INT6.9 SP1.8</td> <td>2</td> <td>PZ</td> </tr> <tr> <td>RC1006A0</td> <td>CURVA GUIDA TUBO PET D8</td> <td>4</td> <td>PZ</td> </tr> <tr> <td>RC1019A0</td> <td>FASCETTA ELASTICA D10 ZINCATA</td> <td>30</td> <td>PZ</td> </tr> <tr> <td>RC1242A0</td> <td>TERMINALE CHIUSO D10</td> <td>4</td> <td>PZ</td> </tr> <tr> <td>TB1818A0</td> <td>TUBO 8X4.75 PE BLU</td> <td>1.640</td> <td>M</td> </tr> <tr> <td>TB2820A0</td> <td>TUBO EPDM 6X10</td> <td>2.760</td> <td>M</td> </tr> <tr> <td>VI1220A1</td> <td>VITE AUTOFILETTA NTE 4.2X11 TCS+ MARUTE</td> <td>8</td> <td>PZ</td> </tr> <tr> <td>VL1019A0</td> <td>POMPA VIBRAZIONE</td> <td>2</td> <td>PZ</td> </tr> <tr> <td>VL1053B0</td> <td>DISTRIBUTOR E USCITA LAVAGGIO ON</td> <td>2</td> <td>PZ</td> </tr> </tbody> </table>	Codice	Descrizione	Qtà	UM	0H7324A0	LAMIERA SUPPORTO LAVAGGIO ON	2	PZ	0H7515A0	LAMIERA DOPPIO LAVAGGIO XEVC-2011-E1	1	PZ	CH1000A0	TAGLIATUBI SNIP	1	PZ	EL1115A0	RACCORDO A Y Ø8 FEMMINA	1	PZ	EL1436A0	EV H2O JG D8-PORTAGO MMA D6 CHECK VALVE	2	PZ	GN1526A0	O-RING D.INT6.9 SP1.8	2	PZ	RC1006A0	CURVA GUIDA TUBO PET D8	4	PZ	RC1019A0	FASCETTA ELASTICA D10 ZINCATA	30	PZ	RC1242A0	TERMINALE CHIUSO D10	4	PZ	TB1818A0	TUBO 8X4.75 PE BLU	1.640	M	TB2820A0	TUBO EPDM 6X10	2.760	M	VI1220A1	VITE AUTOFILETTA NTE 4.2X11 TCS+ MARUTE	8	PZ	VL1019A0	POMPA VIBRAZIONE	2	PZ	VL1053B0	DISTRIBUTOR E USCITA LAVAGGIO ON	2	PZ
Codice	Descrizione	Qtà	UM																																																														
0H7324A0	LAMIERA SUPPORTO LAVAGGIO ON	2	PZ																																																														
0H7515A0	LAMIERA DOPPIO LAVAGGIO XEVC-2011-E1	1	PZ																																																														
CH1000A0	TAGLIATUBI SNIP	1	PZ																																																														
EL1115A0	RACCORDO A Y Ø8 FEMMINA	1	PZ																																																														
EL1436A0	EV H2O JG D8-PORTAGO MMA D6 CHECK VALVE	2	PZ																																																														
GN1526A0	O-RING D.INT6.9 SP1.8	2	PZ																																																														
RC1006A0	CURVA GUIDA TUBO PET D8	4	PZ																																																														
RC1019A0	FASCETTA ELASTICA D10 ZINCATA	30	PZ																																																														
RC1242A0	TERMINALE CHIUSO D10	4	PZ																																																														
TB1818A0	TUBO 8X4.75 PE BLU	1.640	M																																																														
TB2820A0	TUBO EPDM 6X10	2.760	M																																																														
VI1220A1	VITE AUTOFILETTA NTE 4.2X11 TCS+ MARUTE	8	PZ																																																														
VL1019A0	POMPA VIBRAZIONE	2	PZ																																																														
VL1053B0	DISTRIBUTOR E USCITA LAVAGGIO ON	2	PZ																																																														

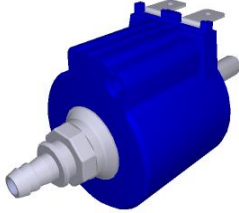
COMPONENTE			RICAMBIO																																														
Codice	Descrizione	Immagine	Codice	Descrizione	Lista componenti																																												
VL1019A	POMPA VIBRAZIONE		KVL1109A	KIT IMPIANTO LAVAGGIO ONE 2 GIRANTI EUR	<table border="1"> <thead> <tr> <th>Codice</th> <th>Descrizione</th> <th>Qtà</th> <th>UM</th> </tr> </thead> <tbody> <tr> <td>VL1054B0</td> <td>DISTRIBUTOR E INGRESSI LAVAGGIO ON</td> <td>2</td> <td>PZ</td> </tr> <tr> <td>VL1080A0</td> <td>FILTRO IN LINEA DETERGENTE</td> <td>2</td> <td>PZ</td> </tr> <tr> <td>VL1081A0</td> <td>VALVOLA NON RITORNO BARBED D6</td> <td>4</td> <td>PZ</td> </tr> <tr> <td>VL1102A0</td> <td>FILTRO IN LINEA CON VNR BARBED 6 MM</td> <td>2</td> <td>PZ</td> </tr> <tr> <td>VL1102A1</td> <td>FILTRO IN LINEA DET. + VNR BARBED 6 MM</td> <td>2</td> <td>PZ</td> </tr> <tr> <td>VL1128A0</td> <td>VALVOLA VNR BARBED D6</td> <td>2</td> <td>PZ</td> </tr> <tr> <td>VM2172A0</td> <td>CLIP BLOCCAGGIO POMPA CON CIRCUITO</td> <td>2</td> <td>PZ</td> </tr> </tbody> </table>	Codice	Descrizione	Qtà	UM	VL1054B0	DISTRIBUTOR E INGRESSI LAVAGGIO ON	2	PZ	VL1080A0	FILTRO IN LINEA DETERGENTE	2	PZ	VL1081A0	VALVOLA NON RITORNO BARBED D6	4	PZ	VL1102A0	FILTRO IN LINEA CON VNR BARBED 6 MM	2	PZ	VL1102A1	FILTRO IN LINEA DET. + VNR BARBED 6 MM	2	PZ	VL1128A0	VALVOLA VNR BARBED D6	2	PZ	VM2172A0	CLIP BLOCCAGGIO POMPA CON CIRCUITO	2	PZ												
Codice	Descrizione	Qtà	UM																																														
VL1054B0	DISTRIBUTOR E INGRESSI LAVAGGIO ON	2	PZ																																														
VL1080A0	FILTRO IN LINEA DETERGENTE	2	PZ																																														
VL1081A0	VALVOLA NON RITORNO BARBED D6	4	PZ																																														
VL1102A0	FILTRO IN LINEA CON VNR BARBED 6 MM	2	PZ																																														
VL1102A1	FILTRO IN LINEA DET. + VNR BARBED 6 MM	2	PZ																																														
VL1128A0	VALVOLA VNR BARBED D6	2	PZ																																														
VM2172A0	CLIP BLOCCAGGIO POMPA CON CIRCUITO	2	PZ																																														
			KVL1108A	KIT IMPIANTO LAVAGGIO ONE 04EU 1 GIR EUR	<table border="1"> <thead> <tr> <th>Codice</th> <th>Descrizione</th> <th>Qtà</th> <th>UM</th> </tr> </thead> <tbody> <tr> <td>0H7323A0</td> <td>LAMIERA SUPPORTO LAVAGGIO PLUS</td> <td>1</td> <td>PZ</td> </tr> <tr> <td>0H7511A0</td> <td>LAMIERA SUPPORTO LAVAGGIO ON</td> <td>1</td> <td>PZ</td> </tr> <tr> <td>EL1252A1</td> <td>ELETTROVALV OLA 1 VIA RID.VERDE JG D8-D10</td> <td>1</td> <td>PZ</td> </tr> <tr> <td>EL1424A0</td> <td>ELETTROVALV OLA H2O JG D8-PORTAGO MMA D6</td> <td>1</td> <td>PZ</td> </tr> <tr> <td>EL1436A0</td> <td>EV H2O JG D8-PORTAGO MMA D6 CHECK VALVE</td> <td>1</td> <td>PZ</td> </tr> <tr> <td>GN1526A0</td> <td>O-RING D.INT6.9 SP1.8</td> <td>1</td> <td>PZ</td> </tr> <tr> <td>RC1006A0</td> <td>CURVA GUIDA TUBO PET D8</td> <td>2</td> <td>PZ</td> </tr> <tr> <td>RC1019A0</td> <td>FASCETTA ELASTICA D10 ZINCATA</td> <td>11</td> <td>PZ</td> </tr> <tr> <td>RC1130A0</td> <td>FASCETTA 130X2,6</td> <td>1</td> <td>PZ</td> </tr> <tr> <td>RC1242A0</td> <td>TERMINALE CHIUSO D10</td> <td>2</td> <td>PZ</td> </tr> </tbody> </table>	Codice	Descrizione	Qtà	UM	0H7323A0	LAMIERA SUPPORTO LAVAGGIO PLUS	1	PZ	0H7511A0	LAMIERA SUPPORTO LAVAGGIO ON	1	PZ	EL1252A1	ELETTROVALV OLA 1 VIA RID.VERDE JG D8-D10	1	PZ	EL1424A0	ELETTROVALV OLA H2O JG D8-PORTAGO MMA D6	1	PZ	EL1436A0	EV H2O JG D8-PORTAGO MMA D6 CHECK VALVE	1	PZ	GN1526A0	O-RING D.INT6.9 SP1.8	1	PZ	RC1006A0	CURVA GUIDA TUBO PET D8	2	PZ	RC1019A0	FASCETTA ELASTICA D10 ZINCATA	11	PZ	RC1130A0	FASCETTA 130X2,6	1	PZ	RC1242A0	TERMINALE CHIUSO D10	2	PZ
Codice	Descrizione	Qtà	UM																																														
0H7323A0	LAMIERA SUPPORTO LAVAGGIO PLUS	1	PZ																																														
0H7511A0	LAMIERA SUPPORTO LAVAGGIO ON	1	PZ																																														
EL1252A1	ELETTROVALV OLA 1 VIA RID.VERDE JG D8-D10	1	PZ																																														
EL1424A0	ELETTROVALV OLA H2O JG D8-PORTAGO MMA D6	1	PZ																																														
EL1436A0	EV H2O JG D8-PORTAGO MMA D6 CHECK VALVE	1	PZ																																														
GN1526A0	O-RING D.INT6.9 SP1.8	1	PZ																																														
RC1006A0	CURVA GUIDA TUBO PET D8	2	PZ																																														
RC1019A0	FASCETTA ELASTICA D10 ZINCATA	11	PZ																																														
RC1130A0	FASCETTA 130X2,6	1	PZ																																														
RC1242A0	TERMINALE CHIUSO D10	2	PZ																																														

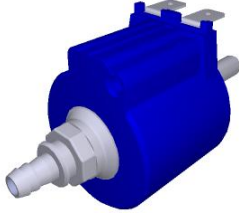
COMPONENTE			RICAMBIO																																																																										
Codice	Descrizione	Immagine	Codice	Descrizione	Lista componenti																																																																								
VL1019A	POMPA VIBRAZIONE		KVL1108A	KIT IMPIANTO LAVAGGIO ONE 04EU 1 GIR EUR	<table border="1"> <thead> <tr> <th>Codice</th> <th>Descrizione</th> <th>Qtà</th> <th>UM</th> </tr> </thead> <tbody> <tr> <td>RC1310A0</td> <td>FASCETTA RICHCO 140X4 CON CLIP</td> <td>2</td> <td>PZ</td> </tr> <tr> <td>RC1356A0</td> <td>RACCORDO DRITTO FIL. FEMM 8X1/4 BSP</td> <td>1</td> <td>PZ</td> </tr> <tr> <td>TB1818A0</td> <td>TUBO 8X4.75 PE BLU</td> <td>0.220</td> <td>M</td> </tr> <tr> <td>TB2820A0</td> <td>TUBO EPDM 6X10</td> <td>1.240</td> <td>M</td> </tr> <tr> <td>VI1220A1</td> <td>VITE AUTOFILETTA NTE 4.2X11 TCS+ MARUTE</td> <td>2</td> <td>PZ</td> </tr> <tr> <td>VL1019A0</td> <td>POMPA VIBRAZIONE</td> <td>1</td> <td>PZ</td> </tr> <tr> <td>VL1053B0</td> <td>DISTRIBUTOR E USCITA LAVAGGIO ON</td> <td>1</td> <td>PZ</td> </tr> <tr> <td>VL1054B0</td> <td>DISTRIBUTOR E INGRESSI LAVAGGIO ON</td> <td>1</td> <td>PZ</td> </tr> <tr> <td>VL1064A0</td> <td>DISTRIBUTOR E USCITE CIRCUITO LAVAGGIO PL</td> <td>1</td> <td>PZ</td> </tr> <tr> <td>VL1065A1</td> <td>PRESSOSTAT O.N.O. 1/4 M CI</td> <td>1</td> <td>PZ</td> </tr> <tr> <td>VL1067A0</td> <td>DISTRIBUTOR E INGRESSI CIRCUITO LAVAGGIO</td> <td>1</td> <td>PZ</td> </tr> <tr> <td>VL1080A0</td> <td>FILTRO IN LINEA DETERGENTE</td> <td>1</td> <td>PZ</td> </tr> <tr> <td>VL1081A0</td> <td>VALVOLA NON RITORNO BARBED D6</td> <td>2</td> <td>PZ</td> </tr> <tr> <td>VL1083A0</td> <td>RACCORDO D10 - PORTAGOMM A BARBED D6</td> <td>1</td> <td>PZ</td> </tr> <tr> <td>VL1102A0</td> <td>FILTRO IN LINEA CON VNR BARBED 6 MM</td> <td>1</td> <td>PZ</td> </tr> <tr> <td>VL1128A0</td> <td>VALVOLA VNR BARBED D6</td> <td>1</td> <td>PZ</td> </tr> <tr> <td>VM2172A0</td> <td>CLIP BLOCCAGGIO POMPA CON CIRCUITO</td> <td>1</td> <td>PZ</td> </tr> </tbody> </table>	Codice	Descrizione	Qtà	UM	RC1310A0	FASCETTA RICHCO 140X4 CON CLIP	2	PZ	RC1356A0	RACCORDO DRITTO FIL. FEMM 8X1/4 BSP	1	PZ	TB1818A0	TUBO 8X4.75 PE BLU	0.220	M	TB2820A0	TUBO EPDM 6X10	1.240	M	VI1220A1	VITE AUTOFILETTA NTE 4.2X11 TCS+ MARUTE	2	PZ	VL1019A0	POMPA VIBRAZIONE	1	PZ	VL1053B0	DISTRIBUTOR E USCITA LAVAGGIO ON	1	PZ	VL1054B0	DISTRIBUTOR E INGRESSI LAVAGGIO ON	1	PZ	VL1064A0	DISTRIBUTOR E USCITE CIRCUITO LAVAGGIO PL	1	PZ	VL1065A1	PRESSOSTAT O.N.O. 1/4 M CI	1	PZ	VL1067A0	DISTRIBUTOR E INGRESSI CIRCUITO LAVAGGIO	1	PZ	VL1080A0	FILTRO IN LINEA DETERGENTE	1	PZ	VL1081A0	VALVOLA NON RITORNO BARBED D6	2	PZ	VL1083A0	RACCORDO D10 - PORTAGOMM A BARBED D6	1	PZ	VL1102A0	FILTRO IN LINEA CON VNR BARBED 6 MM	1	PZ	VL1128A0	VALVOLA VNR BARBED D6	1	PZ	VM2172A0	CLIP BLOCCAGGIO POMPA CON CIRCUITO	1	PZ
Codice	Descrizione	Qtà	UM																																																																										
RC1310A0	FASCETTA RICHCO 140X4 CON CLIP	2	PZ																																																																										
RC1356A0	RACCORDO DRITTO FIL. FEMM 8X1/4 BSP	1	PZ																																																																										
TB1818A0	TUBO 8X4.75 PE BLU	0.220	M																																																																										
TB2820A0	TUBO EPDM 6X10	1.240	M																																																																										
VI1220A1	VITE AUTOFILETTA NTE 4.2X11 TCS+ MARUTE	2	PZ																																																																										
VL1019A0	POMPA VIBRAZIONE	1	PZ																																																																										
VL1053B0	DISTRIBUTOR E USCITA LAVAGGIO ON	1	PZ																																																																										
VL1054B0	DISTRIBUTOR E INGRESSI LAVAGGIO ON	1	PZ																																																																										
VL1064A0	DISTRIBUTOR E USCITE CIRCUITO LAVAGGIO PL	1	PZ																																																																										
VL1065A1	PRESSOSTAT O.N.O. 1/4 M CI	1	PZ																																																																										
VL1067A0	DISTRIBUTOR E INGRESSI CIRCUITO LAVAGGIO	1	PZ																																																																										
VL1080A0	FILTRO IN LINEA DETERGENTE	1	PZ																																																																										
VL1081A0	VALVOLA NON RITORNO BARBED D6	2	PZ																																																																										
VL1083A0	RACCORDO D10 - PORTAGOMM A BARBED D6	1	PZ																																																																										
VL1102A0	FILTRO IN LINEA CON VNR BARBED 6 MM	1	PZ																																																																										
VL1128A0	VALVOLA VNR BARBED D6	1	PZ																																																																										
VM2172A0	CLIP BLOCCAGGIO POMPA CON CIRCUITO	1	PZ																																																																										

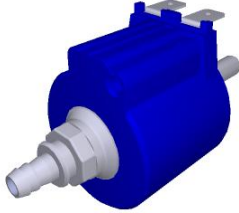
COMPONENTE			RICAMBIO																																																																										
Codice	Descrizione	Immagine	Codice	Descrizione	Lista componenti																																																																								
VL1019A	POMPA VIBRAZIONE		KVL1107A	KIT IMPIANTO LAVAGGIO PLUS 04EU 1 GIR EU	<table border="1"> <thead> <tr> <th>Codice</th> <th>Descrizione</th> <th>Qtà</th> <th>UM</th> </tr> </thead> <tbody> <tr> <td>0H7323A0</td> <td>LAMIERA SUPPORTO LAVAGGIO PLUS</td> <td>1</td> <td>PZ</td> </tr> <tr> <td>EL1252A1</td> <td>ELETTROVALV OLA 1 VIA RID.VERDE JG D8-D10</td> <td>1</td> <td>PZ</td> </tr> <tr> <td>EL1424A0</td> <td>ELETTROVALV OLA H2O JG D8-PORTAGO MMA D6</td> <td>1</td> <td>PZ</td> </tr> <tr> <td>EL1436A0</td> <td>EV H2O JG D8-PORTAGO MMA D6 CHECK VALVE</td> <td>1</td> <td>PZ</td> </tr> <tr> <td>GN1526A0</td> <td>O-RING D.INT6.9 SP1.8</td> <td>1</td> <td>PZ</td> </tr> <tr> <td>RC1019A0</td> <td>FASCETTA ELASTICA D10 ZINCATA</td> <td>11</td> <td>PZ</td> </tr> <tr> <td>RC1130A0</td> <td>FASCETTA 130X2,6</td> <td>1</td> <td>PZ</td> </tr> <tr> <td>RC1242A0</td> <td>TERMINALE CHIUSO D10</td> <td>2</td> <td>PZ</td> </tr> <tr> <td>RC1310A0</td> <td>FASCETTA RICHCO 140X4 CON CLIP</td> <td>2</td> <td>PZ</td> </tr> <tr> <td>RC1356A0</td> <td>RACCORDO DRITTO FIL. FEMM 8X1/4 BSP</td> <td>1</td> <td>PZ</td> </tr> <tr> <td>TB2820A0</td> <td>TUBO EPDM 6X10</td> <td>2.040</td> <td>M</td> </tr> <tr> <td>VI1220A1</td> <td>VITE AUTOFILETTA NTE 4.2X11 TCS+ MARUTE</td> <td>2</td> <td>PZ</td> </tr> <tr> <td>VL1019A0</td> <td>POMPA VIBRAZIONE</td> <td>1</td> <td>PZ</td> </tr> <tr> <td>VL1064A0</td> <td>DISTRIBUTOR E USCITE CIRCUITO LAVAGGIO PL</td> <td>1</td> <td>PZ</td> </tr> <tr> <td>VL1065A1</td> <td>PRESSOSTAT O.N.O. 1/4 M CI</td> <td>1</td> <td>PZ</td> </tr> <tr> <td>VL1067A0</td> <td>DISTRIBUTOR E INGRESSI CIRCUITO LAVAGGIO</td> <td>1</td> <td>PZ</td> </tr> <tr> <td>VL1080A0</td> <td>FILTRO IN LINEA DETERGENTE</td> <td>1</td> <td>PZ</td> </tr> </tbody> </table>	Codice	Descrizione	Qtà	UM	0H7323A0	LAMIERA SUPPORTO LAVAGGIO PLUS	1	PZ	EL1252A1	ELETTROVALV OLA 1 VIA RID.VERDE JG D8-D10	1	PZ	EL1424A0	ELETTROVALV OLA H2O JG D8-PORTAGO MMA D6	1	PZ	EL1436A0	EV H2O JG D8-PORTAGO MMA D6 CHECK VALVE	1	PZ	GN1526A0	O-RING D.INT6.9 SP1.8	1	PZ	RC1019A0	FASCETTA ELASTICA D10 ZINCATA	11	PZ	RC1130A0	FASCETTA 130X2,6	1	PZ	RC1242A0	TERMINALE CHIUSO D10	2	PZ	RC1310A0	FASCETTA RICHCO 140X4 CON CLIP	2	PZ	RC1356A0	RACCORDO DRITTO FIL. FEMM 8X1/4 BSP	1	PZ	TB2820A0	TUBO EPDM 6X10	2.040	M	VI1220A1	VITE AUTOFILETTA NTE 4.2X11 TCS+ MARUTE	2	PZ	VL1019A0	POMPA VIBRAZIONE	1	PZ	VL1064A0	DISTRIBUTOR E USCITE CIRCUITO LAVAGGIO PL	1	PZ	VL1065A1	PRESSOSTAT O.N.O. 1/4 M CI	1	PZ	VL1067A0	DISTRIBUTOR E INGRESSI CIRCUITO LAVAGGIO	1	PZ	VL1080A0	FILTRO IN LINEA DETERGENTE	1	PZ
Codice	Descrizione	Qtà	UM																																																																										
0H7323A0	LAMIERA SUPPORTO LAVAGGIO PLUS	1	PZ																																																																										
EL1252A1	ELETTROVALV OLA 1 VIA RID.VERDE JG D8-D10	1	PZ																																																																										
EL1424A0	ELETTROVALV OLA H2O JG D8-PORTAGO MMA D6	1	PZ																																																																										
EL1436A0	EV H2O JG D8-PORTAGO MMA D6 CHECK VALVE	1	PZ																																																																										
GN1526A0	O-RING D.INT6.9 SP1.8	1	PZ																																																																										
RC1019A0	FASCETTA ELASTICA D10 ZINCATA	11	PZ																																																																										
RC1130A0	FASCETTA 130X2,6	1	PZ																																																																										
RC1242A0	TERMINALE CHIUSO D10	2	PZ																																																																										
RC1310A0	FASCETTA RICHCO 140X4 CON CLIP	2	PZ																																																																										
RC1356A0	RACCORDO DRITTO FIL. FEMM 8X1/4 BSP	1	PZ																																																																										
TB2820A0	TUBO EPDM 6X10	2.040	M																																																																										
VI1220A1	VITE AUTOFILETTA NTE 4.2X11 TCS+ MARUTE	2	PZ																																																																										
VL1019A0	POMPA VIBRAZIONE	1	PZ																																																																										
VL1064A0	DISTRIBUTOR E USCITE CIRCUITO LAVAGGIO PL	1	PZ																																																																										
VL1065A1	PRESSOSTAT O.N.O. 1/4 M CI	1	PZ																																																																										
VL1067A0	DISTRIBUTOR E INGRESSI CIRCUITO LAVAGGIO	1	PZ																																																																										
VL1080A0	FILTRO IN LINEA DETERGENTE	1	PZ																																																																										

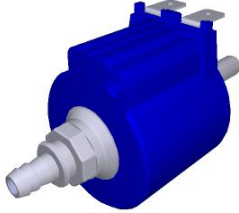
COMPONENTE			RICAMBIO																																																		
Codice	Descrizione	Immagine	Codice	Descrizione	Lista componenti																																																
VL1019A	POMPA VIBRAZIONE		KVL1107A	KIT IMPIANTO LAVAGGIO PLUS 04EU 1 GIR EU	<table border="1"> <thead> <tr> <th>Codice</th> <th>Descrizione</th> <th>Qtà</th> <th>UM</th> </tr> </thead> <tbody> <tr> <td>VL1081A0</td> <td>VALVOLA NON RITORNO BARBED D6</td> <td>2</td> <td>PZ</td> </tr> <tr> <td>VL1083A0</td> <td>RACCORDO D10 - PORTAGOMM A BARBED D6</td> <td>1</td> <td>PZ</td> </tr> <tr> <td>VL1102A0</td> <td>FILTRO IN LINEA CON VNR BARBED 6 MM</td> <td>1</td> <td>PZ</td> </tr> <tr> <td>VL1102A1</td> <td>FILTRO IN LINEA DET. + VNR BARBED 6 MM</td> <td>1</td> <td>PZ</td> </tr> <tr> <td>VL1128A0</td> <td>VALVOLA VNR BARBED D6</td> <td>1</td> <td>PZ</td> </tr> <tr> <td>VM2172A0</td> <td>CLIP BLOCCAGGIO POMPA CON CIRCUITO</td> <td>1</td> <td>PZ</td> </tr> </tbody> </table>	Codice	Descrizione	Qtà	UM	VL1081A0	VALVOLA NON RITORNO BARBED D6	2	PZ	VL1083A0	RACCORDO D10 - PORTAGOMM A BARBED D6	1	PZ	VL1102A0	FILTRO IN LINEA CON VNR BARBED 6 MM	1	PZ	VL1102A1	FILTRO IN LINEA DET. + VNR BARBED 6 MM	1	PZ	VL1128A0	VALVOLA VNR BARBED D6	1	PZ	VM2172A0	CLIP BLOCCAGGIO POMPA CON CIRCUITO	1	PZ																				
Codice	Descrizione	Qtà	UM																																																		
VL1081A0	VALVOLA NON RITORNO BARBED D6	2	PZ																																																		
VL1083A0	RACCORDO D10 - PORTAGOMM A BARBED D6	1	PZ																																																		
VL1102A0	FILTRO IN LINEA CON VNR BARBED 6 MM	1	PZ																																																		
VL1102A1	FILTRO IN LINEA DET. + VNR BARBED 6 MM	1	PZ																																																		
VL1128A0	VALVOLA VNR BARBED D6	1	PZ																																																		
VM2172A0	CLIP BLOCCAGGIO POMPA CON CIRCUITO	1	PZ																																																		
			KVL1106A	KIT IMPIANTO LAVAGGIO ONE 1 GIRANTE EUR	<table border="1"> <thead> <tr> <th>Codice</th> <th>Descrizione</th> <th>Qtà</th> <th>UM</th> </tr> </thead> <tbody> <tr> <td>0H7324A0</td> <td>LAMIERA SUPPORTO LAVAGGIO ON</td> <td>1</td> <td>PZ</td> </tr> <tr> <td>0H7819A0</td> <td>SUPPORTO LAVAGGIO ONE CON ELV STEAM</td> <td>1</td> <td>PZ</td> </tr> <tr> <td>EL1436A0</td> <td>EV H2O JG D8-PORTAGO MMA D6 CHECK VALVE</td> <td>1</td> <td>PZ</td> </tr> <tr> <td>GN1526A0</td> <td>O-RING D.INT6.9 SP1.8</td> <td>1</td> <td>PZ</td> </tr> <tr> <td>RC1006A0</td> <td>CURVA GUIDA TUBO PET D8</td> <td>2</td> <td>PZ</td> </tr> <tr> <td>RC1019A0</td> <td>FASCETTA ELASTICA D10 ZINCATA</td> <td>15</td> <td>PZ</td> </tr> <tr> <td>RC1242A0</td> <td>TERMINALE CHIUSO D10</td> <td>2</td> <td>PZ</td> </tr> <tr> <td>RC1408A0</td> <td>FASCETTA BIFILARE A MOLLA D10.8 TUBO ZN</td> <td>2</td> <td>PZ</td> </tr> <tr> <td>TB1818A0</td> <td>TUBO 8X4.75 PE BLU</td> <td>0.320</td> <td>M</td> </tr> <tr> <td>TB2820A0</td> <td>TUBO EPDM 6X10</td> <td>1.380</td> <td>M</td> </tr> <tr> <td>VI1220A1</td> <td>VITE AUTOFILETTA NTE 4.2X11 TCS+ MARUTE</td> <td>1</td> <td>PZ</td> </tr> </tbody> </table>	Codice	Descrizione	Qtà	UM	0H7324A0	LAMIERA SUPPORTO LAVAGGIO ON	1	PZ	0H7819A0	SUPPORTO LAVAGGIO ONE CON ELV STEAM	1	PZ	EL1436A0	EV H2O JG D8-PORTAGO MMA D6 CHECK VALVE	1	PZ	GN1526A0	O-RING D.INT6.9 SP1.8	1	PZ	RC1006A0	CURVA GUIDA TUBO PET D8	2	PZ	RC1019A0	FASCETTA ELASTICA D10 ZINCATA	15	PZ	RC1242A0	TERMINALE CHIUSO D10	2	PZ	RC1408A0	FASCETTA BIFILARE A MOLLA D10.8 TUBO ZN	2	PZ	TB1818A0	TUBO 8X4.75 PE BLU	0.320	M	TB2820A0	TUBO EPDM 6X10	1.380	M	VI1220A1	VITE AUTOFILETTA NTE 4.2X11 TCS+ MARUTE	1	PZ
Codice	Descrizione	Qtà	UM																																																		
0H7324A0	LAMIERA SUPPORTO LAVAGGIO ON	1	PZ																																																		
0H7819A0	SUPPORTO LAVAGGIO ONE CON ELV STEAM	1	PZ																																																		
EL1436A0	EV H2O JG D8-PORTAGO MMA D6 CHECK VALVE	1	PZ																																																		
GN1526A0	O-RING D.INT6.9 SP1.8	1	PZ																																																		
RC1006A0	CURVA GUIDA TUBO PET D8	2	PZ																																																		
RC1019A0	FASCETTA ELASTICA D10 ZINCATA	15	PZ																																																		
RC1242A0	TERMINALE CHIUSO D10	2	PZ																																																		
RC1408A0	FASCETTA BIFILARE A MOLLA D10.8 TUBO ZN	2	PZ																																																		
TB1818A0	TUBO 8X4.75 PE BLU	0.320	M																																																		
TB2820A0	TUBO EPDM 6X10	1.380	M																																																		
VI1220A1	VITE AUTOFILETTA NTE 4.2X11 TCS+ MARUTE	1	PZ																																																		

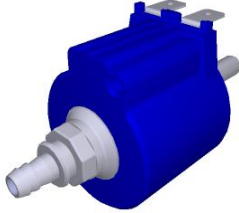
COMPONENTE			RICAMBIO																																										
Codice	Descrizione	Immagine	Codice	Descrizione	Lista componenti																																								
VL1019A	POMPA VIBRAZIONE		KVL1106A	KIT IMPIANTO LAVAGGIO ONE 1 GIRANTE EUR	<table border="1"> <thead> <tr> <th>Codice</th> <th>Descrizione</th> <th>Qtà</th> <th>UM</th> </tr> </thead> <tbody> <tr> <td>VL1019A0</td> <td>POMPA VIBRAZIONE</td> <td>1</td> <td>PZ</td> </tr> <tr> <td>VL1053B0</td> <td>DISTRIBUTORE USCITA LAVAGGIO ON</td> <td>1</td> <td>PZ</td> </tr> <tr> <td>VL1054B0</td> <td>DISTRIBUTORE INGRESSI LAVAGGIO ON</td> <td>1</td> <td>PZ</td> </tr> <tr> <td>VL1080A0</td> <td>FILTRO LINEA DETERGENTE</td> <td>1</td> <td>PZ</td> </tr> <tr> <td>VL1081A0</td> <td>VALVOLA RITORNO BARBED D6</td> <td>1</td> <td>PZ</td> </tr> <tr> <td>VL1102A0</td> <td>FILTRO LINEA CON VNR BARBED 6 MM</td> <td>1</td> <td>PZ</td> </tr> <tr> <td>VL1102A1</td> <td>FILTRO LINEA DET. + VNR BARBED 6 MM</td> <td>1</td> <td>PZ</td> </tr> <tr> <td>VL1128A0</td> <td>VALVOLA VNR BARBED D6</td> <td>1</td> <td>PZ</td> </tr> <tr> <td>VM2172A0</td> <td>CLIP BLOCCAGGIO POMPA CON CIRCUITO</td> <td>1</td> <td>PZ</td> </tr> </tbody> </table>	Codice	Descrizione	Qtà	UM	VL1019A0	POMPA VIBRAZIONE	1	PZ	VL1053B0	DISTRIBUTORE USCITA LAVAGGIO ON	1	PZ	VL1054B0	DISTRIBUTORE INGRESSI LAVAGGIO ON	1	PZ	VL1080A0	FILTRO LINEA DETERGENTE	1	PZ	VL1081A0	VALVOLA RITORNO BARBED D6	1	PZ	VL1102A0	FILTRO LINEA CON VNR BARBED 6 MM	1	PZ	VL1102A1	FILTRO LINEA DET. + VNR BARBED 6 MM	1	PZ	VL1128A0	VALVOLA VNR BARBED D6	1	PZ	VM2172A0	CLIP BLOCCAGGIO POMPA CON CIRCUITO	1	PZ
Codice	Descrizione	Qtà	UM																																										
VL1019A0	POMPA VIBRAZIONE	1	PZ																																										
VL1053B0	DISTRIBUTORE USCITA LAVAGGIO ON	1	PZ																																										
VL1054B0	DISTRIBUTORE INGRESSI LAVAGGIO ON	1	PZ																																										
VL1080A0	FILTRO LINEA DETERGENTE	1	PZ																																										
VL1081A0	VALVOLA RITORNO BARBED D6	1	PZ																																										
VL1102A0	FILTRO LINEA CON VNR BARBED 6 MM	1	PZ																																										
VL1102A1	FILTRO LINEA DET. + VNR BARBED 6 MM	1	PZ																																										
VL1128A0	VALVOLA VNR BARBED D6	1	PZ																																										
VM2172A0	CLIP BLOCCAGGIO POMPA CON CIRCUITO	1	PZ																																										
			KVL1105A	KIT IMPIANTO LAVAGGIO PLUS 2 GIRANTI USA	<table border="1"> <thead> <tr> <th>Codice</th> <th>Descrizione</th> <th>Qtà</th> <th>UM</th> </tr> </thead> <tbody> <tr> <td>0H7323A0</td> <td>LAMIERA SUPPORTO LAVAGGIO PLUS</td> <td>1</td> <td>PZ</td> </tr> <tr> <td>0H7820A0</td> <td>SUPPORTO LAVAGGIO PLUS CON ELV STEAM</td> <td>1</td> <td>PZ</td> </tr> <tr> <td>EL1020A1</td> <td>RACCORDO INTERMEDIO "T" TUBO D8 J</td> <td>1</td> <td>PZ</td> </tr> <tr> <td>EL1422A0</td> <td>ELETTROVALVOLA 1 VIA RID.VERDE JG D8-D10 UL</td> <td>1</td> <td>PZ</td> </tr> <tr> <td>EL1422A1</td> <td>ELETTROVALVOLA 1 VIA RID.VERDE JG D8-D10 UL</td> <td>1</td> <td>PZ</td> </tr> <tr> <td>EL1426A0</td> <td>ELETTROVALVOLA 2 VIE OLA UL H2O JG D8-PORTAGO MMA D</td> <td>2</td> <td>PZ</td> </tr> </tbody> </table>	Codice	Descrizione	Qtà	UM	0H7323A0	LAMIERA SUPPORTO LAVAGGIO PLUS	1	PZ	0H7820A0	SUPPORTO LAVAGGIO PLUS CON ELV STEAM	1	PZ	EL1020A1	RACCORDO INTERMEDIO "T" TUBO D8 J	1	PZ	EL1422A0	ELETTROVALVOLA 1 VIA RID.VERDE JG D8-D10 UL	1	PZ	EL1422A1	ELETTROVALVOLA 1 VIA RID.VERDE JG D8-D10 UL	1	PZ	EL1426A0	ELETTROVALVOLA 2 VIE OLA UL H2O JG D8-PORTAGO MMA D	2	PZ												
Codice	Descrizione	Qtà	UM																																										
0H7323A0	LAMIERA SUPPORTO LAVAGGIO PLUS	1	PZ																																										
0H7820A0	SUPPORTO LAVAGGIO PLUS CON ELV STEAM	1	PZ																																										
EL1020A1	RACCORDO INTERMEDIO "T" TUBO D8 J	1	PZ																																										
EL1422A0	ELETTROVALVOLA 1 VIA RID.VERDE JG D8-D10 UL	1	PZ																																										
EL1422A1	ELETTROVALVOLA 1 VIA RID.VERDE JG D8-D10 UL	1	PZ																																										
EL1426A0	ELETTROVALVOLA 2 VIE OLA UL H2O JG D8-PORTAGO MMA D	2	PZ																																										

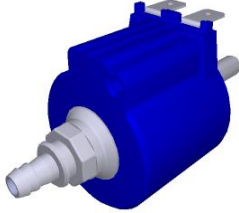
COMPONENTE			RICAMBIO																																																																														
Codice	Descrizione	Immagine	Codice	Descrizione	Lista componenti																																																																												
VL1019A	POMPA VIBRAZIONE		KVL1105A	KIT IMPIANTO LAVAGGIO PLUS 2 GIRANTI USA	<table border="1"> <thead> <tr> <th>Codice</th> <th>Descrizione</th> <th>Qtà</th> <th>UM</th> </tr> </thead> <tbody> <tr> <td>EL1437A0</td> <td>EV H2O JG D8-PORTAGO MMA D6 CH. VALVE UL</td> <td>1</td> <td>PZ</td> </tr> <tr> <td>GN1526A0</td> <td>O-RING D.INT6.9 SP1.8</td> <td>1</td> <td>PZ</td> </tr> <tr> <td>RC1019A0</td> <td>FASCETTA ELASTICA D10 ZINCATA</td> <td>12</td> <td>PZ</td> </tr> <tr> <td>RC1130A0</td> <td>FASCETTA 130X2,6</td> <td>1</td> <td>PZ</td> </tr> <tr> <td>RC1242A0</td> <td>TERMINALE CHIUSO D10</td> <td>2</td> <td>PZ</td> </tr> <tr> <td>RC1310A0</td> <td>FASCETTA RICHCO 140X4 CON CLIP</td> <td>2</td> <td>PZ</td> </tr> <tr> <td>RC1356A0</td> <td>RACCORDO DRITTO FIL. FEMM 8X1/4 BSP</td> <td>1</td> <td>PZ</td> </tr> <tr> <td>RC1408A0</td> <td>FASCETTA BIFILARE A MOLLA D10.8 TUBO ZN</td> <td>2</td> <td>PZ</td> </tr> <tr> <td>TB1818A0</td> <td>TUBO 8X4.75 PE BLU</td> <td>0.300</td> <td>M</td> </tr> <tr> <td>TB2820A0</td> <td>TUBO EPDM 6X10</td> <td>2.040</td> <td>M</td> </tr> <tr> <td>VI1220A1</td> <td>VITE AUTOFILETTA NTE 4.2X11 TCS+ MARUTE</td> <td>2</td> <td>PZ</td> </tr> <tr> <td>VL1019A0</td> <td>POMPA VIBRAZIONE</td> <td>1</td> <td>PZ</td> </tr> <tr> <td>VL1065A1</td> <td>PRESSOSTAT O.N.O. 1/4 M CI</td> <td>1</td> <td>PZ</td> </tr> <tr> <td>VL1067A0</td> <td>DISTRIBUTOR E INGRESSI CIRCUITO LAVAGGIO</td> <td>1</td> <td>PZ</td> </tr> <tr> <td>VL1080A0</td> <td>FILTRO IN LINEA DETERGENTE</td> <td>1</td> <td>PZ</td> </tr> <tr> <td>VL1081A0</td> <td>VALVOLA NON RITORNO BARBED D6</td> <td>2</td> <td>PZ</td> </tr> <tr> <td>VL1083A0</td> <td>RACCORDO D10 - PORTAGOMM A BARBED D6</td> <td>1</td> <td>PZ</td> </tr> <tr> <td>VL1092A0</td> <td>DISTRIBUTOR E USCITE LAVAGGIO PLUS DOPPIA</td> <td>1</td> <td>PZ</td> </tr> </tbody> </table>	Codice	Descrizione	Qtà	UM	EL1437A0	EV H2O JG D8-PORTAGO MMA D6 CH. VALVE UL	1	PZ	GN1526A0	O-RING D.INT6.9 SP1.8	1	PZ	RC1019A0	FASCETTA ELASTICA D10 ZINCATA	12	PZ	RC1130A0	FASCETTA 130X2,6	1	PZ	RC1242A0	TERMINALE CHIUSO D10	2	PZ	RC1310A0	FASCETTA RICHCO 140X4 CON CLIP	2	PZ	RC1356A0	RACCORDO DRITTO FIL. FEMM 8X1/4 BSP	1	PZ	RC1408A0	FASCETTA BIFILARE A MOLLA D10.8 TUBO ZN	2	PZ	TB1818A0	TUBO 8X4.75 PE BLU	0.300	M	TB2820A0	TUBO EPDM 6X10	2.040	M	VI1220A1	VITE AUTOFILETTA NTE 4.2X11 TCS+ MARUTE	2	PZ	VL1019A0	POMPA VIBRAZIONE	1	PZ	VL1065A1	PRESSOSTAT O.N.O. 1/4 M CI	1	PZ	VL1067A0	DISTRIBUTOR E INGRESSI CIRCUITO LAVAGGIO	1	PZ	VL1080A0	FILTRO IN LINEA DETERGENTE	1	PZ	VL1081A0	VALVOLA NON RITORNO BARBED D6	2	PZ	VL1083A0	RACCORDO D10 - PORTAGOMM A BARBED D6	1	PZ	VL1092A0	DISTRIBUTOR E USCITE LAVAGGIO PLUS DOPPIA	1	PZ
Codice	Descrizione	Qtà	UM																																																																														
EL1437A0	EV H2O JG D8-PORTAGO MMA D6 CH. VALVE UL	1	PZ																																																																														
GN1526A0	O-RING D.INT6.9 SP1.8	1	PZ																																																																														
RC1019A0	FASCETTA ELASTICA D10 ZINCATA	12	PZ																																																																														
RC1130A0	FASCETTA 130X2,6	1	PZ																																																																														
RC1242A0	TERMINALE CHIUSO D10	2	PZ																																																																														
RC1310A0	FASCETTA RICHCO 140X4 CON CLIP	2	PZ																																																																														
RC1356A0	RACCORDO DRITTO FIL. FEMM 8X1/4 BSP	1	PZ																																																																														
RC1408A0	FASCETTA BIFILARE A MOLLA D10.8 TUBO ZN	2	PZ																																																																														
TB1818A0	TUBO 8X4.75 PE BLU	0.300	M																																																																														
TB2820A0	TUBO EPDM 6X10	2.040	M																																																																														
VI1220A1	VITE AUTOFILETTA NTE 4.2X11 TCS+ MARUTE	2	PZ																																																																														
VL1019A0	POMPA VIBRAZIONE	1	PZ																																																																														
VL1065A1	PRESSOSTAT O.N.O. 1/4 M CI	1	PZ																																																																														
VL1067A0	DISTRIBUTOR E INGRESSI CIRCUITO LAVAGGIO	1	PZ																																																																														
VL1080A0	FILTRO IN LINEA DETERGENTE	1	PZ																																																																														
VL1081A0	VALVOLA NON RITORNO BARBED D6	2	PZ																																																																														
VL1083A0	RACCORDO D10 - PORTAGOMM A BARBED D6	1	PZ																																																																														
VL1092A0	DISTRIBUTOR E USCITE LAVAGGIO PLUS DOPPIA	1	PZ																																																																														

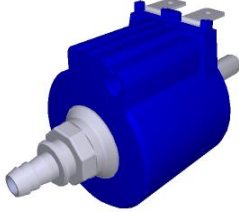
COMPONENTE			RICAMBIO																																																			
Codice	Descrizione	Immagine	Codice	Descrizione	Lista componenti																																																	
VL1019A	POMPA VIBRAZIONE		KVL1105A	KIT IMPIANTO LAVAGGIO PLUS 2 GIRANTI USA	<table border="1"> <thead> <tr> <th>Codice</th> <th>Descrizione</th> <th>Qtà</th> <th>UM</th> </tr> </thead> <tbody> <tr> <td>VL1102A0</td> <td>FILTRO IN LINEA CON VNR BARBED 6 MM</td> <td>1</td> <td>PZ</td> </tr> <tr> <td>VL1102A1</td> <td>FILTRO IN LINEA DET. + VNR BARBED 6 MM</td> <td>1</td> <td>PZ</td> </tr> <tr> <td>VL1128A0</td> <td>VALVOLA VNR BARBED D6</td> <td>1</td> <td>PZ</td> </tr> <tr> <td>VM2172A0</td> <td>CLIP BLOCCAGGIO POMPA CON CIRCUITO</td> <td>1</td> <td>PZ</td> </tr> </tbody> </table>	Codice	Descrizione	Qtà	UM	VL1102A0	FILTRO IN LINEA CON VNR BARBED 6 MM	1	PZ	VL1102A1	FILTRO IN LINEA DET. + VNR BARBED 6 MM	1	PZ	VL1128A0	VALVOLA VNR BARBED D6	1	PZ	VM2172A0	CLIP BLOCCAGGIO POMPA CON CIRCUITO	1	PZ																													
			Codice	Descrizione	Qtà	UM																																																
VL1102A0	FILTRO IN LINEA CON VNR BARBED 6 MM	1	PZ																																																			
VL1102A1	FILTRO IN LINEA DET. + VNR BARBED 6 MM	1	PZ																																																			
VL1128A0	VALVOLA VNR BARBED D6	1	PZ																																																			
VM2172A0	CLIP BLOCCAGGIO POMPA CON CIRCUITO	1	PZ																																																			
KVL1104A	KIT IMPIANTO LAVAGGIO PLUS 1 GIRANTE USA	<table border="1"> <thead> <tr> <th>Codice</th> <th>Descrizione</th> <th>Qtà</th> <th>UM</th> </tr> </thead> <tbody> <tr> <td>0H7323A0</td> <td>LAMIERA SUPPORTO LAVAGGIO PLUS</td> <td>1</td> <td>PZ</td> </tr> <tr> <td>0H7820A0</td> <td>SUPPORTO LAVAGGIO PLUS CON ELV STEAM</td> <td>1</td> <td>PZ</td> </tr> <tr> <td>EL1020A1</td> <td>RACCORDO INTERMEDIO "T" TUBO D8-J</td> <td>1</td> <td>PZ</td> </tr> <tr> <td>EL1422A0</td> <td>ELETTROVALV 1 VIA RID.VERDE JG D8-D10 UL</td> <td>1</td> <td>PZ</td> </tr> <tr> <td>EL1422A1</td> <td>ELETTROVALV 1 VIA RID.VERDE JG D8-D10 UL</td> <td>1</td> <td>PZ</td> </tr> <tr> <td>EL1426A0</td> <td>ELETTROVALV OLA UL H2O JG D8-PORTAGO MMA D</td> <td>1</td> <td>PZ</td> </tr> <tr> <td>EL1437A0</td> <td>EV H2O JG D8-PORTAGO MMA D6 CH. VALVE UL</td> <td>1</td> <td>PZ</td> </tr> <tr> <td>GN1526A0</td> <td>O-RING D.INT6.9 SP1.8</td> <td>1</td> <td>PZ</td> </tr> <tr> <td>RC1019A0</td> <td>FASCETTA ELASTICA D10 ZINCATA</td> <td>11</td> <td>PZ</td> </tr> <tr> <td>RC1130A0</td> <td>FASCETTA 130X2,6</td> <td>1</td> <td>PZ</td> </tr> <tr> <td>RC1242A0</td> <td>TERMINALE CHIUSO D10</td> <td>2</td> <td>PZ</td> </tr> <tr> <td>RC1310A0</td> <td>FASCETTA RICHCO 140X4 CON CLIP</td> <td>2</td> <td>PZ</td> </tr> </tbody> </table>	Codice	Descrizione	Qtà	UM	0H7323A0	LAMIERA SUPPORTO LAVAGGIO PLUS	1	PZ	0H7820A0	SUPPORTO LAVAGGIO PLUS CON ELV STEAM	1	PZ	EL1020A1	RACCORDO INTERMEDIO "T" TUBO D8-J	1	PZ	EL1422A0	ELETTROVALV 1 VIA RID.VERDE JG D8-D10 UL	1	PZ	EL1422A1	ELETTROVALV 1 VIA RID.VERDE JG D8-D10 UL	1	PZ	EL1426A0	ELETTROVALV OLA UL H2O JG D8-PORTAGO MMA D	1	PZ	EL1437A0	EV H2O JG D8-PORTAGO MMA D6 CH. VALVE UL	1	PZ	GN1526A0	O-RING D.INT6.9 SP1.8	1	PZ	RC1019A0	FASCETTA ELASTICA D10 ZINCATA	11	PZ	RC1130A0	FASCETTA 130X2,6	1	PZ	RC1242A0	TERMINALE CHIUSO D10	2	PZ	RC1310A0	FASCETTA RICHCO 140X4 CON CLIP	2	PZ
Codice	Descrizione	Qtà	UM																																																			
0H7323A0	LAMIERA SUPPORTO LAVAGGIO PLUS	1	PZ																																																			
0H7820A0	SUPPORTO LAVAGGIO PLUS CON ELV STEAM	1	PZ																																																			
EL1020A1	RACCORDO INTERMEDIO "T" TUBO D8-J	1	PZ																																																			
EL1422A0	ELETTROVALV 1 VIA RID.VERDE JG D8-D10 UL	1	PZ																																																			
EL1422A1	ELETTROVALV 1 VIA RID.VERDE JG D8-D10 UL	1	PZ																																																			
EL1426A0	ELETTROVALV OLA UL H2O JG D8-PORTAGO MMA D	1	PZ																																																			
EL1437A0	EV H2O JG D8-PORTAGO MMA D6 CH. VALVE UL	1	PZ																																																			
GN1526A0	O-RING D.INT6.9 SP1.8	1	PZ																																																			
RC1019A0	FASCETTA ELASTICA D10 ZINCATA	11	PZ																																																			
RC1130A0	FASCETTA 130X2,6	1	PZ																																																			
RC1242A0	TERMINALE CHIUSO D10	2	PZ																																																			
RC1310A0	FASCETTA RICHCO 140X4 CON CLIP	2	PZ																																																			

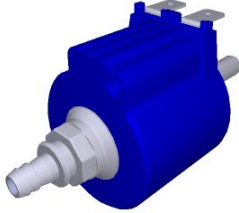

COMPONENTE			RICAMBIO																																																																						
Codice	Descrizione	Immagine	Codice	Descrizione	Lista componenti																																																																				
VL1019A	POMPA VIBRAZIONE		KVL1104A	KIT IMPIANTO LAVAGGIO PLUS 1 GIRANTE USA	<table border="1"> <thead> <tr> <th>Codice</th> <th>Descrizione</th> <th>Qtà</th> <th>UM</th> </tr> </thead> <tbody> <tr> <td>RC1356A0</td> <td>RACCORDO DRITTO FIL. FEMM 8X1/4 BSP</td> <td>1</td> <td>PZ</td> </tr> <tr> <td>RC1408A0</td> <td>FASCETTA BIFILARE A MOLLA D10.8 TUBO ZN</td> <td>2</td> <td>PZ</td> </tr> <tr> <td>TB1818A0</td> <td>TUBO 8X4.75 PE BLU</td> <td>0.300</td> <td>M</td> </tr> <tr> <td>TB2820A0</td> <td>TUBO EPDM 6X10</td> <td>1.240</td> <td>M</td> </tr> <tr> <td>VI1220A1</td> <td>VITE AUTOFILETTA NTE 4.2X11 TCS+ MARUTE</td> <td>2</td> <td>PZ</td> </tr> <tr> <td>VL1019A0</td> <td>POMPA VIBRAZIONE</td> <td>1</td> <td>PZ</td> </tr> <tr> <td>VL1064A0</td> <td>DISTRIBUTOR E USCITE CIRCUITO LAVAGGIO PL</td> <td>1</td> <td>PZ</td> </tr> <tr> <td>VL1065A1</td> <td>PRESSOSTAT O.N.O. 1/4 M.CI</td> <td>1</td> <td>PZ</td> </tr> <tr> <td>VL1067A0</td> <td>DISTRIBUTOR E INGRESSI CIRCUITO LAVAGGIO</td> <td>1</td> <td>PZ</td> </tr> <tr> <td>VL1080A0</td> <td>FILTRO IN LINEA DETERGENTE</td> <td>1</td> <td>PZ</td> </tr> <tr> <td>VL1081A0</td> <td>VALVOLA NON RITORNO BARBED D6</td> <td>2</td> <td>PZ</td> </tr> <tr> <td>VL1083A0</td> <td>RACCORDO D10 - PORTAGOMM A BARBED D6</td> <td>1</td> <td>PZ</td> </tr> <tr> <td>VL1102A0</td> <td>FILTRO IN LINEA CON VNR BARBED 6 MM</td> <td>1</td> <td>PZ</td> </tr> <tr> <td>VL1102A1</td> <td>FILTRO IN LINEA DET. + VNR BARBED 6 MM</td> <td>1</td> <td>PZ</td> </tr> <tr> <td>VL1128A0</td> <td>VALVOLA VNR BARBED D6</td> <td>1</td> <td>PZ</td> </tr> <tr> <td>VM2172A0</td> <td>CLIP BLOCCAGGIO POMPA CON CIRCUITO</td> <td>1</td> <td>PZ</td> </tr> </tbody> </table>	Codice	Descrizione	Qtà	UM	RC1356A0	RACCORDO DRITTO FIL. FEMM 8X1/4 BSP	1	PZ	RC1408A0	FASCETTA BIFILARE A MOLLA D10.8 TUBO ZN	2	PZ	TB1818A0	TUBO 8X4.75 PE BLU	0.300	M	TB2820A0	TUBO EPDM 6X10	1.240	M	VI1220A1	VITE AUTOFILETTA NTE 4.2X11 TCS+ MARUTE	2	PZ	VL1019A0	POMPA VIBRAZIONE	1	PZ	VL1064A0	DISTRIBUTOR E USCITE CIRCUITO LAVAGGIO PL	1	PZ	VL1065A1	PRESSOSTAT O.N.O. 1/4 M.CI	1	PZ	VL1067A0	DISTRIBUTOR E INGRESSI CIRCUITO LAVAGGIO	1	PZ	VL1080A0	FILTRO IN LINEA DETERGENTE	1	PZ	VL1081A0	VALVOLA NON RITORNO BARBED D6	2	PZ	VL1083A0	RACCORDO D10 - PORTAGOMM A BARBED D6	1	PZ	VL1102A0	FILTRO IN LINEA CON VNR BARBED 6 MM	1	PZ	VL1102A1	FILTRO IN LINEA DET. + VNR BARBED 6 MM	1	PZ	VL1128A0	VALVOLA VNR BARBED D6	1	PZ	VM2172A0	CLIP BLOCCAGGIO POMPA CON CIRCUITO	1	PZ
Codice	Descrizione	Qtà	UM																																																																						
RC1356A0	RACCORDO DRITTO FIL. FEMM 8X1/4 BSP	1	PZ																																																																						
RC1408A0	FASCETTA BIFILARE A MOLLA D10.8 TUBO ZN	2	PZ																																																																						
TB1818A0	TUBO 8X4.75 PE BLU	0.300	M																																																																						
TB2820A0	TUBO EPDM 6X10	1.240	M																																																																						
VI1220A1	VITE AUTOFILETTA NTE 4.2X11 TCS+ MARUTE	2	PZ																																																																						
VL1019A0	POMPA VIBRAZIONE	1	PZ																																																																						
VL1064A0	DISTRIBUTOR E USCITE CIRCUITO LAVAGGIO PL	1	PZ																																																																						
VL1065A1	PRESSOSTAT O.N.O. 1/4 M.CI	1	PZ																																																																						
VL1067A0	DISTRIBUTOR E INGRESSI CIRCUITO LAVAGGIO	1	PZ																																																																						
VL1080A0	FILTRO IN LINEA DETERGENTE	1	PZ																																																																						
VL1081A0	VALVOLA NON RITORNO BARBED D6	2	PZ																																																																						
VL1083A0	RACCORDO D10 - PORTAGOMM A BARBED D6	1	PZ																																																																						
VL1102A0	FILTRO IN LINEA CON VNR BARBED 6 MM	1	PZ																																																																						
VL1102A1	FILTRO IN LINEA DET. + VNR BARBED 6 MM	1	PZ																																																																						
VL1128A0	VALVOLA VNR BARBED D6	1	PZ																																																																						
VM2172A0	CLIP BLOCCAGGIO POMPA CON CIRCUITO	1	PZ																																																																						

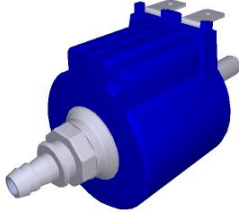
COMPONENTE			RICAMBIO																																																																										
Codice	Descrizione	Immagine	Codice	Descrizione	Lista componenti																																																																								
VL1019A	POMPA VIBRAZIONE		KVL1103A	KIT IMPIANTO LAVAGGIO PLUS 2 GIRANTI EUR	<table border="1"> <thead> <tr> <th>Codice</th> <th>Descrizione</th> <th>Qtà</th> <th>UM</th> </tr> </thead> <tbody> <tr> <td>0H7323A0</td> <td>LAMIERA SUPPORTO LAVAGGIO PLUS</td> <td>1</td> <td>PZ</td> </tr> <tr> <td>0H7820A0</td> <td>SUPPORTO LAVAGGIO PLUS CON ELV STEAM</td> <td>1</td> <td>PZ</td> </tr> <tr> <td>EL1252A1</td> <td>ELETTROVALV OLA 1 VIA RID.VERDE JG D8-D10</td> <td>1</td> <td>PZ</td> </tr> <tr> <td>EL1424A0</td> <td>ELETTROVALV OLA H2O JG D8-PORTAGO MMA D6</td> <td>2</td> <td>PZ</td> </tr> <tr> <td>EL1436A0</td> <td>EV H2O JG D8-PORTAGO MMA D6 CHECK VALVE</td> <td>1</td> <td>PZ</td> </tr> <tr> <td>GN1526A0</td> <td>O-RING D.INT6.9 SP1.8</td> <td>1</td> <td>PZ</td> </tr> <tr> <td>RC1019A0</td> <td>FASCETTA ELASTICA D10 ZINCATA</td> <td>12</td> <td>PZ</td> </tr> <tr> <td>RC1130A0</td> <td>FASCETTA 130X2,6</td> <td>1</td> <td>PZ</td> </tr> <tr> <td>RC1242A0</td> <td>TERMINALE CHIUSO D10</td> <td>2</td> <td>PZ</td> </tr> <tr> <td>RC1310A0</td> <td>FASCETTA RICHCO 140X4 CON CLIP</td> <td>2</td> <td>PZ</td> </tr> <tr> <td>RC1356A0</td> <td>RACCORDO DRITTO FIL. FEMM 8X1/4 BSP</td> <td>1</td> <td>PZ</td> </tr> <tr> <td>RC1408A0</td> <td>FASCETTA BIFILARE A MOLLA D10.8 TUBO ZN</td> <td>2</td> <td>PZ</td> </tr> <tr> <td>TB1818A0</td> <td>TUBO 8X4.75 PE BLU</td> <td>0.220</td> <td>M</td> </tr> <tr> <td>TB2820A0</td> <td>TUBO EPDM 6X10</td> <td>2.040</td> <td>M</td> </tr> <tr> <td>VI1220A1</td> <td>VITE AUTOFILETTA NTE 4.2X11 TCS+ MARUTE</td> <td>2</td> <td>PZ</td> </tr> <tr> <td>VL1019A0</td> <td>POMPA VIBRAZIONE</td> <td>1</td> <td>PZ</td> </tr> <tr> <td>VL1065A1</td> <td>PRESSOSTAT O.N.O. 1/4 M CI</td> <td>1</td> <td>PZ</td> </tr> </tbody> </table>	Codice	Descrizione	Qtà	UM	0H7323A0	LAMIERA SUPPORTO LAVAGGIO PLUS	1	PZ	0H7820A0	SUPPORTO LAVAGGIO PLUS CON ELV STEAM	1	PZ	EL1252A1	ELETTROVALV OLA 1 VIA RID.VERDE JG D8-D10	1	PZ	EL1424A0	ELETTROVALV OLA H2O JG D8-PORTAGO MMA D6	2	PZ	EL1436A0	EV H2O JG D8-PORTAGO MMA D6 CHECK VALVE	1	PZ	GN1526A0	O-RING D.INT6.9 SP1.8	1	PZ	RC1019A0	FASCETTA ELASTICA D10 ZINCATA	12	PZ	RC1130A0	FASCETTA 130X2,6	1	PZ	RC1242A0	TERMINALE CHIUSO D10	2	PZ	RC1310A0	FASCETTA RICHCO 140X4 CON CLIP	2	PZ	RC1356A0	RACCORDO DRITTO FIL. FEMM 8X1/4 BSP	1	PZ	RC1408A0	FASCETTA BIFILARE A MOLLA D10.8 TUBO ZN	2	PZ	TB1818A0	TUBO 8X4.75 PE BLU	0.220	M	TB2820A0	TUBO EPDM 6X10	2.040	M	VI1220A1	VITE AUTOFILETTA NTE 4.2X11 TCS+ MARUTE	2	PZ	VL1019A0	POMPA VIBRAZIONE	1	PZ	VL1065A1	PRESSOSTAT O.N.O. 1/4 M CI	1	PZ
Codice	Descrizione	Qtà	UM																																																																										
0H7323A0	LAMIERA SUPPORTO LAVAGGIO PLUS	1	PZ																																																																										
0H7820A0	SUPPORTO LAVAGGIO PLUS CON ELV STEAM	1	PZ																																																																										
EL1252A1	ELETTROVALV OLA 1 VIA RID.VERDE JG D8-D10	1	PZ																																																																										
EL1424A0	ELETTROVALV OLA H2O JG D8-PORTAGO MMA D6	2	PZ																																																																										
EL1436A0	EV H2O JG D8-PORTAGO MMA D6 CHECK VALVE	1	PZ																																																																										
GN1526A0	O-RING D.INT6.9 SP1.8	1	PZ																																																																										
RC1019A0	FASCETTA ELASTICA D10 ZINCATA	12	PZ																																																																										
RC1130A0	FASCETTA 130X2,6	1	PZ																																																																										
RC1242A0	TERMINALE CHIUSO D10	2	PZ																																																																										
RC1310A0	FASCETTA RICHCO 140X4 CON CLIP	2	PZ																																																																										
RC1356A0	RACCORDO DRITTO FIL. FEMM 8X1/4 BSP	1	PZ																																																																										
RC1408A0	FASCETTA BIFILARE A MOLLA D10.8 TUBO ZN	2	PZ																																																																										
TB1818A0	TUBO 8X4.75 PE BLU	0.220	M																																																																										
TB2820A0	TUBO EPDM 6X10	2.040	M																																																																										
VI1220A1	VITE AUTOFILETTA NTE 4.2X11 TCS+ MARUTE	2	PZ																																																																										
VL1019A0	POMPA VIBRAZIONE	1	PZ																																																																										
VL1065A1	PRESSOSTAT O.N.O. 1/4 M CI	1	PZ																																																																										

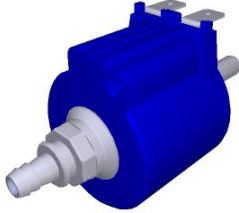
COMPONENTE			RICAMBIO																																										
Codice	Descrizione	Immagine	Codice	Descrizione	Lista componenti																																								
VL1019A	POMPA VIBRAZIONE		KVL1103A	KIT IMPIANTO LAVAGGIO PLUS 2 GIRANTI EUR	<table border="1"> <thead> <tr> <th>Codice</th> <th>Descrizione</th> <th>Qtà</th> <th>UM</th> </tr> </thead> <tbody> <tr> <td>VL1067A0</td> <td>DISTRIBUTOR E INGRESSI CIRCUITO LAVAGGIO</td> <td>1</td> <td>PZ</td> </tr> <tr> <td>VL1080A0</td> <td>FILTRO IN LINEA DETERGENTE</td> <td>1</td> <td>PZ</td> </tr> <tr> <td>VL1081A0</td> <td>VALVOLA NON RITORNO BARBED D6</td> <td>2</td> <td>PZ</td> </tr> <tr> <td>VL1083A0</td> <td>RACCORDO D10 - PORTAGOMM A BARBED D6</td> <td>1</td> <td>PZ</td> </tr> <tr> <td>VL1092A0</td> <td>DISTRIBUTOR E USCITE LAVAGGIO PLUS DOPPIA</td> <td>1</td> <td>PZ</td> </tr> <tr> <td>VL1102A0</td> <td>FILTRO IN LINEA CON VNR BARBED 6 MM</td> <td>1</td> <td>PZ</td> </tr> <tr> <td>VL1102A1</td> <td>FILTRO IN LINEA DET. + VNR BARBED 6 MM</td> <td>1</td> <td>PZ</td> </tr> <tr> <td>VL1128A0</td> <td>VALVOLA VNR BARBED D6</td> <td>1</td> <td>PZ</td> </tr> <tr> <td>VM2172A0</td> <td>CLIP BLOCCAGGIO POMPA CON CIRCUITO</td> <td>1</td> <td>PZ</td> </tr> </tbody> </table>	Codice	Descrizione	Qtà	UM	VL1067A0	DISTRIBUTOR E INGRESSI CIRCUITO LAVAGGIO	1	PZ	VL1080A0	FILTRO IN LINEA DETERGENTE	1	PZ	VL1081A0	VALVOLA NON RITORNO BARBED D6	2	PZ	VL1083A0	RACCORDO D10 - PORTAGOMM A BARBED D6	1	PZ	VL1092A0	DISTRIBUTOR E USCITE LAVAGGIO PLUS DOPPIA	1	PZ	VL1102A0	FILTRO IN LINEA CON VNR BARBED 6 MM	1	PZ	VL1102A1	FILTRO IN LINEA DET. + VNR BARBED 6 MM	1	PZ	VL1128A0	VALVOLA VNR BARBED D6	1	PZ	VM2172A0	CLIP BLOCCAGGIO POMPA CON CIRCUITO	1	PZ
Codice	Descrizione	Qtà	UM																																										
VL1067A0	DISTRIBUTOR E INGRESSI CIRCUITO LAVAGGIO	1	PZ																																										
VL1080A0	FILTRO IN LINEA DETERGENTE	1	PZ																																										
VL1081A0	VALVOLA NON RITORNO BARBED D6	2	PZ																																										
VL1083A0	RACCORDO D10 - PORTAGOMM A BARBED D6	1	PZ																																										
VL1092A0	DISTRIBUTOR E USCITE LAVAGGIO PLUS DOPPIA	1	PZ																																										
VL1102A0	FILTRO IN LINEA CON VNR BARBED 6 MM	1	PZ																																										
VL1102A1	FILTRO IN LINEA DET. + VNR BARBED 6 MM	1	PZ																																										
VL1128A0	VALVOLA VNR BARBED D6	1	PZ																																										
VM2172A0	CLIP BLOCCAGGIO POMPA CON CIRCUITO	1	PZ																																										
			KVL1101A	KIT IMPIANTO LAVAGGIO PLUS 1 GIRANTE EUR	<table border="1"> <thead> <tr> <th>Codice</th> <th>Descrizione</th> <th>Qtà</th> <th>UM</th> </tr> </thead> <tbody> <tr> <td>0H7323A0</td> <td>LAMIERA SUPPORTO LAVAGGIO PLUS</td> <td>1</td> <td>PZ</td> </tr> <tr> <td>0H7820A0</td> <td>SUPPORTO LAVAGGIO PLUS CON ELV STEAM</td> <td>1</td> <td>PZ</td> </tr> <tr> <td>EL1252A1</td> <td>ELETTROVALV OLA 1 VIA RID.VERDE JG D8-D10</td> <td>1</td> <td>PZ</td> </tr> <tr> <td>EL1424A0</td> <td>ELETTROVALV OLA H2O JG D8-PORTAGO MMA D6</td> <td>1</td> <td>PZ</td> </tr> <tr> <td>EL1436A0</td> <td>EV H2O JG D8-PORTAGO MMA D6 CHECK VALVE</td> <td>1</td> <td>PZ</td> </tr> </tbody> </table>	Codice	Descrizione	Qtà	UM	0H7323A0	LAMIERA SUPPORTO LAVAGGIO PLUS	1	PZ	0H7820A0	SUPPORTO LAVAGGIO PLUS CON ELV STEAM	1	PZ	EL1252A1	ELETTROVALV OLA 1 VIA RID.VERDE JG D8-D10	1	PZ	EL1424A0	ELETTROVALV OLA H2O JG D8-PORTAGO MMA D6	1	PZ	EL1436A0	EV H2O JG D8-PORTAGO MMA D6 CHECK VALVE	1	PZ																
Codice	Descrizione	Qtà	UM																																										
0H7323A0	LAMIERA SUPPORTO LAVAGGIO PLUS	1	PZ																																										
0H7820A0	SUPPORTO LAVAGGIO PLUS CON ELV STEAM	1	PZ																																										
EL1252A1	ELETTROVALV OLA 1 VIA RID.VERDE JG D8-D10	1	PZ																																										
EL1424A0	ELETTROVALV OLA H2O JG D8-PORTAGO MMA D6	1	PZ																																										
EL1436A0	EV H2O JG D8-PORTAGO MMA D6 CHECK VALVE	1	PZ																																										

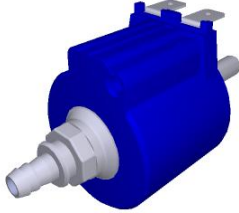
COMPONENTE			RICAMBIO																																																																														
Codice	Descrizione	Immagine	Codice	Descrizione	Lista componenti																																																																												
VL1019A	POMPA VIBRAZIONE		KVL1101A	KIT IMPIANTO LAVAGGIO PLUS 1 GIRANTE EUR	<table border="1"> <thead> <tr> <th>Codice</th> <th>Descrizione</th> <th>Qtà</th> <th>UM</th> </tr> </thead> <tbody> <tr> <td>GN1526A0</td> <td>O-RING D.INT6.9 SP1.8</td> <td>1</td> <td>PZ</td> </tr> <tr> <td>RC1019A0</td> <td>FASCETTA ELASTICA D10 ZINCATA</td> <td>11</td> <td>PZ</td> </tr> <tr> <td>RC1130A0</td> <td>FASCETTA 130X2,6</td> <td>1</td> <td>PZ</td> </tr> <tr> <td>RC1242A0</td> <td>TERMINALE CHIUSO D10</td> <td>2</td> <td>PZ</td> </tr> <tr> <td>RC1310A0</td> <td>FASCETTA RICHCO 140X4 CON CLIP</td> <td>2</td> <td>PZ</td> </tr> <tr> <td>RC1356A0</td> <td>RACCORDO DRITTO FIL. FEMM 8X1/4 BSP</td> <td>1</td> <td>PZ</td> </tr> <tr> <td>RC1408A0</td> <td>FASCETTA BIFILARE A MOLLA D10.8 TUBO ZN</td> <td>6</td> <td>PZ</td> </tr> <tr> <td>TB1818A0</td> <td>TUBO 8X4.75 PE BLU</td> <td>0.220</td> <td>M</td> </tr> <tr> <td>TB2820A0</td> <td>TUBO EPDM 6X10</td> <td>1.240</td> <td>M</td> </tr> <tr> <td>VI1220A1</td> <td>VITE AUTOFILETTA NTE 4.2X11 TCS+ MARUTE</td> <td>2</td> <td>PZ</td> </tr> <tr> <td>VL1019A0</td> <td>POMPA VIBRAZIONE</td> <td>1</td> <td>PZ</td> </tr> <tr> <td>VL1064A0</td> <td>DISTRIBUTOR E USCITE CIRCUITO LAVAGGIO PL</td> <td>1</td> <td>PZ</td> </tr> <tr> <td>VL1065A1</td> <td>PRESSOSTAT O N.O. 1/4 M CI</td> <td>1</td> <td>PZ</td> </tr> <tr> <td>VL1067A0</td> <td>DISTRIBUTOR E INGRESSI CIRCUITO LAVAGGIO</td> <td>1</td> <td>PZ</td> </tr> <tr> <td>VL1080A0</td> <td>FILTRO IN LINEA DETERGENTE</td> <td>1</td> <td>PZ</td> </tr> <tr> <td>VL1081A0</td> <td>VALVOLA NON RITORNO BARBED D6</td> <td>2</td> <td>PZ</td> </tr> <tr> <td>VL1083A0</td> <td>RACCORDO D10 - PORTAGOMM A BARBED D6</td> <td>1</td> <td>PZ</td> </tr> <tr> <td>VL1102A0</td> <td>FILTRO IN LINEA CON VNR BARBED 6 MM</td> <td>1</td> <td>PZ</td> </tr> </tbody> </table>	Codice	Descrizione	Qtà	UM	GN1526A0	O-RING D.INT6.9 SP1.8	1	PZ	RC1019A0	FASCETTA ELASTICA D10 ZINCATA	11	PZ	RC1130A0	FASCETTA 130X2,6	1	PZ	RC1242A0	TERMINALE CHIUSO D10	2	PZ	RC1310A0	FASCETTA RICHCO 140X4 CON CLIP	2	PZ	RC1356A0	RACCORDO DRITTO FIL. FEMM 8X1/4 BSP	1	PZ	RC1408A0	FASCETTA BIFILARE A MOLLA D10.8 TUBO ZN	6	PZ	TB1818A0	TUBO 8X4.75 PE BLU	0.220	M	TB2820A0	TUBO EPDM 6X10	1.240	M	VI1220A1	VITE AUTOFILETTA NTE 4.2X11 TCS+ MARUTE	2	PZ	VL1019A0	POMPA VIBRAZIONE	1	PZ	VL1064A0	DISTRIBUTOR E USCITE CIRCUITO LAVAGGIO PL	1	PZ	VL1065A1	PRESSOSTAT O N.O. 1/4 M CI	1	PZ	VL1067A0	DISTRIBUTOR E INGRESSI CIRCUITO LAVAGGIO	1	PZ	VL1080A0	FILTRO IN LINEA DETERGENTE	1	PZ	VL1081A0	VALVOLA NON RITORNO BARBED D6	2	PZ	VL1083A0	RACCORDO D10 - PORTAGOMM A BARBED D6	1	PZ	VL1102A0	FILTRO IN LINEA CON VNR BARBED 6 MM	1	PZ
Codice	Descrizione	Qtà	UM																																																																														
GN1526A0	O-RING D.INT6.9 SP1.8	1	PZ																																																																														
RC1019A0	FASCETTA ELASTICA D10 ZINCATA	11	PZ																																																																														
RC1130A0	FASCETTA 130X2,6	1	PZ																																																																														
RC1242A0	TERMINALE CHIUSO D10	2	PZ																																																																														
RC1310A0	FASCETTA RICHCO 140X4 CON CLIP	2	PZ																																																																														
RC1356A0	RACCORDO DRITTO FIL. FEMM 8X1/4 BSP	1	PZ																																																																														
RC1408A0	FASCETTA BIFILARE A MOLLA D10.8 TUBO ZN	6	PZ																																																																														
TB1818A0	TUBO 8X4.75 PE BLU	0.220	M																																																																														
TB2820A0	TUBO EPDM 6X10	1.240	M																																																																														
VI1220A1	VITE AUTOFILETTA NTE 4.2X11 TCS+ MARUTE	2	PZ																																																																														
VL1019A0	POMPA VIBRAZIONE	1	PZ																																																																														
VL1064A0	DISTRIBUTOR E USCITE CIRCUITO LAVAGGIO PL	1	PZ																																																																														
VL1065A1	PRESSOSTAT O N.O. 1/4 M CI	1	PZ																																																																														
VL1067A0	DISTRIBUTOR E INGRESSI CIRCUITO LAVAGGIO	1	PZ																																																																														
VL1080A0	FILTRO IN LINEA DETERGENTE	1	PZ																																																																														
VL1081A0	VALVOLA NON RITORNO BARBED D6	2	PZ																																																																														
VL1083A0	RACCORDO D10 - PORTAGOMM A BARBED D6	1	PZ																																																																														
VL1102A0	FILTRO IN LINEA CON VNR BARBED 6 MM	1	PZ																																																																														

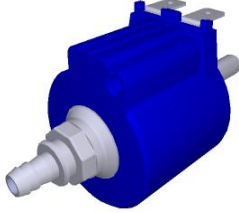
COMPONENTE			RICAMBIO																																																																		
Codice	Descrizione	Immagine	Codice	Descrizione	Lista componenti																																																																
VL1019A	POMPA VIBRAZIONE		KVL1101A	KIT IMPIANTO LAVAGGIO PLUS 1 GIRANTE EUR	<table border="1"> <thead> <tr> <th>Codice</th> <th>Descrizione</th> <th>Qtà</th> <th>UM</th> </tr> </thead> <tbody> <tr> <td>VL1102A1</td> <td>FILTRO IN LINEA DET. + VNR BARBED 6 MM</td> <td>1</td> <td>PZ</td> </tr> <tr> <td>VL1128A0</td> <td>VALVOLA VNR BARBED D6</td> <td>1</td> <td>PZ</td> </tr> <tr> <td>VM2172A0</td> <td>CLIP BLOCCAGGIO POMPA CON CIRCUITO</td> <td>1</td> <td>PZ</td> </tr> </tbody> </table>	Codice	Descrizione	Qtà	UM	VL1102A1	FILTRO IN LINEA DET. + VNR BARBED 6 MM	1	PZ	VL1128A0	VALVOLA VNR BARBED D6	1	PZ	VM2172A0	CLIP BLOCCAGGIO POMPA CON CIRCUITO	1	PZ																																																
Codice	Descrizione	Qtà	UM																																																																		
VL1102A1	FILTRO IN LINEA DET. + VNR BARBED 6 MM	1	PZ																																																																		
VL1128A0	VALVOLA VNR BARBED D6	1	PZ																																																																		
VM2172A0	CLIP BLOCCAGGIO POMPA CON CIRCUITO	1	PZ																																																																		
			KVL1094A	KIT IMPIANTO LAVAGGIO 0311 EU	<table border="1"> <thead> <tr> <th>Codice</th> <th>Descrizione</th> <th>Qtà</th> <th>UM</th> </tr> </thead> <tbody> <tr> <td>0H7494A0</td> <td>LAMIERA SUPPORTO LAVAGGIO ONE-03</td> <td>1</td> <td>PZ</td> </tr> <tr> <td>0H7494B0</td> <td>LAMIERA SUPPORTO LAVAGGIO ONE-03</td> <td>1</td> <td>PZ</td> </tr> <tr> <td>EL1436A0</td> <td>EV H2O JG D8-PORTAGO MMA D6 CHECK VALVE</td> <td>1</td> <td>PZ</td> </tr> <tr> <td>GN1526A0</td> <td>O-RING D.INT6.9 SP1.8</td> <td>1</td> <td>PZ</td> </tr> <tr> <td>RC1006A0</td> <td>CURVA GUIDA TUBO PET D8</td> <td>2</td> <td>PZ</td> </tr> <tr> <td>RC1019A0</td> <td>FASCETTA ELASTICA D10 ZINCATO</td> <td>15</td> <td>PZ</td> </tr> <tr> <td>RC1242A0</td> <td>TERMINALE CHIUSO D10</td> <td>2</td> <td>PZ</td> </tr> <tr> <td>RC1408A0</td> <td>FASCETTA BIFILARE A MOLLA D10.8 TUBO ZN</td> <td>4</td> <td>PZ</td> </tr> <tr> <td>TB1818A0</td> <td>TUBO 8X4.75 PE BLU</td> <td>0.320</td> <td>M</td> </tr> <tr> <td>TB2820A0</td> <td>TUBO EPDM 6X10</td> <td>1.030</td> <td>M</td> </tr> <tr> <td>VI1220A1</td> <td>VITE AUTOFILETTA NTE 4.2X11 TCS+ MARUTE</td> <td>1</td> <td>PZ</td> </tr> <tr> <td>VL1019A0</td> <td>POMPA VIBRAZIONE</td> <td>1</td> <td>PZ</td> </tr> <tr> <td>VL1053B0</td> <td>DISTRIBUTOR E USCITA LAVAGGIO ON</td> <td>1</td> <td>PZ</td> </tr> <tr> <td>VL1054B0</td> <td>DISTRIBUTOR E INGRESSI LAVAGGIO ON</td> <td>1</td> <td>PZ</td> </tr> <tr> <td>VL1080A0</td> <td>FILTRO IN LINEA DETERGENTE</td> <td>1</td> <td>PZ</td> </tr> </tbody> </table>	Codice	Descrizione	Qtà	UM	0H7494A0	LAMIERA SUPPORTO LAVAGGIO ONE-03	1	PZ	0H7494B0	LAMIERA SUPPORTO LAVAGGIO ONE-03	1	PZ	EL1436A0	EV H2O JG D8-PORTAGO MMA D6 CHECK VALVE	1	PZ	GN1526A0	O-RING D.INT6.9 SP1.8	1	PZ	RC1006A0	CURVA GUIDA TUBO PET D8	2	PZ	RC1019A0	FASCETTA ELASTICA D10 ZINCATO	15	PZ	RC1242A0	TERMINALE CHIUSO D10	2	PZ	RC1408A0	FASCETTA BIFILARE A MOLLA D10.8 TUBO ZN	4	PZ	TB1818A0	TUBO 8X4.75 PE BLU	0.320	M	TB2820A0	TUBO EPDM 6X10	1.030	M	VI1220A1	VITE AUTOFILETTA NTE 4.2X11 TCS+ MARUTE	1	PZ	VL1019A0	POMPA VIBRAZIONE	1	PZ	VL1053B0	DISTRIBUTOR E USCITA LAVAGGIO ON	1	PZ	VL1054B0	DISTRIBUTOR E INGRESSI LAVAGGIO ON	1	PZ	VL1080A0	FILTRO IN LINEA DETERGENTE	1	PZ
Codice	Descrizione	Qtà	UM																																																																		
0H7494A0	LAMIERA SUPPORTO LAVAGGIO ONE-03	1	PZ																																																																		
0H7494B0	LAMIERA SUPPORTO LAVAGGIO ONE-03	1	PZ																																																																		
EL1436A0	EV H2O JG D8-PORTAGO MMA D6 CHECK VALVE	1	PZ																																																																		
GN1526A0	O-RING D.INT6.9 SP1.8	1	PZ																																																																		
RC1006A0	CURVA GUIDA TUBO PET D8	2	PZ																																																																		
RC1019A0	FASCETTA ELASTICA D10 ZINCATO	15	PZ																																																																		
RC1242A0	TERMINALE CHIUSO D10	2	PZ																																																																		
RC1408A0	FASCETTA BIFILARE A MOLLA D10.8 TUBO ZN	4	PZ																																																																		
TB1818A0	TUBO 8X4.75 PE BLU	0.320	M																																																																		
TB2820A0	TUBO EPDM 6X10	1.030	M																																																																		
VI1220A1	VITE AUTOFILETTA NTE 4.2X11 TCS+ MARUTE	1	PZ																																																																		
VL1019A0	POMPA VIBRAZIONE	1	PZ																																																																		
VL1053B0	DISTRIBUTOR E USCITA LAVAGGIO ON	1	PZ																																																																		
VL1054B0	DISTRIBUTOR E INGRESSI LAVAGGIO ON	1	PZ																																																																		
VL1080A0	FILTRO IN LINEA DETERGENTE	1	PZ																																																																		

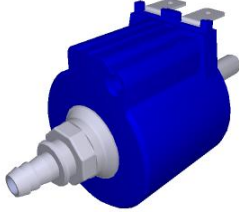

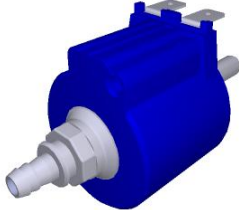
COMPONENTE			RICAMBIO																																																										
Codice	Descrizione	Immagine	Codice	Descrizione	Lista componenti																																																								
VL1019A	POMPA VIBRAZIONE		KVL1094A	KIT IMPIANTO LAVAGGIO 0311 EU	<table border="1"> <thead> <tr> <th>Codice</th> <th>Descrizione</th> <th>Qtà</th> <th>UM</th> </tr> </thead> <tbody> <tr> <td>VL1081A0</td> <td>VALVOLA NON RITORNO BARBED D6</td> <td>1</td> <td>PZ</td> </tr> <tr> <td>VL1102A0</td> <td>FILTRO IN LINEA CON VNR BARBED 6 MM</td> <td>1</td> <td>PZ</td> </tr> <tr> <td>VL1102A1</td> <td>FILTRO IN LINEA DET. + VNR BARBED 6 MM</td> <td>1</td> <td>PZ</td> </tr> <tr> <td>VL1128A0</td> <td>VALVOLA VNR BARBED D6</td> <td>1</td> <td>PZ</td> </tr> <tr> <td>VM2172A0</td> <td>CLIP BLOCCAGGIO POMPA CON CIRCUITO</td> <td>1</td> <td>PZ</td> </tr> </tbody> </table>	Codice	Descrizione	Qtà	UM	VL1081A0	VALVOLA NON RITORNO BARBED D6	1	PZ	VL1102A0	FILTRO IN LINEA CON VNR BARBED 6 MM	1	PZ	VL1102A1	FILTRO IN LINEA DET. + VNR BARBED 6 MM	1	PZ	VL1128A0	VALVOLA VNR BARBED D6	1	PZ	VM2172A0	CLIP BLOCCAGGIO POMPA CON CIRCUITO	1	PZ																																
Codice	Descrizione	Qtà	UM																																																										
VL1081A0	VALVOLA NON RITORNO BARBED D6	1	PZ																																																										
VL1102A0	FILTRO IN LINEA CON VNR BARBED 6 MM	1	PZ																																																										
VL1102A1	FILTRO IN LINEA DET. + VNR BARBED 6 MM	1	PZ																																																										
VL1128A0	VALVOLA VNR BARBED D6	1	PZ																																																										
VM2172A0	CLIP BLOCCAGGIO POMPA CON CIRCUITO	1	PZ																																																										
			KVL1092A	KIT POMPA IMPIANTO LAVAGGIO PLUS 2GIR EU	<table border="1"> <thead> <tr> <th>Codice</th> <th>Descrizione</th> <th>Qtà</th> <th>UM</th> </tr> </thead> <tbody> <tr> <td>GN1526A0</td> <td>O-RING D.INT6.9 SP1.8</td> <td>1</td> <td>PZ</td> </tr> <tr> <td>RC1019A0</td> <td>FASCETTA ELASTICA D10 ZINCATA</td> <td>4</td> <td>PZ</td> </tr> <tr> <td>RC1130A0</td> <td>FASCETTA 130X2,6</td> <td>1</td> <td>PZ</td> </tr> <tr> <td>RC1242A0</td> <td>TERMINALE CHIUSO D10</td> <td>2</td> <td>PZ</td> </tr> <tr> <td>RC1408A0</td> <td>FASCETTA BIFILARE A MOLLA D10,8 TUBO ZN</td> <td>4</td> <td>PZ</td> </tr> <tr> <td>TB2820A0</td> <td>TUBO EPDM 6X10</td> <td>0.120</td> <td>M</td> </tr> <tr> <td>VI1220A1</td> <td>VITE AUTOFILETTA NTE 4.2X11 TCS+ MARUTE</td> <td>2</td> <td>PZ</td> </tr> <tr> <td>VL1019A0</td> <td>POMPA VIBRAZIONE</td> <td>1</td> <td>PZ</td> </tr> <tr> <td>VL1067A0</td> <td>DISTRIBUTOR E INGRESSI CIRCUITO LAVAGGIO</td> <td>1</td> <td>PZ</td> </tr> <tr> <td>VL1081A0</td> <td>VALVOLA NON RITORNO BARBED D6</td> <td>1</td> <td>PZ</td> </tr> <tr> <td>VL1092A0</td> <td>DISTRIBUTOR E USCITE LAVAGGIO PLUS DOPPIA</td> <td>1</td> <td>PZ</td> </tr> <tr> <td>VL1128A0</td> <td>VALVOLA VNR BARBED D6</td> <td>1</td> <td>PZ</td> </tr> <tr> <td>VM2172A0</td> <td>CLIP BLOCCAGGIO POMPA CON CIRCUITO</td> <td>1</td> <td>PZ</td> </tr> </tbody> </table>	Codice	Descrizione	Qtà	UM	GN1526A0	O-RING D.INT6.9 SP1.8	1	PZ	RC1019A0	FASCETTA ELASTICA D10 ZINCATA	4	PZ	RC1130A0	FASCETTA 130X2,6	1	PZ	RC1242A0	TERMINALE CHIUSO D10	2	PZ	RC1408A0	FASCETTA BIFILARE A MOLLA D10,8 TUBO ZN	4	PZ	TB2820A0	TUBO EPDM 6X10	0.120	M	VI1220A1	VITE AUTOFILETTA NTE 4.2X11 TCS+ MARUTE	2	PZ	VL1019A0	POMPA VIBRAZIONE	1	PZ	VL1067A0	DISTRIBUTOR E INGRESSI CIRCUITO LAVAGGIO	1	PZ	VL1081A0	VALVOLA NON RITORNO BARBED D6	1	PZ	VL1092A0	DISTRIBUTOR E USCITE LAVAGGIO PLUS DOPPIA	1	PZ	VL1128A0	VALVOLA VNR BARBED D6	1	PZ	VM2172A0	CLIP BLOCCAGGIO POMPA CON CIRCUITO	1	PZ
Codice	Descrizione	Qtà	UM																																																										
GN1526A0	O-RING D.INT6.9 SP1.8	1	PZ																																																										
RC1019A0	FASCETTA ELASTICA D10 ZINCATA	4	PZ																																																										
RC1130A0	FASCETTA 130X2,6	1	PZ																																																										
RC1242A0	TERMINALE CHIUSO D10	2	PZ																																																										
RC1408A0	FASCETTA BIFILARE A MOLLA D10,8 TUBO ZN	4	PZ																																																										
TB2820A0	TUBO EPDM 6X10	0.120	M																																																										
VI1220A1	VITE AUTOFILETTA NTE 4.2X11 TCS+ MARUTE	2	PZ																																																										
VL1019A0	POMPA VIBRAZIONE	1	PZ																																																										
VL1067A0	DISTRIBUTOR E INGRESSI CIRCUITO LAVAGGIO	1	PZ																																																										
VL1081A0	VALVOLA NON RITORNO BARBED D6	1	PZ																																																										
VL1092A0	DISTRIBUTOR E USCITE LAVAGGIO PLUS DOPPIA	1	PZ																																																										
VL1128A0	VALVOLA VNR BARBED D6	1	PZ																																																										
VM2172A0	CLIP BLOCCAGGIO POMPA CON CIRCUITO	1	PZ																																																										

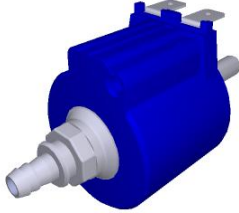

COMPONENTE			RICAMBIO																																																																																									
Codice	Descrizione	Immagine	Codice	Descrizione	Lista componenti																																																																																							
VL1019A	POMPA VIBRAZIONE		KVL1073A	KIT POMPA IMPIANTO LAVAGGIO PLUS 1GIR EU	<table border="1"> <thead> <tr> <th>Codice</th> <th>Descrizione</th> <th>Qtà</th> <th>UM</th> </tr> </thead> <tbody> <tr> <td>GN1526A0</td> <td>O-RING D.INT6.9 SP1.8</td> <td>1</td> <td>PZ</td> </tr> <tr> <td>RC1019A0</td> <td>FASCETTA ELASTICA D10 ZINCATA</td> <td>4</td> <td>PZ</td> </tr> <tr> <td>RC1130A0</td> <td>FASCETTA 130X2,6</td> <td>1</td> <td>PZ</td> </tr> <tr> <td>RC1242A0</td> <td>TERMINALE CHIUSO D10</td> <td>2</td> <td>PZ</td> </tr> <tr> <td>RC1408A0</td> <td>FASCETTA BIFILARE A MOLLA D10.8 TUBO ZN</td> <td>2</td> <td>PZ</td> </tr> <tr> <td>TB2820A0</td> <td>TUBO EPDM 6X10</td> <td>0.120</td> <td>M</td> </tr> <tr> <td>VL1019A0</td> <td>POMPA VIBRAZIONE</td> <td>1</td> <td>PZ</td> </tr> <tr> <td>VL1064A0</td> <td>DISTRIBUTOR E USCITE CIRCUITO LAVAGGIO PL</td> <td>1</td> <td>PZ</td> </tr> <tr> <td>VL1067A0</td> <td>DISTRIBUTOR E INGRESSI CIRCUITO LAVAGGIO</td> <td>1</td> <td>PZ</td> </tr> <tr> <td>VL1081A0</td> <td>VALVOLA NON RITORNO BARBED D6</td> <td>1</td> <td>PZ</td> </tr> <tr> <td>VL1128A0</td> <td>VALVOLA VNR BARBED D6</td> <td>1</td> <td>PZ</td> </tr> <tr> <td>VM2172A0</td> <td>CLIP BLOCCAGGIO POMPA CON CIRCUITO</td> <td>1</td> <td>PZ</td> </tr> </tbody> </table>	Codice	Descrizione	Qtà	UM	GN1526A0	O-RING D.INT6.9 SP1.8	1	PZ	RC1019A0	FASCETTA ELASTICA D10 ZINCATA	4	PZ	RC1130A0	FASCETTA 130X2,6	1	PZ	RC1242A0	TERMINALE CHIUSO D10	2	PZ	RC1408A0	FASCETTA BIFILARE A MOLLA D10.8 TUBO ZN	2	PZ	TB2820A0	TUBO EPDM 6X10	0.120	M	VL1019A0	POMPA VIBRAZIONE	1	PZ	VL1064A0	DISTRIBUTOR E USCITE CIRCUITO LAVAGGIO PL	1	PZ	VL1067A0	DISTRIBUTOR E INGRESSI CIRCUITO LAVAGGIO	1	PZ	VL1081A0	VALVOLA NON RITORNO BARBED D6	1	PZ	VL1128A0	VALVOLA VNR BARBED D6	1	PZ	VM2172A0	CLIP BLOCCAGGIO POMPA CON CIRCUITO	1	PZ	KVL1072A	KIT POMPA IMPIANTO LAVAGGIO ONE	<table border="1"> <thead> <tr> <th>Codice</th> <th>Descrizione</th> <th>Qtà</th> <th>UM</th> </tr> </thead> <tbody> <tr> <td>GN1526A0</td> <td>O-RING D.INT6.9 SP1.8</td> <td>1</td> <td>PZ</td> </tr> <tr> <td>RC1019A0</td> <td>FASCETTA ELASTICA D10 ZINCATA</td> <td>3</td> <td>PZ</td> </tr> <tr> <td>RC1242A0</td> <td>TERMINALE CHIUSO D10</td> <td>2</td> <td>PZ</td> </tr> <tr> <td>RC1408A0</td> <td>FASCETTA BIFILARE A MOLLA D10.8 TUBO ZN</td> <td>2</td> <td>PZ</td> </tr> <tr> <td>TB2820A0</td> <td>TUBO EPDM 6X10</td> <td>0.120</td> <td>M</td> </tr> <tr> <td>VI1220A1</td> <td>VITE AUTOFILETTA NTE 4.2X11 TCS+ MARUTE</td> <td>1</td> <td>PZ</td> </tr> <tr> <td>VL1019A0</td> <td>POMPA VIBRAZIONE</td> <td>1</td> <td>PZ</td> </tr> </tbody> </table>	Codice	Descrizione	Qtà	UM	GN1526A0	O-RING D.INT6.9 SP1.8	1	PZ	RC1019A0	FASCETTA ELASTICA D10 ZINCATA	3	PZ	RC1242A0	TERMINALE CHIUSO D10	2	PZ	RC1408A0	FASCETTA BIFILARE A MOLLA D10.8 TUBO ZN	2	PZ	TB2820A0	TUBO EPDM 6X10	0.120	M	VI1220A1	VITE AUTOFILETTA NTE 4.2X11 TCS+ MARUTE	1	PZ	VL1019A0	POMPA VIBRAZIONE	1	PZ
			Codice	Descrizione	Qtà	UM																																																																																						
GN1526A0	O-RING D.INT6.9 SP1.8	1	PZ																																																																																									
RC1019A0	FASCETTA ELASTICA D10 ZINCATA	4	PZ																																																																																									
RC1130A0	FASCETTA 130X2,6	1	PZ																																																																																									
RC1242A0	TERMINALE CHIUSO D10	2	PZ																																																																																									
RC1408A0	FASCETTA BIFILARE A MOLLA D10.8 TUBO ZN	2	PZ																																																																																									
TB2820A0	TUBO EPDM 6X10	0.120	M																																																																																									
VL1019A0	POMPA VIBRAZIONE	1	PZ																																																																																									
VL1064A0	DISTRIBUTOR E USCITE CIRCUITO LAVAGGIO PL	1	PZ																																																																																									
VL1067A0	DISTRIBUTOR E INGRESSI CIRCUITO LAVAGGIO	1	PZ																																																																																									
VL1081A0	VALVOLA NON RITORNO BARBED D6	1	PZ																																																																																									
VL1128A0	VALVOLA VNR BARBED D6	1	PZ																																																																																									
VM2172A0	CLIP BLOCCAGGIO POMPA CON CIRCUITO	1	PZ																																																																																									
Codice	Descrizione	Qtà	UM																																																																																									
GN1526A0	O-RING D.INT6.9 SP1.8	1	PZ																																																																																									
RC1019A0	FASCETTA ELASTICA D10 ZINCATA	3	PZ																																																																																									
RC1242A0	TERMINALE CHIUSO D10	2	PZ																																																																																									
RC1408A0	FASCETTA BIFILARE A MOLLA D10.8 TUBO ZN	2	PZ																																																																																									
TB2820A0	TUBO EPDM 6X10	0.120	M																																																																																									
VI1220A1	VITE AUTOFILETTA NTE 4.2X11 TCS+ MARUTE	1	PZ																																																																																									
VL1019A0	POMPA VIBRAZIONE	1	PZ																																																																																									

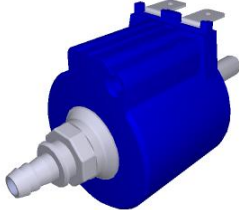

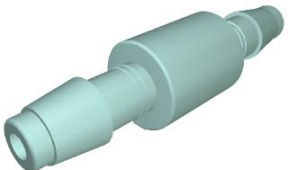

COMPONENTE			RICAMBIO																																																						
Codice	Descrizione	Immagine	Codice	Descrizione	Lista componenti																																																				
VL1019A	POMPA VIBRAZIONE		KVL1072A	KIT POMPA IMPIANTO LAVAGGIO ONE	<table border="1"> <thead> <tr> <th>Codice</th> <th>Descrizione</th> <th>Qtà</th> <th>UM</th> </tr> </thead> <tbody> <tr> <td>VL1053B0</td> <td>DISTRIBUTOR E USCITA LAVAGGIO ON</td> <td>1</td> <td>PZ</td> </tr> <tr> <td>VL1054B0</td> <td>DISTRIBUTOR E INGRESSI LAVAGGIO ON</td> <td>1</td> <td>PZ</td> </tr> <tr> <td>VL1081A0</td> <td>VALVOLA NON RITORNO BARBED D6</td> <td>2</td> <td>PZ</td> </tr> <tr> <td>VL1128A0</td> <td>VALVOLA VNR BARBED D6</td> <td>1</td> <td>PZ</td> </tr> <tr> <td>VM2172A0</td> <td>CLIP BLOCCAGGIO POMPA CON CIRCUITO</td> <td>1</td> <td>PZ</td> </tr> </tbody> </table>	Codice	Descrizione	Qtà	UM	VL1053B0	DISTRIBUTOR E USCITA LAVAGGIO ON	1	PZ	VL1054B0	DISTRIBUTOR E INGRESSI LAVAGGIO ON	1	PZ	VL1081A0	VALVOLA NON RITORNO BARBED D6	2	PZ	VL1128A0	VALVOLA VNR BARBED D6	1	PZ	VM2172A0	CLIP BLOCCAGGIO POMPA CON CIRCUITO	1	PZ																												
Codice	Descrizione	Qtà	UM																																																						
VL1053B0	DISTRIBUTOR E USCITA LAVAGGIO ON	1	PZ																																																						
VL1054B0	DISTRIBUTOR E INGRESSI LAVAGGIO ON	1	PZ																																																						
VL1081A0	VALVOLA NON RITORNO BARBED D6	2	PZ																																																						
VL1128A0	VALVOLA VNR BARBED D6	1	PZ																																																						
VM2172A0	CLIP BLOCCAGGIO POMPA CON CIRCUITO	1	PZ																																																						
			KVL0001A	KIT IMPIANTO LAVAGGIO LM TOP	<table border="1"> <thead> <tr> <th>Codice</th> <th>Descrizione</th> <th>Qtà</th> <th>UM</th> </tr> </thead> <tbody> <tr> <td>0H1226A0</td> <td>LAMIERA CIRCUITO LAVAGGIO LINEMISS</td> <td>1</td> <td>PZ</td> </tr> <tr> <td>0H1226B0</td> <td>LAMIERA CIRCUITO LAVAGGIO LINEMISS</td> <td>1</td> <td>PZ</td> </tr> <tr> <td>EL1180A0</td> <td>RACCORDO NON RITORNO Ø8 Ø8 FEMMIN</td> <td>1</td> <td>PZ</td> </tr> <tr> <td>GN1312A0</td> <td>PASSACAVO GOMMA DE=26 DI=15 SP=10</td> <td>1</td> <td>PZ</td> </tr> <tr> <td>GN1526A0</td> <td>O-RING D.INT6.9 SP1.8</td> <td>1</td> <td>PZ</td> </tr> <tr> <td>RC1008A0</td> <td>FASCETTA ELASTICA D9 ZINCATA</td> <td>3</td> <td>PZ</td> </tr> <tr> <td>RC1019A0</td> <td>FASCETTA ELASTICA D10 ZINCATA</td> <td>3</td> <td>PZ</td> </tr> <tr> <td>RC1242A0</td> <td>TERMINALE CHIUSO D10</td> <td>2</td> <td>PZ</td> </tr> <tr> <td>RC1381A0</td> <td>BIFILARI STRINGI TUBO D10.7 ZINCAT</td> <td>3</td> <td>PZ</td> </tr> <tr> <td>RC1408A0</td> <td>FASCETTA BIFILARE A MOLLA D10.8 TUBO ZN</td> <td>2</td> <td>PZ</td> </tr> <tr> <td>TB2343A0</td> <td>TUBO PVC TRASPARENT E 9X6</td> <td>2.630</td> <td>M</td> </tr> <tr> <td>TB2820A0</td> <td>TUBO EPDM 6X10</td> <td>0.990</td> <td>M</td> </tr> </tbody> </table>	Codice	Descrizione	Qtà	UM	0H1226A0	LAMIERA CIRCUITO LAVAGGIO LINEMISS	1	PZ	0H1226B0	LAMIERA CIRCUITO LAVAGGIO LINEMISS	1	PZ	EL1180A0	RACCORDO NON RITORNO Ø8 Ø8 FEMMIN	1	PZ	GN1312A0	PASSACAVO GOMMA DE=26 DI=15 SP=10	1	PZ	GN1526A0	O-RING D.INT6.9 SP1.8	1	PZ	RC1008A0	FASCETTA ELASTICA D9 ZINCATA	3	PZ	RC1019A0	FASCETTA ELASTICA D10 ZINCATA	3	PZ	RC1242A0	TERMINALE CHIUSO D10	2	PZ	RC1381A0	BIFILARI STRINGI TUBO D10.7 ZINCAT	3	PZ	RC1408A0	FASCETTA BIFILARE A MOLLA D10.8 TUBO ZN	2	PZ	TB2343A0	TUBO PVC TRASPARENT E 9X6	2.630	M	TB2820A0	TUBO EPDM 6X10	0.990	M
Codice	Descrizione	Qtà	UM																																																						
0H1226A0	LAMIERA CIRCUITO LAVAGGIO LINEMISS	1	PZ																																																						
0H1226B0	LAMIERA CIRCUITO LAVAGGIO LINEMISS	1	PZ																																																						
EL1180A0	RACCORDO NON RITORNO Ø8 Ø8 FEMMIN	1	PZ																																																						
GN1312A0	PASSACAVO GOMMA DE=26 DI=15 SP=10	1	PZ																																																						
GN1526A0	O-RING D.INT6.9 SP1.8	1	PZ																																																						
RC1008A0	FASCETTA ELASTICA D9 ZINCATA	3	PZ																																																						
RC1019A0	FASCETTA ELASTICA D10 ZINCATA	3	PZ																																																						
RC1242A0	TERMINALE CHIUSO D10	2	PZ																																																						
RC1381A0	BIFILARI STRINGI TUBO D10.7 ZINCAT	3	PZ																																																						
RC1408A0	FASCETTA BIFILARE A MOLLA D10.8 TUBO ZN	2	PZ																																																						
TB2343A0	TUBO PVC TRASPARENT E 9X6	2.630	M																																																						
TB2820A0	TUBO EPDM 6X10	0.990	M																																																						

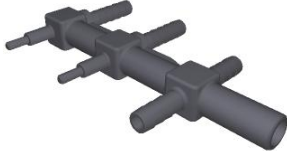

COMPONENTE			RICAMBIO																																																																						
Codice	Descrizione	Immagine	Codice	Descrizione	Lista componenti																																																																				
VL1019A	POMPA VIBRAZIONE		KVL0001A	KIT IMPIANTO LAVAGGIO LM TOP	<table border="1"> <thead> <tr> <th>Codice</th> <th>Descrizione</th> <th>Qtà</th> <th>UM</th> </tr> </thead> <tbody> <tr> <td>VI1220A1</td> <td>VITE AUTOFILETTA NTE 4.2X11 TCS+ MARUTE</td> <td>1</td> <td>PZ</td> </tr> <tr> <td>VL1019A0</td> <td>POMPA VIBRAZIONE</td> <td>1</td> <td>PZ</td> </tr> <tr> <td>VL1041C0</td> <td>TAPPO DETERGENTE FORATO Ø12</td> <td>1</td> <td>PZ</td> </tr> <tr> <td>VL1047A1</td> <td>PORTAGOMM A D6 CODOLO D8</td> <td>1</td> <td>PZ</td> </tr> <tr> <td>VL1053A1</td> <td>CIRCUITO LAVAGGIO POMPA USCIT</td> <td>1</td> <td>PZ</td> </tr> <tr> <td>VL1053B0</td> <td>DISTRIBUTOR E USCITA LAVAGGIO ON</td> <td>1</td> <td>PZ</td> </tr> <tr> <td>VL1054A1</td> <td>CIRCUITO LAVAGGIO POMPA INGRESSI</td> <td>1</td> <td>PZ</td> </tr> <tr> <td>VL1054B0</td> <td>DISTRIBUTOR E INGRESSI LAVAGGIO ON</td> <td>1</td> <td>PZ</td> </tr> <tr> <td>VL1061A0</td> <td>FILTRO RETINATO+AF FONDANTE+V NR XFT200</td> <td>1</td> <td>PZ</td> </tr> <tr> <td>VL1081A0</td> <td>VALVOLA NON RITORNO BARBED D6</td> <td>1</td> <td>PZ</td> </tr> <tr> <td>VL1128A0</td> <td>VALVOLA VNR BARBED D6</td> <td>2</td> <td>PZ</td> </tr> <tr> <td>VM1066A0</td> <td>CLIP A SELLA PASSAGGIO CAVI</td> <td>3</td> <td>PZ</td> </tr> <tr> <td>VM1088A0</td> <td>FASCETTA A SCATTO D7.9-D9.2 PP</td> <td>1</td> <td>PZ</td> </tr> <tr> <td>VM1605A0</td> <td>CLIP TWIST LOCK DIAM. 10.2-12.7 MM</td> <td>1</td> <td>PZ</td> </tr> <tr> <td>VM1610A0</td> <td>CLIP TWIST LOCK DIAM. 7.6-10.2 MM</td> <td>1</td> <td>PZ</td> </tr> <tr> <td>VM2172A0</td> <td>CLIP BLOCCAGGIO POMPA CON CIRCUITO</td> <td>1</td> <td>PZ</td> </tr> </tbody> </table>	Codice	Descrizione	Qtà	UM	VI1220A1	VITE AUTOFILETTA NTE 4.2X11 TCS+ MARUTE	1	PZ	VL1019A0	POMPA VIBRAZIONE	1	PZ	VL1041C0	TAPPO DETERGENTE FORATO Ø12	1	PZ	VL1047A1	PORTAGOMM A D6 CODOLO D8	1	PZ	VL1053A1	CIRCUITO LAVAGGIO POMPA USCIT	1	PZ	VL1053B0	DISTRIBUTOR E USCITA LAVAGGIO ON	1	PZ	VL1054A1	CIRCUITO LAVAGGIO POMPA INGRESSI	1	PZ	VL1054B0	DISTRIBUTOR E INGRESSI LAVAGGIO ON	1	PZ	VL1061A0	FILTRO RETINATO+AF FONDANTE+V NR XFT200	1	PZ	VL1081A0	VALVOLA NON RITORNO BARBED D6	1	PZ	VL1128A0	VALVOLA VNR BARBED D6	2	PZ	VM1066A0	CLIP A SELLA PASSAGGIO CAVI	3	PZ	VM1088A0	FASCETTA A SCATTO D7.9-D9.2 PP	1	PZ	VM1605A0	CLIP TWIST LOCK DIAM. 10.2-12.7 MM	1	PZ	VM1610A0	CLIP TWIST LOCK DIAM. 7.6-10.2 MM	1	PZ	VM2172A0	CLIP BLOCCAGGIO POMPA CON CIRCUITO	1	PZ
Codice	Descrizione	Qtà	UM																																																																						
VI1220A1	VITE AUTOFILETTA NTE 4.2X11 TCS+ MARUTE	1	PZ																																																																						
VL1019A0	POMPA VIBRAZIONE	1	PZ																																																																						
VL1041C0	TAPPO DETERGENTE FORATO Ø12	1	PZ																																																																						
VL1047A1	PORTAGOMM A D6 CODOLO D8	1	PZ																																																																						
VL1053A1	CIRCUITO LAVAGGIO POMPA USCIT	1	PZ																																																																						
VL1053B0	DISTRIBUTOR E USCITA LAVAGGIO ON	1	PZ																																																																						
VL1054A1	CIRCUITO LAVAGGIO POMPA INGRESSI	1	PZ																																																																						
VL1054B0	DISTRIBUTOR E INGRESSI LAVAGGIO ON	1	PZ																																																																						
VL1061A0	FILTRO RETINATO+AF FONDANTE+V NR XFT200	1	PZ																																																																						
VL1081A0	VALVOLA NON RITORNO BARBED D6	1	PZ																																																																						
VL1128A0	VALVOLA VNR BARBED D6	2	PZ																																																																						
VM1066A0	CLIP A SELLA PASSAGGIO CAVI	3	PZ																																																																						
VM1088A0	FASCETTA A SCATTO D7.9-D9.2 PP	1	PZ																																																																						
VM1605A0	CLIP TWIST LOCK DIAM. 10.2-12.7 MM	1	PZ																																																																						
VM1610A0	CLIP TWIST LOCK DIAM. 7.6-10.2 MM	1	PZ																																																																						
VM2172A0	CLIP BLOCCAGGIO POMPA CON CIRCUITO	1	PZ																																																																						

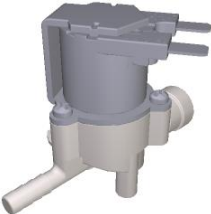
COMPONENTE			RICAMBIO																																										
Codice	Descrizione	Immagine	Codice	Descrizione	Lista componenti																																								
VM2172A	CLIP BLOCCAGGIO POMPA CON CIRCUITO		VM2172A0	CLIP BLOCCAGGIO POMPA CON CIRCUITO																																									
RC1019A	FASCETTA ELASTICA D10 ZINCATA		KRC1019A	KIT 15 PZ. FASCETTA ELASTICA D10 ZINCATA	<table border="1"> <thead> <tr> <th>Codice</th> <th>Descrizione</th> <th>Qtà</th> <th>UM</th> </tr> </thead> <tbody> <tr> <td>RC1019A0</td> <td>FASCETTA ELASTICA D10 ZINCATA</td> <td>15</td> <td>PZ</td> </tr> </tbody> </table>	Codice	Descrizione	Qtà	UM	RC1019A0	FASCETTA ELASTICA D10 ZINCATA	15	PZ																																
Codice	Descrizione	Qtà	UM																																										
RC1019A0	FASCETTA ELASTICA D10 ZINCATA	15	PZ																																										
VL1081A	VALVOLA NON RITORNO BARBED D		KVL1128A  KVL1102A  KVL1081A	KIT VALVOLA VNR BARBED D6  KIT FILTRO IN LINEA DETERGENTE CON VNR  KIT 2 PZ VALVOLA NON RITORNO BARBED D6	<table border="1"> <thead> <tr> <th>Codice</th> <th>Descrizione</th> <th>Qtà</th> <th>UM</th> </tr> </thead> <tbody> <tr> <td>RC1019A0</td> <td>FASCETTA ELASTICA D10 ZINCATA</td> <td>2</td> <td>PZ</td> </tr> <tr> <td>TB2820A0</td> <td>TUBO EPDM 6X10</td> <td>0.080</td> <td>M</td> </tr> <tr> <td>VL1128A0</td> <td>VALVOLA VNR BARBED D6</td> <td>1</td> <td>PZ</td> </tr> <tr> <td>RC1019A0</td> <td>FASCETTA ELASTICA D10 ZINCATA</td> <td>3</td> <td>PZ</td> </tr> <tr> <td>TB2820A0</td> <td>TUBO EPDM 6X10</td> <td>0.110</td> <td>M</td> </tr> <tr> <td>VL1102A0</td> <td>FILTRO IN LINEA CON VNR BARBED 6 MM</td> <td>1</td> <td>PZ</td> </tr> <tr> <td>VL1102A1</td> <td>FILTRO IN LINEA DET. + VNR BARBED 6 MM</td> <td>1</td> <td>PZ</td> </tr> <tr> <td>TB2820A0</td> <td>TUBO EPDM 6X10</td> <td>0.240</td> <td>M</td> </tr> <tr> <td>VL1081A0</td> <td>VALVOLA NON RITORNO BARBED D6</td> <td>3</td> <td>PZ</td> </tr> </tbody> </table>	Codice	Descrizione	Qtà	UM	RC1019A0	FASCETTA ELASTICA D10 ZINCATA	2	PZ	TB2820A0	TUBO EPDM 6X10	0.080	M	VL1128A0	VALVOLA VNR BARBED D6	1	PZ	RC1019A0	FASCETTA ELASTICA D10 ZINCATA	3	PZ	TB2820A0	TUBO EPDM 6X10	0.110	M	VL1102A0	FILTRO IN LINEA CON VNR BARBED 6 MM	1	PZ	VL1102A1	FILTRO IN LINEA DET. + VNR BARBED 6 MM	1	PZ	TB2820A0	TUBO EPDM 6X10	0.240	M	VL1081A0	VALVOLA NON RITORNO BARBED D6	3	PZ
Codice	Descrizione	Qtà	UM																																										
RC1019A0	FASCETTA ELASTICA D10 ZINCATA	2	PZ																																										
TB2820A0	TUBO EPDM 6X10	0.080	M																																										
VL1128A0	VALVOLA VNR BARBED D6	1	PZ																																										
RC1019A0	FASCETTA ELASTICA D10 ZINCATA	3	PZ																																										
TB2820A0	TUBO EPDM 6X10	0.110	M																																										
VL1102A0	FILTRO IN LINEA CON VNR BARBED 6 MM	1	PZ																																										
VL1102A1	FILTRO IN LINEA DET. + VNR BARBED 6 MM	1	PZ																																										
TB2820A0	TUBO EPDM 6X10	0.240	M																																										
VL1081A0	VALVOLA NON RITORNO BARBED D6	3	PZ																																										

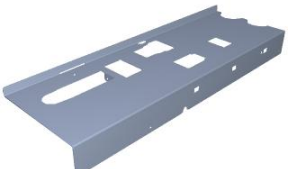
COMPONENTE			RICAMBIO																																																						
Codice	Descrizione	Immagine	Codice	Descrizione	Lista componenti																																																				
RC1242A	TERMINALE CHIUSO D10		KRC1242A	KIT 20 PZ.TERMINALE CHIUSO T10	<table border="1"> <thead> <tr> <th>Codice</th> <th>Descrizione</th> <th>Qtà</th> <th>UM</th> </tr> </thead> <tbody> <tr> <td>RC1242A0</td> <td>TERMINALE CHIUSO D10</td> <td>20</td> <td>PZ</td> </tr> </tbody> </table>	Codice	Descrizione	Qtà	UM	RC1242A0	TERMINALE CHIUSO D10	20	PZ																																												
Codice	Descrizione	Qtà	UM																																																						
RC1242A0	TERMINALE CHIUSO D10	20	PZ																																																						
VL1054B	DISTRIBUTORE INGRESSI LAVAGGIO ONE		KVL1054B	KIT DISTRIBUTORE INGRESSI LAVAGGIO ONE	<table border="1"> <thead> <tr> <th>Codice</th> <th>Descrizione</th> <th>Qtà</th> <th>UM</th> </tr> </thead> <tbody> <tr> <td>VL1054B0</td> <td>DISTRIBUTOR E INGRESSI LAVAGGIO ON</td> <td>1</td> <td>PZ</td> </tr> </tbody> </table>	Codice	Descrizione	Qtà	UM	VL1054B0	DISTRIBUTOR E INGRESSI LAVAGGIO ON	1	PZ																																												
Codice	Descrizione	Qtà	UM																																																						
VL1054B0	DISTRIBUTOR E INGRESSI LAVAGGIO ON	1	PZ																																																						
VL1053B	DISTRIBUTORE USCITA LAVAGGIO ONE		KVL1072A	KIT POMPA IMPIANTO LAVAGGIO ONE	<table border="1"> <thead> <tr> <th>Codice</th> <th>Descrizione</th> <th>Qtà</th> <th>UM</th> </tr> </thead> <tbody> <tr> <td>GN1526A0</td> <td>O-RING D.INT6.9 SP1.8</td> <td>1</td> <td>PZ</td> </tr> <tr> <td>RC1019A0</td> <td>FASCETTA ELASTICA D10 ZINCATA</td> <td>3</td> <td>PZ</td> </tr> <tr> <td>RC1242A0</td> <td>TERMINALE CHIUSO D10</td> <td>2</td> <td>PZ</td> </tr> <tr> <td>RC1408A0</td> <td>FASCETTA BIFILARE A MOLLA D10.8 TUBO ZN</td> <td>2</td> <td>PZ</td> </tr> <tr> <td>TB2820A0</td> <td>TUBO EPDM 6X10</td> <td>0.120</td> <td>M</td> </tr> <tr> <td>VI1220A1</td> <td>VITE AUTOFILETTA NTE 4.2X11 TCS+ MARUTE</td> <td>1</td> <td>PZ</td> </tr> <tr> <td>VL1019A0</td> <td>POMPA VIBRAZIONE</td> <td>1</td> <td>PZ</td> </tr> <tr> <td>VL1053B0</td> <td>DISTRIBUTOR E USCITA LAVAGGIO ON</td> <td>1</td> <td>PZ</td> </tr> <tr> <td>VL1054B0</td> <td>DISTRIBUTOR E INGRESSI LAVAGGIO ON</td> <td>1</td> <td>PZ</td> </tr> <tr> <td>VL1081A0</td> <td>VALVOLA NON RITORNO BARBED D6</td> <td>2</td> <td>PZ</td> </tr> <tr> <td>VL1128A0</td> <td>VALVOLA VNR BARBED D6</td> <td>1</td> <td>PZ</td> </tr> <tr> <td>VM2172A0</td> <td>CLIP BLOCCAGGIO POMPA CON CIRCUITO</td> <td>1</td> <td>PZ</td> </tr> </tbody> </table>	Codice	Descrizione	Qtà	UM	GN1526A0	O-RING D.INT6.9 SP1.8	1	PZ	RC1019A0	FASCETTA ELASTICA D10 ZINCATA	3	PZ	RC1242A0	TERMINALE CHIUSO D10	2	PZ	RC1408A0	FASCETTA BIFILARE A MOLLA D10.8 TUBO ZN	2	PZ	TB2820A0	TUBO EPDM 6X10	0.120	M	VI1220A1	VITE AUTOFILETTA NTE 4.2X11 TCS+ MARUTE	1	PZ	VL1019A0	POMPA VIBRAZIONE	1	PZ	VL1053B0	DISTRIBUTOR E USCITA LAVAGGIO ON	1	PZ	VL1054B0	DISTRIBUTOR E INGRESSI LAVAGGIO ON	1	PZ	VL1081A0	VALVOLA NON RITORNO BARBED D6	2	PZ	VL1128A0	VALVOLA VNR BARBED D6	1	PZ	VM2172A0	CLIP BLOCCAGGIO POMPA CON CIRCUITO	1	PZ
Codice	Descrizione	Qtà	UM																																																						
GN1526A0	O-RING D.INT6.9 SP1.8	1	PZ																																																						
RC1019A0	FASCETTA ELASTICA D10 ZINCATA	3	PZ																																																						
RC1242A0	TERMINALE CHIUSO D10	2	PZ																																																						
RC1408A0	FASCETTA BIFILARE A MOLLA D10.8 TUBO ZN	2	PZ																																																						
TB2820A0	TUBO EPDM 6X10	0.120	M																																																						
VI1220A1	VITE AUTOFILETTA NTE 4.2X11 TCS+ MARUTE	1	PZ																																																						
VL1019A0	POMPA VIBRAZIONE	1	PZ																																																						
VL1053B0	DISTRIBUTOR E USCITA LAVAGGIO ON	1	PZ																																																						
VL1054B0	DISTRIBUTOR E INGRESSI LAVAGGIO ON	1	PZ																																																						
VL1081A0	VALVOLA NON RITORNO BARBED D6	2	PZ																																																						
VL1128A0	VALVOLA VNR BARBED D6	1	PZ																																																						
VM2172A0	CLIP BLOCCAGGIO POMPA CON CIRCUITO	1	PZ																																																						

COMPONENTE			RICAMBIO																						
Codice	Descrizione	Immagine	Codice	Descrizione	Lista componenti																				
RC1408A	FASCETTA BIFILARE A MOLLA D10.8 TUBO ZN		KRC1408A	KIT FASCETTA BIFILARE A MOLLA D10.8 4PZ	<table border="1"> <thead> <tr> <th>Codice</th> <th>Descrizione</th> <th>Qtà</th> <th>UM</th> </tr> </thead> <tbody> <tr> <td>RC1408A0</td> <td>FASCETTA BIFILARE A MOLLA D10.8 TUBO ZN</td> <td>4</td> <td>PZ</td> </tr> </tbody> </table>	Codice	Descrizione	Qtà	UM	RC1408A0	FASCETTA BIFILARE A MOLLA D10.8 TUBO ZN	4	PZ												
Codice	Descrizione	Qtà	UM																						
RC1408A0	FASCETTA BIFILARE A MOLLA D10.8 TUBO ZN	4	PZ																						
EL1436A	EV H2O JG D8-PORTAGOMMA D6 CHECK VALVE		KEL1436A	KIT EV H2O JG D8-PORTAGOMMA D6 VNR	<table border="1"> <thead> <tr> <th>Codice</th> <th>Descrizione</th> <th>Qtà</th> <th>UM</th> </tr> </thead> <tbody> <tr> <td>EL1436A0</td> <td>EV H2O JG D8-PORTAGO MMA D6 CHECK VALVE</td> <td>1</td> <td>PZ</td> </tr> </tbody> </table>	Codice	Descrizione	Qtà	UM	EL1436A0	EV H2O JG D8-PORTAGO MMA D6 CHECK VALVE	1	PZ												
Codice	Descrizione	Qtà	UM																						
EL1436A0	EV H2O JG D8-PORTAGO MMA D6 CHECK VALVE	1	PZ																						
TB3009B	TB3132A-TUBO INGRESSO LAVAGGIO ONE		KTB1349A	KIT TB1818A - TUBO 8X4,75 PE BLU L=30	<table border="1"> <thead> <tr> <th>Codice</th> <th>Descrizione</th> <th>Qtà</th> <th>UM</th> </tr> </thead> <tbody> <tr> <td>TB1818A0</td> <td>TUBO 8X4.75 PE BLU</td> <td>30</td> <td>M</td> </tr> </tbody> </table>	Codice	Descrizione	Qtà	UM	TB1818A0	TUBO 8X4.75 PE BLU	30	M												
Codice	Descrizione	Qtà	UM																						
TB1818A0	TUBO 8X4.75 PE BLU	30	M																						
0H7819A	SUPPORTO LAVAGGIO ONE CON ELV STEAM		0H7819A0	SUPPORTO LAVAGGIO ONE CON ELV STEAM																					
VL1102A	FILTRO IN LINEA DET. + VNR BARBED 6 MM		KVL1102A	KIT FILTRO IN LINEA DETERGENTE CON VNR	<table border="1"> <thead> <tr> <th>Codice</th> <th>Descrizione</th> <th>Qtà</th> <th>UM</th> </tr> </thead> <tbody> <tr> <td>RC1019A0</td> <td>FASCETTA ELASTICA D10 ZINCATA</td> <td>3</td> <td>PZ</td> </tr> <tr> <td>TB2820A0</td> <td>TUBO EPDM 6X10</td> <td>0.110</td> <td>M</td> </tr> <tr> <td>VL1102A0</td> <td>FILTRO IN LINEA CON VNR BARBED 6 MM</td> <td>1</td> <td>PZ</td> </tr> <tr> <td>VL1102A1</td> <td>FILTRO IN LINEA DET. + VNR BARBED 6 MM</td> <td>1</td> <td>PZ</td> </tr> </tbody> </table>	Codice	Descrizione	Qtà	UM	RC1019A0	FASCETTA ELASTICA D10 ZINCATA	3	PZ	TB2820A0	TUBO EPDM 6X10	0.110	M	VL1102A0	FILTRO IN LINEA CON VNR BARBED 6 MM	1	PZ	VL1102A1	FILTRO IN LINEA DET. + VNR BARBED 6 MM	1	PZ
Codice	Descrizione	Qtà	UM																						
RC1019A0	FASCETTA ELASTICA D10 ZINCATA	3	PZ																						
TB2820A0	TUBO EPDM 6X10	0.110	M																						
VL1102A0	FILTRO IN LINEA CON VNR BARBED 6 MM	1	PZ																						
VL1102A1	FILTRO IN LINEA DET. + VNR BARBED 6 MM	1	PZ																						