

CUCINE TUTTAPIASTRA A GAS

Serie 1100

TIPO: 110/90TCTG, 110/90CTG, 110/90CTGG, 110/90CTGE

Parti di ricambio



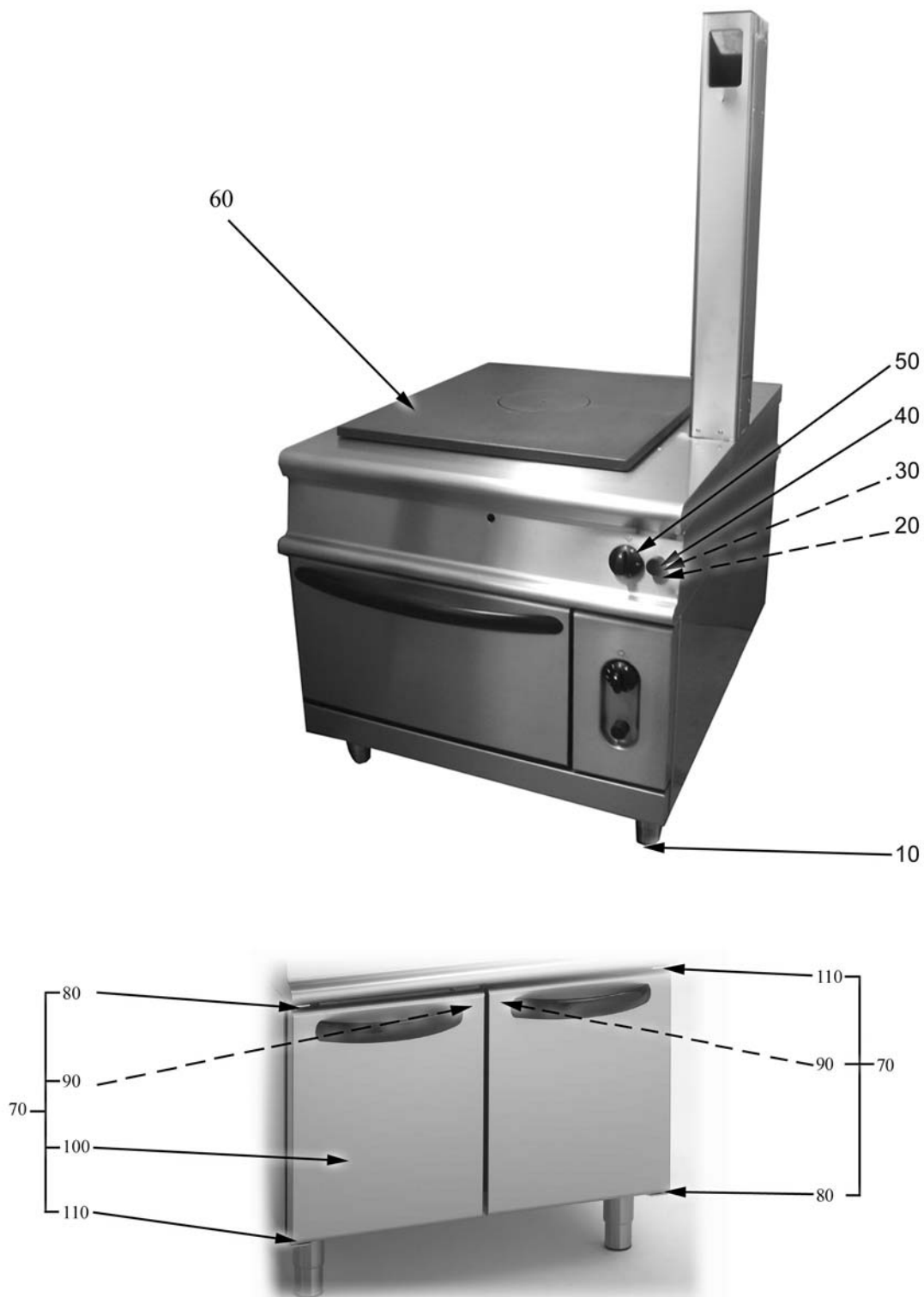

Parti di ricambio

ID	Tipo	Descrizione	Codici
Module:Parti esterne e kit porte			
10		Piedino	826490142
20		Accensione piezoelettrica	6A041105
30		Rondella	822160540
40		Cappuccio	826630420
50		Manopola rubinetto	2599200
60		Piastra	826901070
70	90	Kit porta	2593510
80	90	Cerniera inferiore destra superiore sinistra porta	2547870
90	90	Magnete	826900011
100	90	Porta	2593160
110	90	Cerniera inferiore sinistra superiore destra porta	2547860

90T=110/90TCTG, 90=110/90CTG, 90G=110/90CTGG, 90E=110/90CTGE

A=3/N/PE~400/230V 50Hz, H=3/PE~230V 50Hz

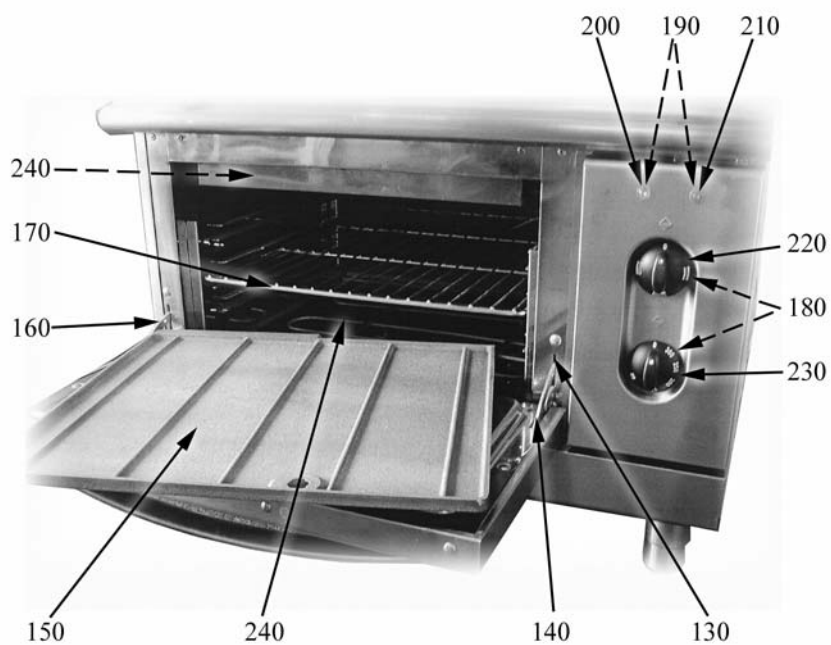
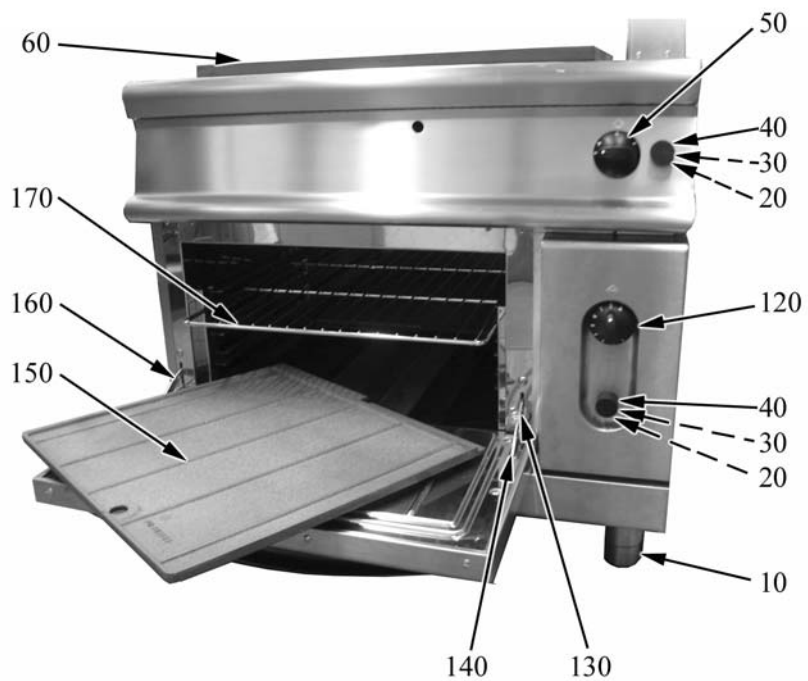

Parti di ricambio

ID	Tipo	Descrizione	Codici
Module: Parti esterne forno gas ed elettrico			
10	90G,90E	Piedino	826490142
20		Accensione piezoelettrica	6A041105
30		Rondella	822160540
40		Cappuccio	826630420
50		Manopola rubinetto	2599200
60		Piastra	826901070
120	90G	Manopola nera per forno gas	2599202
130	90G,90E	Portarullini per cerniera	6A035930
140	90G,90E	Cerniera dx	6A035910
150	90G,90E	Suola forno	6A001010
160	90G,90E	Cerniera sx	6A035920
170	90G,90E	Griglia	826330120
180	90E	Guarnizione manopola	2519490
190	90E	Segnalatori luminosi	6A038506
200	90E	Gemma bianca	6A039207
210	90E	Gemma verde	6A038507
220	90E	Manopola commutatore forno elettrico nera	2599207
230	90E	Manopola forno elettrico nera	2599208
240	90E	Resistenza 1500 W	826620041

90T=110/90TCTG, 90=110/90CTG, 90G=110/90CTGG, 90E=110/90CTGE

A=3/N/PE~400/230V 50Hz, H=3/PE~230V 50Hz

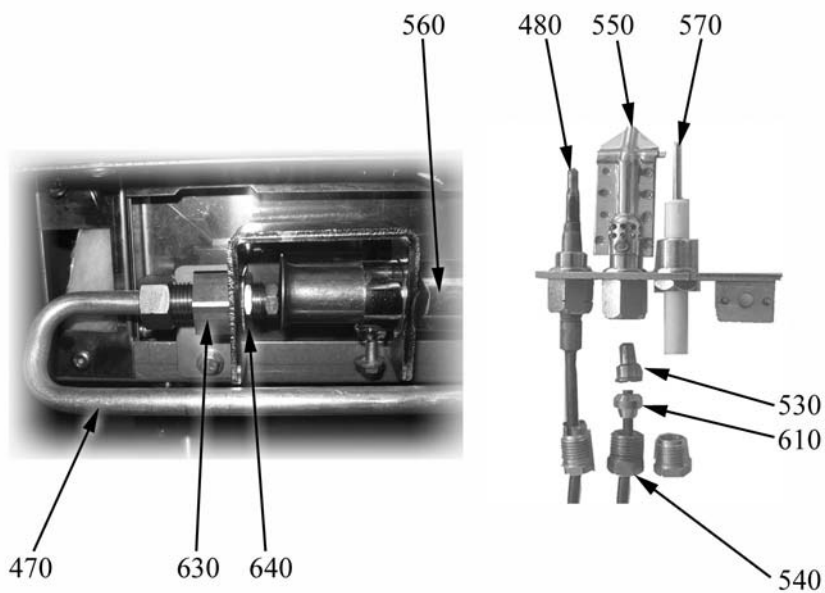
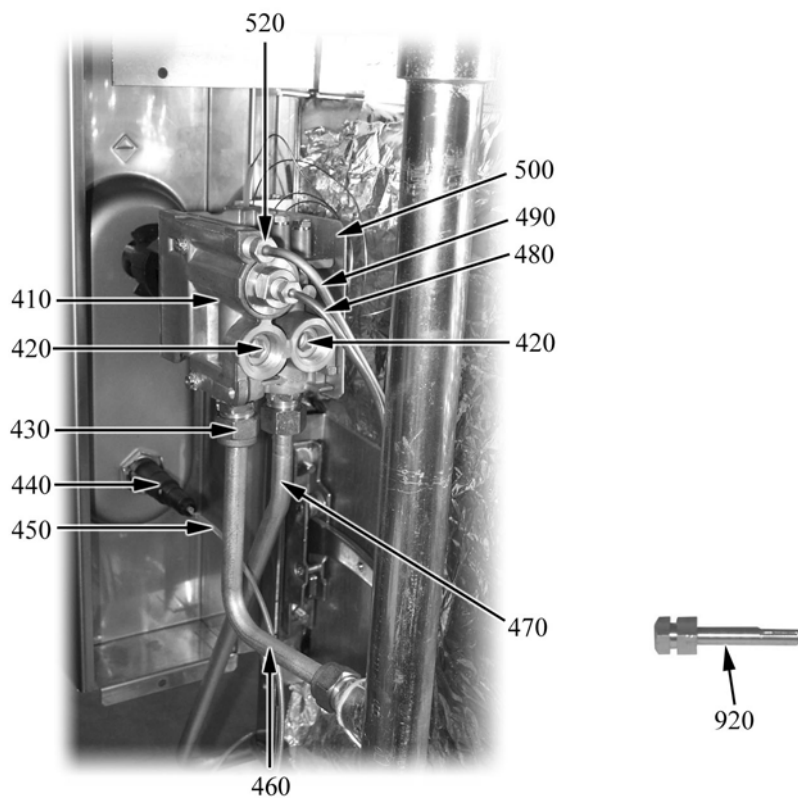

ID	Tipo	Descrizione	Codici
Module: Componenti forno a gas (valvola,condutture)			
410	90G	Valvola	8219950
420	90G	Tappo	8219951
430	90G	Raccordo	822450170
440	90G	Accensione piezoelettrica	6A041105
450	90G	Cavo d'accensione	2510698
460	90G	Conduttura	2514615
470	90G	Conduttura	41823560461
480	90G	Termocoppia	826920080
490	90G	Conduttura	2516030
500	90G	Squadretta	821120710
520	90G	Raccordo bicono	6A011608
530	90G	Ugello 16.2	6A013240
530	90G	Ugello 27.2	6A013230
530	90G	Ugello 38R	2510332
530	90G	Ugello 32.2	2510334
540	90G	Dado	6A017000
550	90G	Pilota	6A013220
560	90G	Bruciatore	826390081
570	90G	Candela	6A013302
610	90G	Bicono	6A016900
630	90G	Portaugello	822450440
640	90G	Dado M15x1	822180010
920	90G	Attacco manopola	2518650

90T=110/90TCTG, 90=110/90CTG, 90G=110/90CTGG, 90E=110/90CTGE

A=3/N/PE~400/230V 50Hz, H=3/PE~230V 50Hz

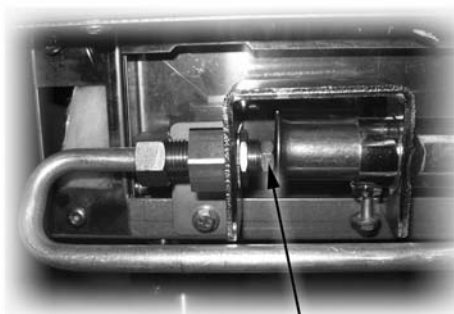

710

Parti di ricambio

ID	Tipo	Descrizione	Codici
Module:Ugelli forno a gas			
710	90G	Kit ugelli IT forno	2591980
-	90G	Ugello BA 255	
-	90G	Ugello 270	
-	90G	Ugello 170	
-	90G	Ugello 27.2	
-	90G	Ugello 16.2	
710	90G	Kit ugelli DE forno	2591981
-	90G	Ugello BA 255	
-	90G	Ugello BA 145	
-	90G	Ugello 295	
-	90G	Ugello 27.2	
-	90G	Ugello 16.2	
710	90G	Kit ugelli H forno	2591982
-	90G	Ugello 170	
-	90G	Ugello BA 240	
-	90G	Ugello BA 285	
-	90G	Ugello 27.2	
-	90G	Ugello 16.2	
-	90G	Ugello 38	
710	90G	Kit ugelli PL forno	2591983
-	90G	Ugello BA 155	
-	90G	Ugello BA 255	
-	90G	Ugello 310	
-	90G	Ugello 27.2	
-	90G	Ugello 16.2	
-	90G	Ugello 32.2	

90T=110/90TCTG, 90=110/90CTG, 90G=110/90CTGG, 90E=110/90CTGE

A=3/N/PE~400/230V 50Hz, H=3/PE~230V 50Hz



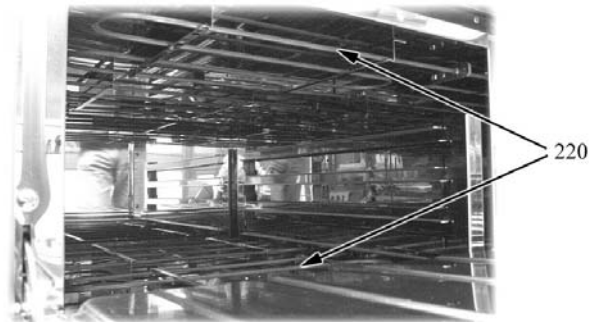
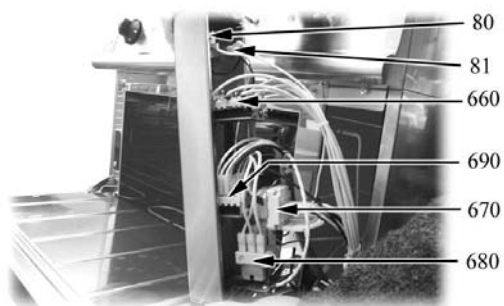

Parti di ricambio

ID	Tipo	Descrizione	Codici
Module: Componenti forno elettrico			
190	90E	Segnalatori luminosi	6A038506
200	90E	Gemma bianca	6A039207
210	90E	Gemma verde	6A038507
240	90E	Resistenza 1500 W	826620041
660	90E	Commutatore	6A046750
670	90E	Termostato	6A044601
680	90E	Termostato sicurezza	826630130
690	90E	Commutatore	6A046001
740	90E	Contattore	6A047031

90T=110/90TCTG, 90=110/90CTG, 90G=110/90CTGG, 90E=110/90CTGE

A=3/N/PE~400/230V 50Hz, H=3/PE~230V 50Hz

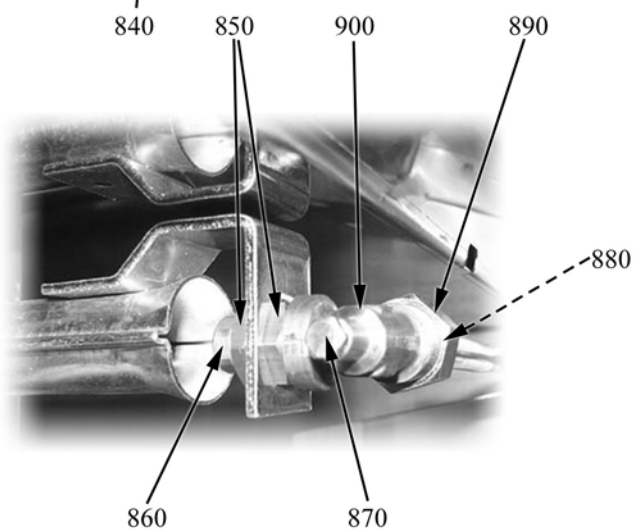
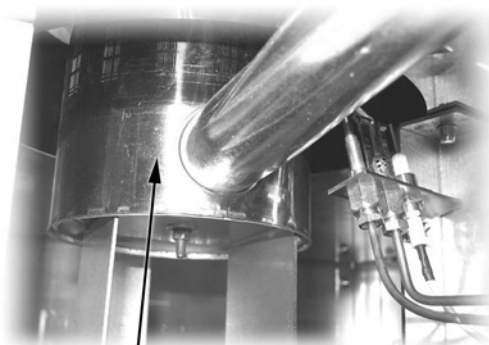
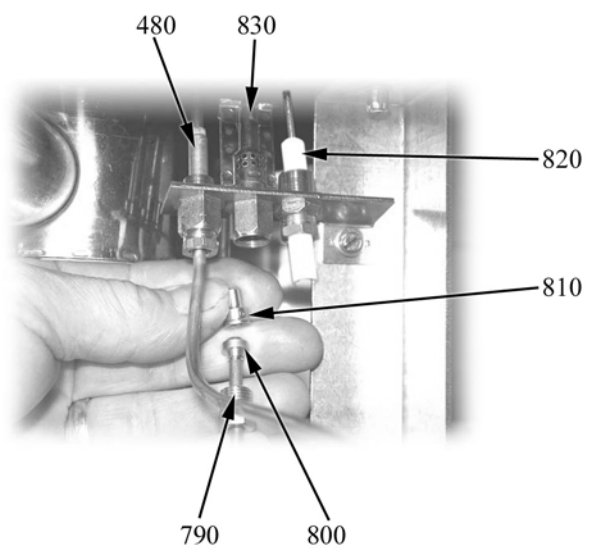

Parti di ricambio

ID	Tipo	Descrizione	Codici
Module:Pilota e bruciatore tuttapiastra			
480		Termocoppia	6A011904
790		Dado	6A017000
800		Bicono	6A016900
810		Ugello 27.2	6A013230
810		Ugello 16.2	6A013240
810		Ugello 38R	2510332
810		Ugello 32.2	2510334
820		Candela di accensione	6A013302
830		Pilota	6A013220
840		Bruciatore tuttapiastra	2510069
850		Controdado	6A010820

90T=110/90TCTG, 90=110/90CTG, 90G=110/90CTGG, 90E=110/90CTGE

A=3/N/PE~400/230V 50Hz, H=3/PE~230V 50Hz

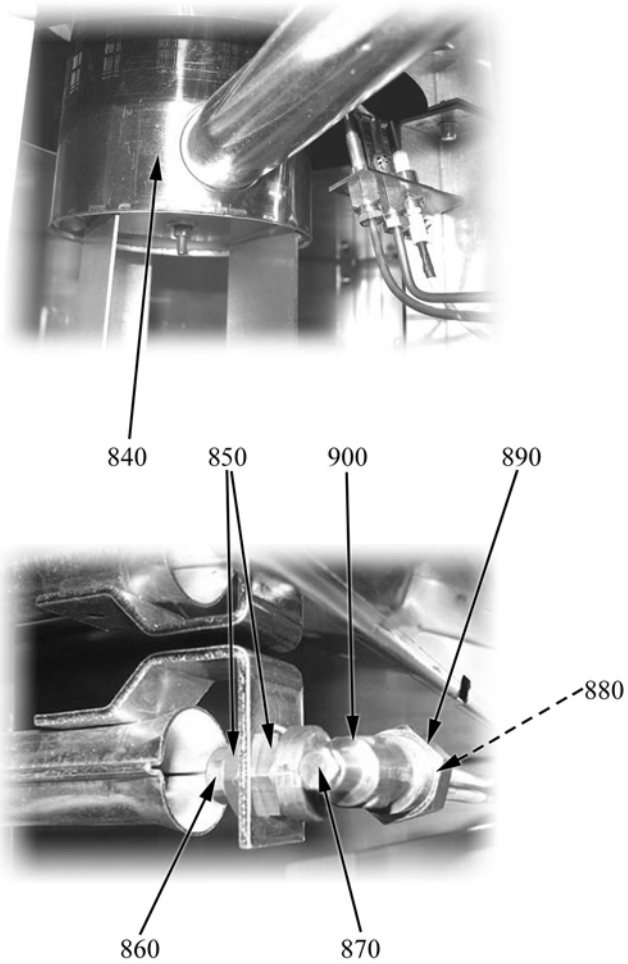
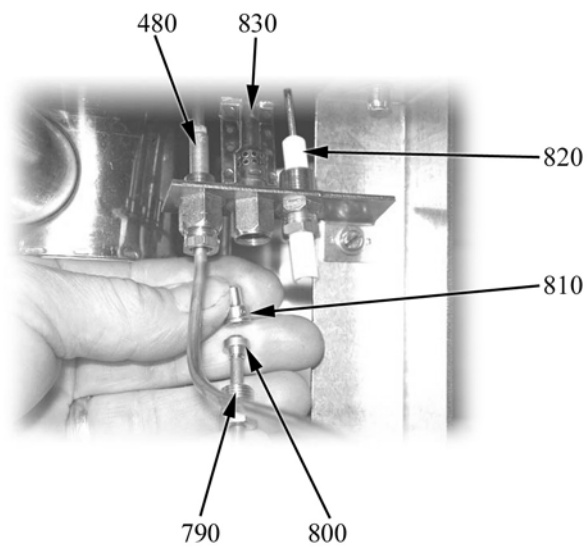

ID	Tipo	Descrizione	Codici
Module:Pilota e bruciatore tuttapietra			
860		Kit ugelli IT bruciatore	2591875
-		Ugello L 180	
-		Ugello L 275	
-		Ugello L 290	
-		Ugello 16.2	
-		Ugello 27.2	
-		By pass	
860		Kit ugelli DE bruciatore	2591876
-		Ugello L 155	
-		Ugello L 275	
-		Ugello L 310	
-		Ugello 16.2	
-		Ugello 27.2	
-		By pass	
860		Kit ugelli H bruciatore	2591877
-		Ugello L 180	
-		Ugello L 260	
-		Ugello L 295	
-		Ugello 16.2	
-		Ugello 27.2	
-		Ugello 38R	
-		By pass	
860		Kit ugelli PL bruciatore	2591878
-		Ugello L 170	
-		Ugello L 275	
-		Ugello L 325	
-		Ugello L 440	
-		Ugello 32.2	
-		Ugello 27.2	
-		Ugello 16.2	
-		By pass	
870		Vite	2510610
880		Bicono	6A011470
890		Dado	6A011475
900		Raccordo	6A014708

90T=110/90TCTG, 90=110/90CTG, 90G=110/90CTGG, 90E=110/90CTGE

A=3/N/PE~400/230V 50Hz, H=3/PE~230V 50Hz



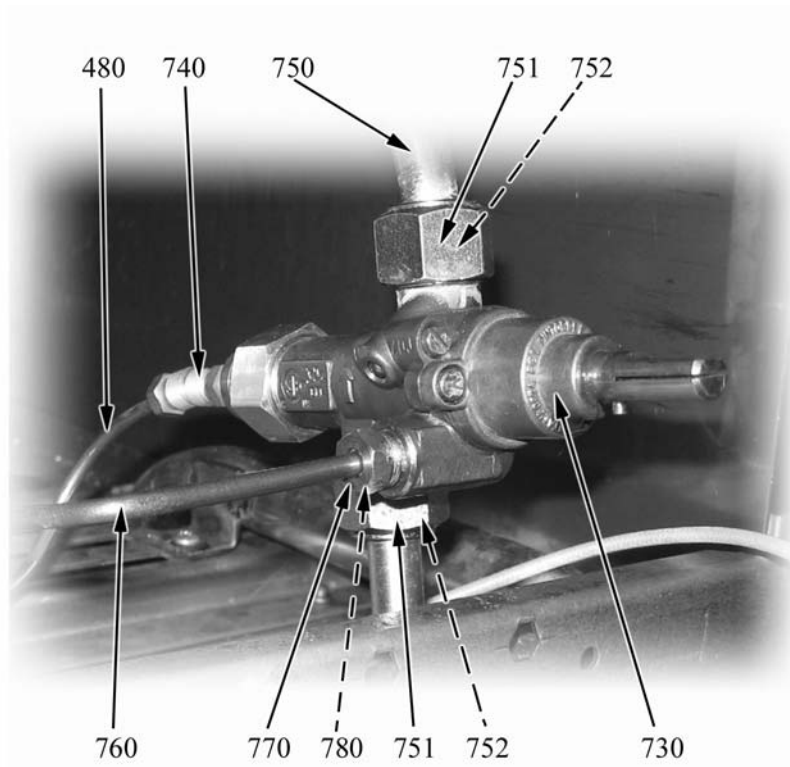

Parti di ricambio

ID	Tipo	Descrizione	Codici
Module:Rubinetto			
480		Termocoppia	6A011904
730		Rubinetto	6A011490
740		Raccordo	6A013401
750		Conduttura	2516086
751		Dado di fissaggio	6A011485
752		Bicono	6A011480
760		Conduttura	2516085
770		Dado	6A017000
780		Bicono	6A016900

90T=110/90TCTG, 90=110/90CTG, 90G=110/90CTGG, 90E=110/90CTGE

A=3/N/PE~400/230V 50Hz, H=3/PE~230V 50Hz