

POS.	CODE	PIECES	DESCRIPTION
1	R18206060	1	DOOR
2	R18206070	1	INNER DOOR PANEL
3	R71201520	1	INNER DOOR GLASS
4	R58001760	2	INNER GLASS SOLID HINGE
5	R58001770	2	INNER GLASS HINGE PIN
6	R58001780	2	INNER GLASS CATCH KIT
7	R11401340	2	TOP "C" PROFILE
8	R18203910	1	LOWER SUPPORT GLASS
9	R18203920	1	TOP SUPPORT GLASS
10	R18404500	1	LOWER DOOR HINGE
11	R58002520	1	LOWER HINGE PIN
12	R11200560	1	UPPER DOOR HINGE
13	R58002150	1	HINGE PIN
14	R58004050	2	NUT FOR UPPER DOOR HINGE
15	R10401710	1	WASHER FOR UPPER DOOR HINGE
16	R70050100	6	GLASS SILICON SPACERS
17	R70044150	1	GLASS GASKET
18	R66110320	1	DOOR LAMPS CABLE SET
19	R11401440	1	LAMP COVER
20	R71500150	1	GLASS LAMP
21	R70044200	1	LAMP GASKET

POS.	CODE	PIECES	DESCRIPTION
22	R11401450	1	GLASS HOLDER LAMP FLANGE
23	R65270020	1	LIGHT 20W 12V G4
24	R65270450	1	LIGHT SOCKET
25	R65260750	1	LAMPS CONTACT BLOCK
26	R66110300	1	LAMPS CONTACT CABLE SET
27	R69015000	1	DOOR HANDLE ASSEMBLY
28	R09200230	1	DOOR HANDLE
29	R10100110	1	PRONG FLANGE
30	R58003240	1	DOOR HANDLE BUTTON ROD
31	R58004270	1	DOOR HANDLE SPACER
32	R58004830	1	RING NUT M18x1
33	R58005050	1	DOOR HANDLE PRONG
34	R58005340	1	DOOR HANDLE LOWER INSULATION WASHER
35	R58005350	1	DOOR HANDLE UPPER INSULATION WASHER
36	R61620012	1	DOOR HANDLE CATCH SPRING
37	R61620041	1	DOOR HANDLE BUTTON SPRING
38	R69031190	1	DOOR HANDLE PUSH BUTTON
39	R58002160	1	DOOR HANDLE PRONG PIN
40	R18202020	1	DOOR HANDLE PRONG COUPLER

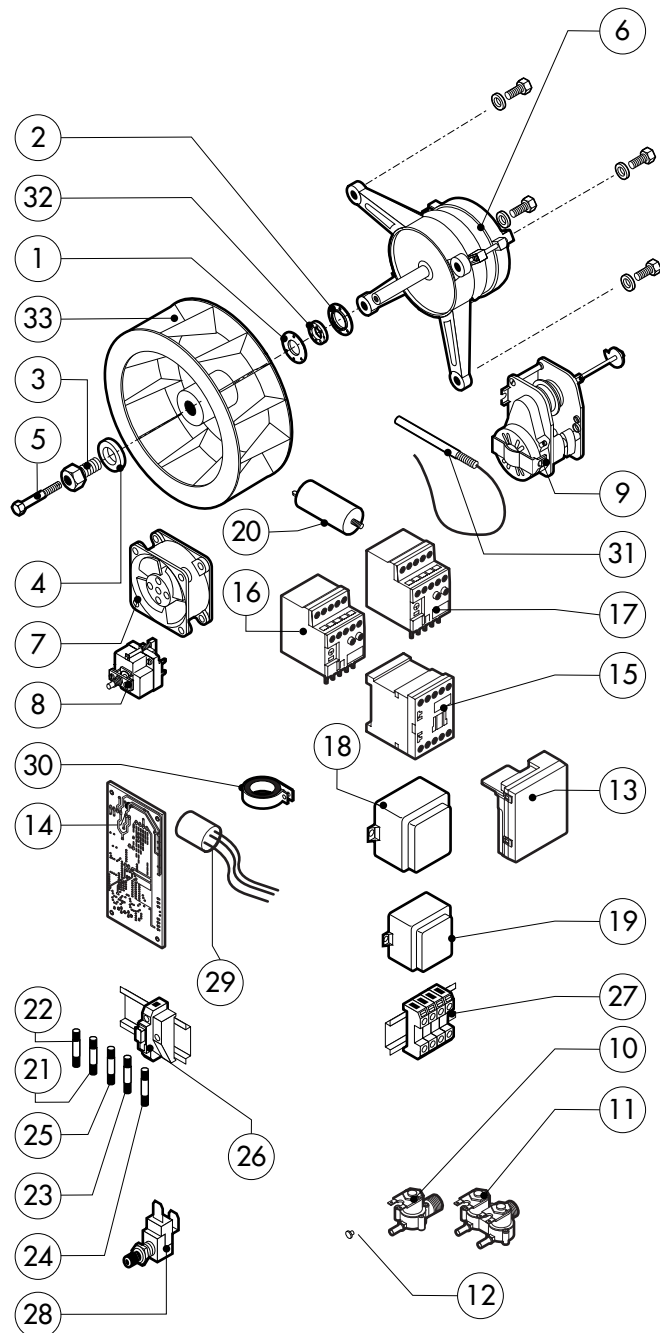
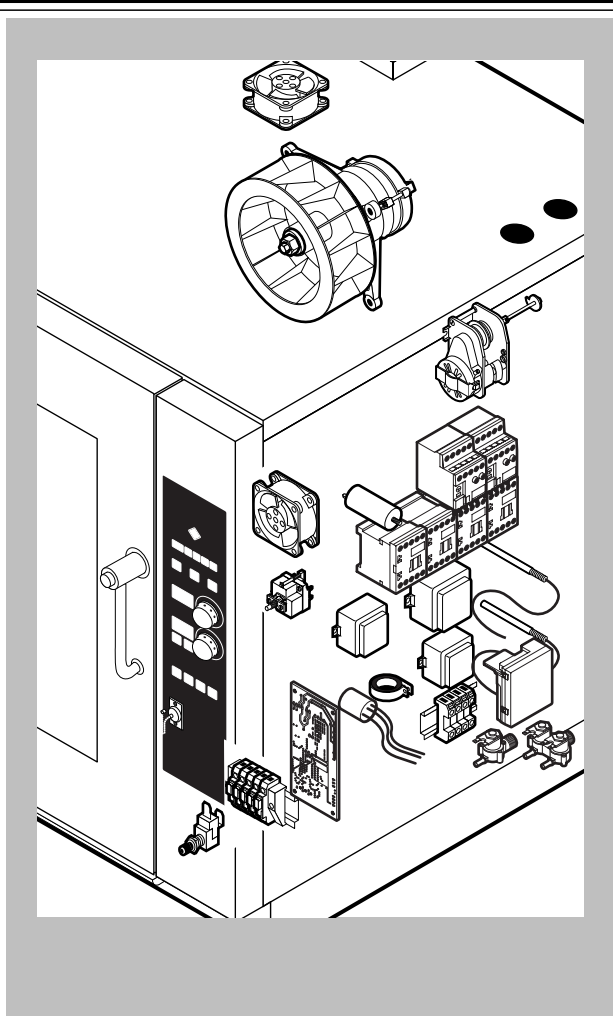

POS.	CODE	PIECES	DESCRIPTION
1	R58003840	1	MOTOR GASKET BRASS FLANGE
2	R58003850	1	MOTOR GASKET BRASS COUNTER FLANGE
3	R58004000	1	FAN SCREW M12x1.5 SX
4	R58004010	1	FAN WASHER Ø 30/12.5
5	R61020562	1	FAN SCREW TE A2 M6x55
6	*R65040540	1	MOTOR 055/015 KW KIT
7	R65060050	2	COMPONENTS VENTILATION MOTOR Ø 120
8	R65070350	1	CHAMBER SAFETY THERMOSTAT
9	R65095000	1	DAMPER SYSTEM
10	R65110200	1	SOLENOID VALVE 220V 50HZ
11	R65110230	1	SOLENOID VALVE 220V 50HZ WITH FLOW REDUCER
12	R65110520	1	22 LT/H WATER FLOW REDUCER
13	R63060120	1	BURNER IGNITION PANEL
14	R63130020	1	GAS BURNER FAN MOTOR PCBOARD
15	*R65140550	4	CONTACTOR DIL 00 M-01 4KW
16	*R65160460	1	THERMIC PROTECTION Z 00-2,4
17	*R65160470	1	THERMIC PROTECTION Z 00-4
18	R65180770	1	TRANSFORMER 50VA
19	R65180420	2	TRANSFORMER 20VA
20	*R65190180	1	CAPACITOR 20 µF
21	R65200200	1	FUSE 2A

POS.	CODE	PIECES	DESCRIPTION
22	R65200120	1	FUSE 1A
23	R65200040	1	FUSE 0.500A (T)
24	R65200320	1	FUSE 0.25A (T)
25	R65200080	1	FUSE 0.125A (T)
26	R65210020	5	FUSE CARRIER
27	R65220220	1	TERMINAL BOARD
28	R65260540	1	DOOR SWITCH
29	*R65280210	1	INTERFERENCE SUPPRESSOR
30	*R65280450	1	FERRITE
31	R65325000	2	PROBE PT100
32	R70020050	1	MOTOR GASKET
33	*R75400440	1	FAN Ø 350x114/12 50HZ P.D. KIT

*COMPONENT SUBMITTED TO CHANGEMENTS CAUSED BY TENSION DIFFERENT FROM THE STANDARD (AC 230V 50HZ)

