

POS.	CODE	PIECES	DESCRIPTION
1	R03200970	1	DOOR LOCK REAR FLANGE
2	R10201290	1	UPPER DOOR HINGE
3	R10201330	1	LOWER DOOR HINGE WITH RETAINER
4	R10202950	1	LOWER DOOR ROD
5	R10202960	1	UPPER DOOR ROD
6	R10207680	2	DOOR ROD ADJUSTABLE PLATE
7	R10208290	1	FRONT LOWER DOOR PANEL CATCH
8	R10208300	1	FRONT UPPER DOOR PANEL CATCH
9	R10208340	1	FRONT DOOR PANEL
10	R10213710	1	DOOR
11	R10400150	2	LIGHT PROTECTION
12	R10411350	1	LOWER SQUARE FOR DOOR ROD
13	R10411360	1	UPPER SQUARE FOR DOOR ROD
14	R10456040	2	LOWER HINGE FOR FRONT DOOR PANEL
15	R10456050	1	UPPER HINGE FOR FRONT DOOR PANEL
16	R10458750	1	INNER DOOR PANEL
17	R58002150	1	HINGE PIN
18	R58002540	1	DOOR PIVOT SUNK KEY
19	R58002550	1	DOOR RETAINER GUIDE SHOE

POS.	CODE	PIECES	DESCRIPTION
20	R58002560	1	SCREW FOR LOWER DOOR HINGE
21	R58002570	1	WASHER Ø 30/15x3
22	R58003180	1	DOOR HANDLE PIN
23	R58003450	1	DOOR HANDLE
24	R58004050	1	NUT FOR UPPER DOOR HINGE
25	R58004781	1	DOOR HANDLE HOOK
26	R61040272	1	DOOR HANDLE HOOK SCREW
27	R61090052	1	GRUB SCREW M6x16
28	R61100262	1	GRUB SCREW M8x20
29	R61420021	1	ELASTIC WASHER
30	R61620091	16	BELLEVILLE WASHER Ø 14/6.4
31	R65270020	2	LIGHT 20W 12V G4
32	R65270400	2	LIGHT SOCKET
33	R69015050	1	DOOR HANDLE ASSEMBLY
34	R70040200	4	GLASS GASKET
35	R70040800	2	LIGHT PROTECTION GASKET
36	R70042150	1	DOOR GASKET
37	R71030120	2	DOOR GLASS

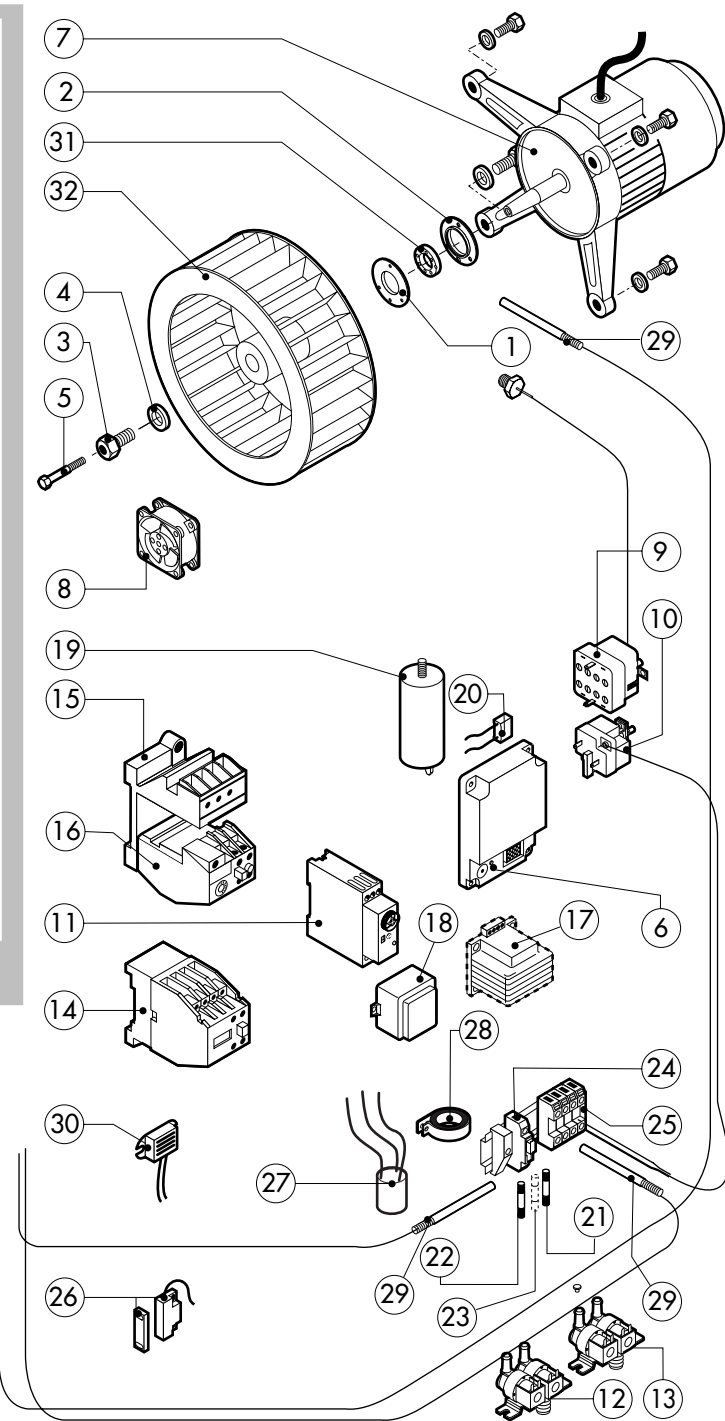
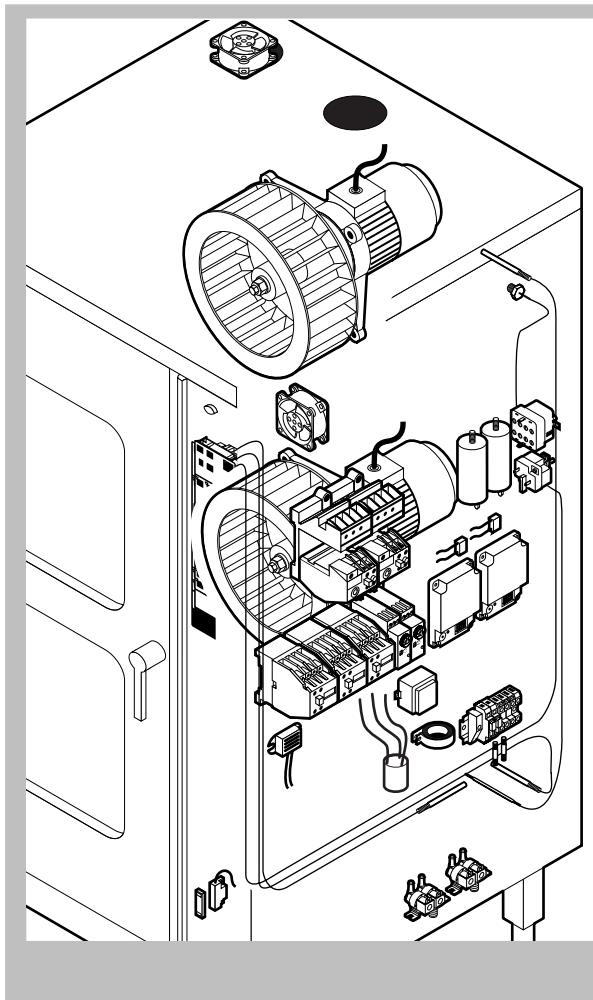

POS.	CODE	PIECES	DESCRIPTION
1	R58003840	2	MOTOR GASKET BRASS FLANGE
2	R58003850	2	MOTOR GASKET BRASS COUNTER FLANGE
3	R58004000	2	FAN SCREW M12x1.5 SX
4	R58004010	2	FAN WASHER Ø 30/12.5
5	R61020562	2	FAN SCREW TE A2 M6x55
6	R63060080	2	BURNER IGNITION PANEL WR 50A72-214
7	R65040041	2	MOTOR HP 1 KIT
8	R65060050	2	COMPONENTS VENTILATION MOTOR Ø 120
9	R65070070	1	CHAMBER SAFETY THERMOSTAT
10	R65070080	1	STEAM GENERATOR SAFETY THERMOSTAT
11	R65090450	2	IGNITION DELAY TIMER
12	R65110040	1	SOLENOID VALVE 220V 50HZ
13	R65115000	1	SOLENOID VALVE 220V 50HZ WITH FLOW REDUCER
14	R65140150	3	CONTACTOR 3TF4011-OAUO 240V
15	R65160050	2	THERMIC SWITCH SUPPORT 3UX1418
16	R65160130	2	THERMIC PROTECTION 3UA5000-1F 3.2-5A
17	R65180430	1	TRANSFORMER 40VA
18	R65180650	1	TRANSFORMER 23VA
19	R65190030	2	CAPACITOR 16 µF

POS.	CODE	PIECES	DESCRIPTION
20	R65190200	2	INTERFERENCE SUPPRESSOR
21	R65200200	1	FUSE 2A
22	R65200320	1	FUSE 0.2A (T)
23	R65200350	1	FUSE 0.4A (T)
24	R65210020	3	FUSE CARRIER
25	R65220220	1	TERMINAL BOARD
26	R65265100	1	DOOR SWITCH
27	R65280200	1	INTERFERENCE SUPPRESSOR
28	R65280450	1	FERRITE
29	R65325000	3	PROBE PT100
30	R65330020	1	BUZZER
31	R70020050	2	MOTOR GASKET
32	R75400290	2	FAN Ø 300x120/20 50HZ P.D. KIT

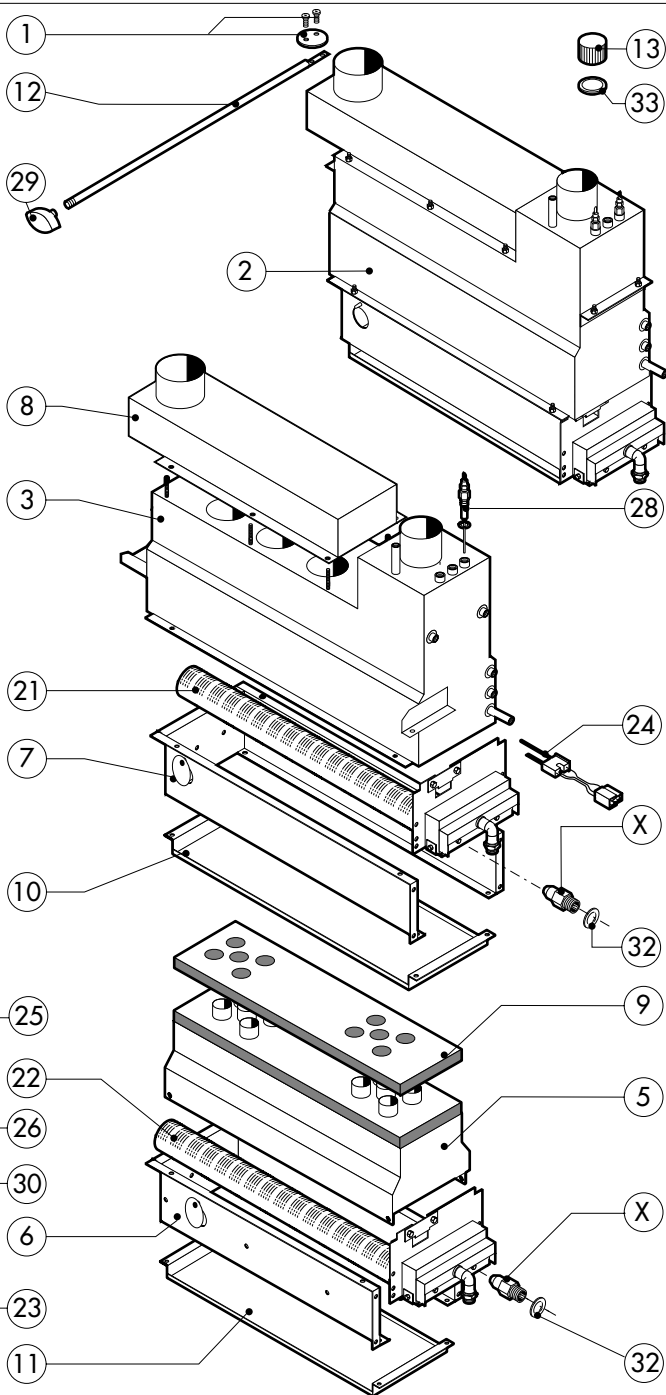
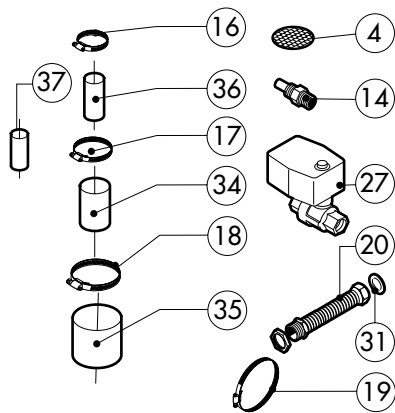
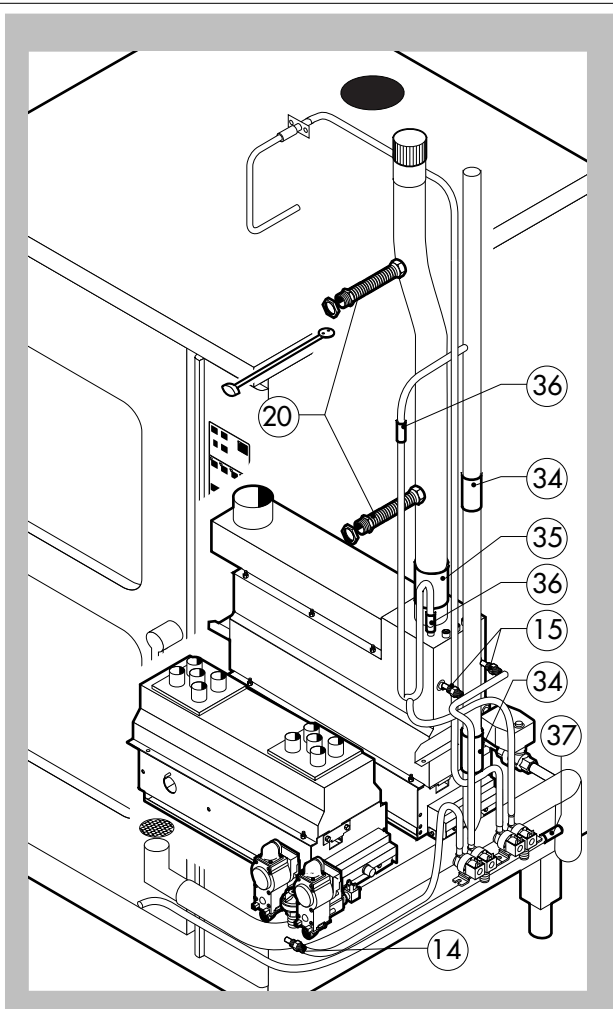

POS.	CODE	PIECES	DESCRIPTION
1	R04403460	1	CHAMBER VENT PLATE Ø 46
2	R10102160	1	STEAM GENERATOR ASSEMBLY
3	R10201000	1	STEAM GENERATOR
4	R10201710	1	DRAIN FILTER
5	R10202410	1	COMBUSTION CABINET
6	R10202530	1	CABINET BURNERS SUPPORT
7	R10202600	1	STEAM GENERATOR SUPPORT
8	R10211860	1	STEAM GENERATOR GAS FLUE PIPE
9	R10406250	1	COMBUSTION CABINET INSULATION PLATE
10	R10409400	1	STEAM GENERATOR BURNERS PROTECTION PLATE
11	R10411650	1	CHAMBER BURNERS PROTECTION PLATE
12	R58003510	1	CHAMBER VENT ROD
13	R58005680	1	STEAM GENERATOR DESCALING CAP 1"1/4 F
14	R58006080	1	STEAM QUENCHING NOZZLE Ø 2
15	R58006110	2	STEAM GENERATOR FLUSHING NOZZLE
16	R61630011	12	METAL CLAMPS 12-22/9
17	R61630021	2	METAL CLAMPS 30-45/9
18	R61630031	2	METAL CLAMPS 40-60/9
19	R61630071	4	METAL CLAMPS 110-130/9
20	R62180022	2	FLEXIBLE STEEL PIPE Ø 20x3/4" ASSEMBLY

POS.	CODE	PIECES	DESCRIPTION
21	R63016100	1	STEAM GENERATOR BURNER ASSEMBLY
22	R63016110	1	CHAMBER BURNER ASSEMBLY
23	R63020010	2	GAS SOLENOID VALVE VR4605
24	R63050040	2	IGNITOR/SENSOR WR 768G213
25	R63070010	1	GAS SAFETY PRESSURE SWITCH PG 901.61
26	R63080020	4	CURVED FLANGE 1/2"
27	R65110540	1	STEAM GENERATOR DRAIN MOTORIZED VALVE
28	R65320010	2	STEAM GENERATOR LEVEL PROBE
29	R69010410	1	STEAM OUTLET KNOB
30	R70010070	4	RING
31	R70030050	2	GASKET Ø 16x24 3/4"
32	R70030090	3	NOZZLE GASKET
33	R70050040	1	STEAM GENERATOR CAP GASKET
34	R70060010	2	SILICON COUPLING Ø 30
35	R70060040	1	SILICON COUPLING Ø 50
36	R70060060	2	SILICON COUPLING Ø 15
37	R70060080	1	SILICON COUPLING Ø 13
X		2	NOZZLE (See service manual)
X		2	NOZZLE (See service manual)

