

POS.	CODE	PIECES	DESCRIPTION
1	R09200230	1	DOOR HANDLE
2	R10100110	1	PRONG FLANGE
3	R10201190	1	LOWER DOOR HINGE
4	R10201290	1	UPPER DOOR HINGE
5	R10208290	1	FRONT LOWER DOOR PANEL CATCH
6	R10208300	1	FRONT UPPER DOOR PANEL CATCH
7	R10208330	1	FRONT DOOR PANEL
8	R10212240	1	DOOR
9	R10400150	2	LIGHT PROTECTION
10	R10401710	1	WASHER FOR UPPER DOOR HINGE
11	R10408130	1	INNER DOOR PANEL
12	R10442370	1	DOOR DRIP TRAY
13	R10456040	1	LOWER HINGE FOR FRONT DOOR PANEL
14	R10456050	1	UPPER HINGE FOR FRONT DOOR PANEL
15	R58002150	1	HINGE PIN
16	R58002160	1	DOOR HANDLE PRONG PIN
17	R58002760	1	DOOR HANDLE PRONG COUPLER
18	R58003240	1	DOOR HANDLE BUTTON ROD
19	R58004050	1	NUT FOR UPPER DOOR HINGE

POS.	CODE	PIECES	DESCRIPTION
20	R58004270	1	DOOR HANDLE SPACER
21	R58004830	1	RING NUT M18x1
22	R58005050	1	DOOR HANDLE PRONG
23	R58005340	1	DOOR HANDLE LOWER INSULATION WASHER
24	R58005350	1	DOOR HANDLE UPPER INSULATION WASHER
25	R61620012	1	DOOR HANDLE CATCH SPRING
26	R61620041	1	DOOR HANDLE BUTTON SPRING
27	R65270020	2	LIGHT 20W 12V G4
28	R65270400	2	LIGHT SOCKET
29	R69015000	1	DOOR HANDLE ASSEMBLY
30	R69031190	1	DOOR HANDLE PUSH BUTTON
31	R70040200	2	GLASS GASKET
32	R70040800	2	LIGHT PROTECTION GASKET
33	R70042030	1	DOOR GASKET
34	R71030120	1	DOOR GLASS

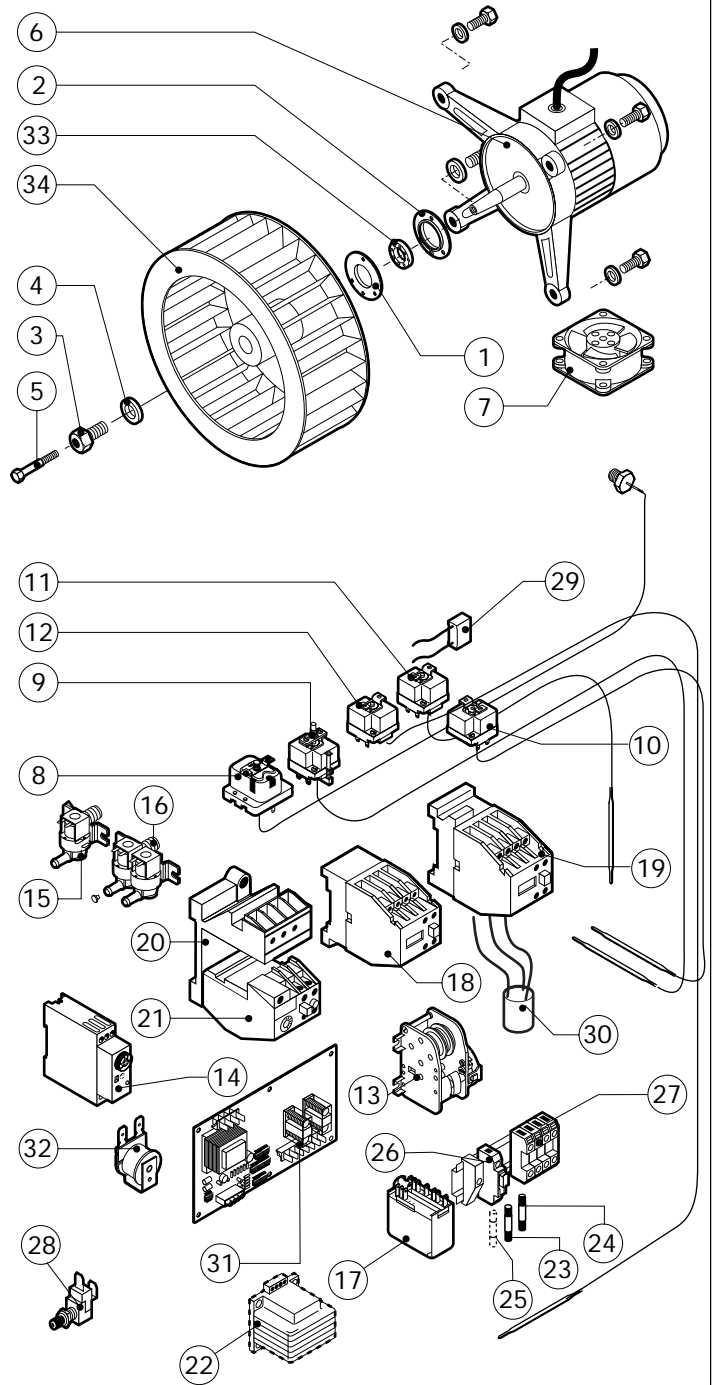
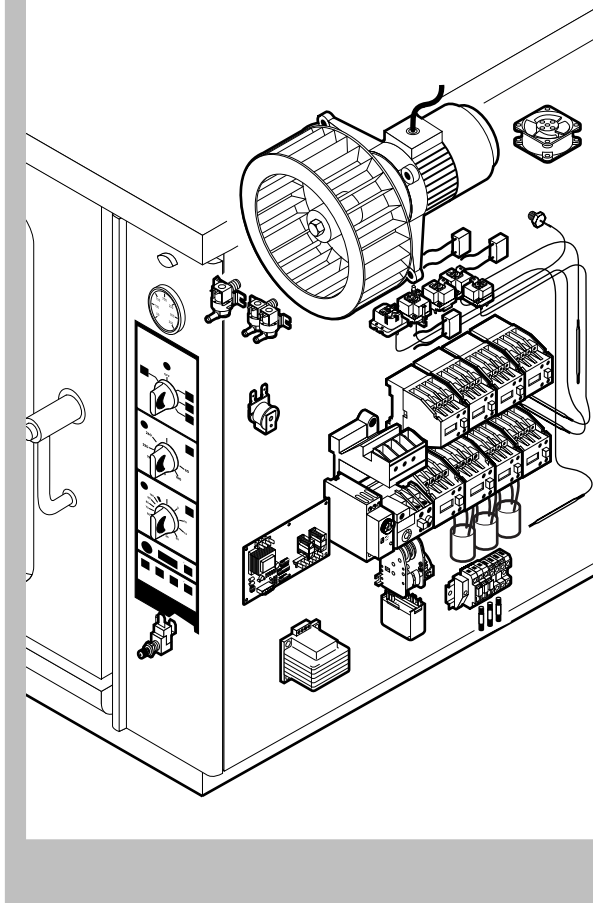

POS.	CODE	PIECES	DESCRIPTION
1	R58003840	1	MOTOR GASKET BRASS FLANGE
2	R58003850	1	MOTOR GASKET BRASS COUNTER FLANGE
3	R58004000	1	FAN SCREW M12x1.5 SX
4	R58004010	1	FAN WASHER Ø 30/12.5
5	R61020562	1	FAN SCREW TE A2 M6x55
6	R65040061	1	MOTOR HP 1 KIT
7	R65060050	1	COMPONENTS VENTILATION MOTOR Ø 120
8	R65070070	1	CHAMBER SAFETY THERMOSTAT
9	R65070080	1	STEAM GENERATOR SAFETY THERMOSTAT
10	R65070100	1	THERMOSTAT 55°C
11	R65070165	1	THERMOSTAT 65°C
12	R65070240	1	THERMOSTAT 70°C
13	R65090190	1	REVERSING SWITCH 8'
14	R65090450	1	S.GENERATOR DRAIN TIMER
15	R65110010	1	SOLENOID VALVE 220V 50HZ
16	R65115000	1	SOLENOID VALVE 220V 50HZ WITH FLOW REDUCER
17	R65120010	1	LEVEL REGULATOR
18	R65140150	5	CONTACTOR 3TF4011-OAUO 240V
19	R65140240	3	CONTACTOR 3TF4211-OAUO 240V

POS.	CODE	PIECES	DESCRIPTION
20	R65160050	1	THERMIC SWITCH SUPPORT 3UX1418
21	R65160120	1	THERMIC PROTECTION 3UA5000-1C 1.6-2.5A
22	R65180430	1	TRANSFORMER 40VA
23	R65200086	1	FUSE 0.125A (T)
24	R65200200	1	FUSE 2A
25	R65200350	1	FUSE 0.4A (T)
26	R65210020	3	FUSE CARRIER
27	R65220130	1	TERMINAL BOARD
28	R65260540	1	DOOR SWITCH
29	R65280130	3	INTERFERENCE SUPPRESSOR
30	R65280200	3	INTERFERENCE SUPPRESSOR
31	R65300490	1	RELAYS P.C. BOARD
32	R65330010	1	BUZZER
33	R70020050	1	MOTOR GASKET
34	R75400380	1	FAN Ø 350x120/24 50HZ P.D. KIT

