

GW - GWD

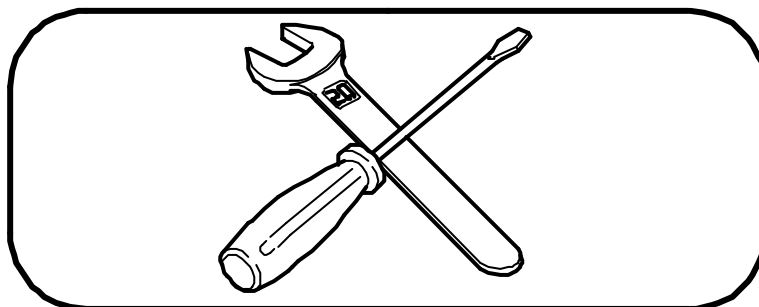

TAV.1

COD. UGELLO	DESCRIZIONE
1810093	UGELLO PILOTA D=0,25 GPL G30/31
1810094	UGELLO PILOTA D=0,45 METANO G20/25

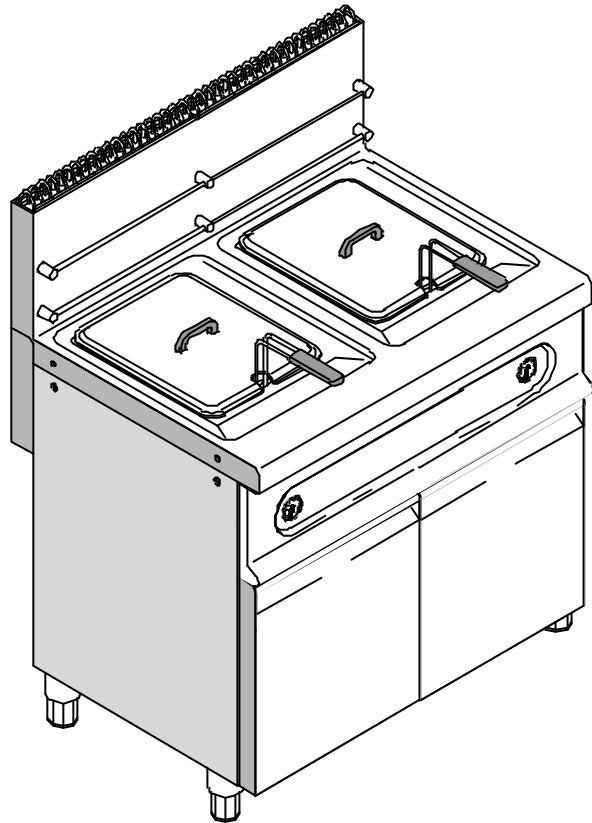
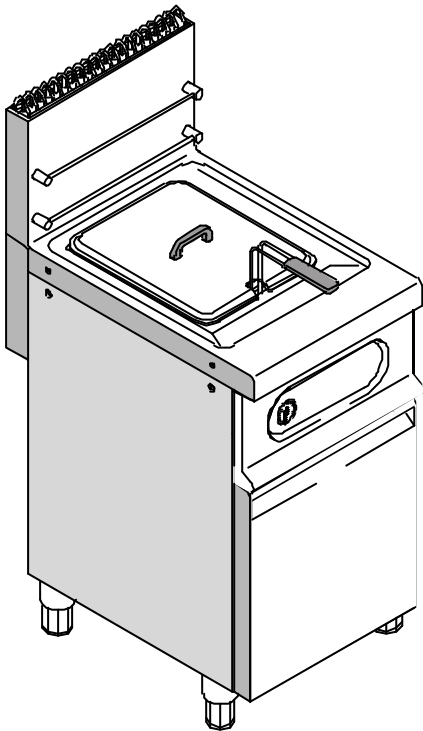
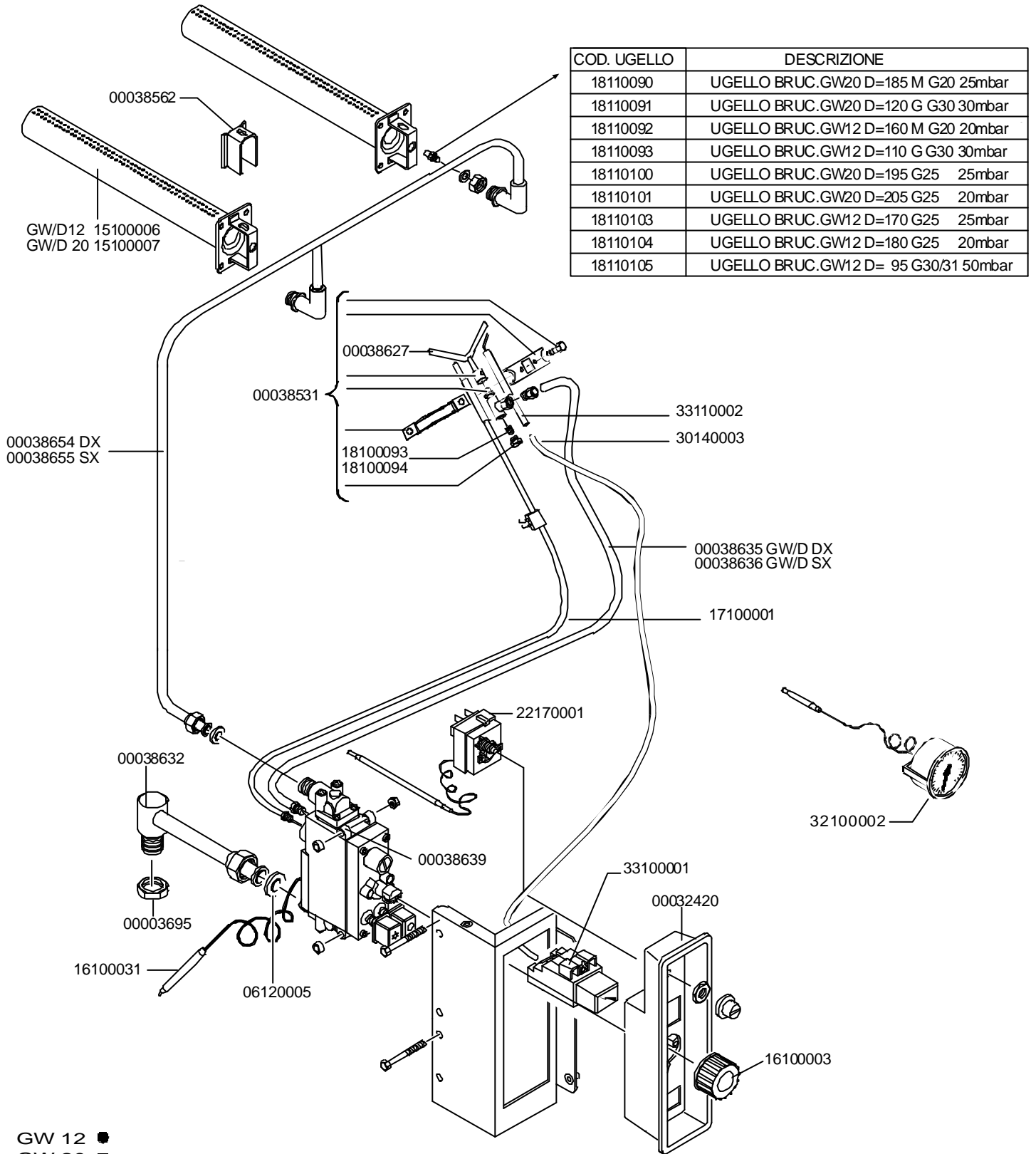

COD. UGELLO	DESCRIZIONE
18110090	UGELLO BRUC.GW20 D=185 M G20 25mbar
18110091	UGELLO BRUC.GW20 D=120 G G30 30mbar
18110092	UGELLO BRUC.GW12 D=160 M G20 20mbar
18110093	UGELLO BRUC.GW12 D=110 G G30 30mbar
18110100	UGELLO BRUC.GW20 D=195 G25 25mbar
18110101	UGELLO BRUC.GW20 D=205 G25 20mbar
18110103	UGELLO BRUC.GW12 D=170 G25 25mbar
18110104	UGELLO BRUC.GW12 D=180 G25 20mbar
18110105	UGELLO BRUC.GW12 D= 95 G30/31 50mbar

GW 12 ●
GW 20 ■

02/04

●	2	3	4	5	6	7	8	9	10	11	12	13	14	15
---	---	---	---	---	---	---	---	---	----	----	----	----	----	----

TAV. 2

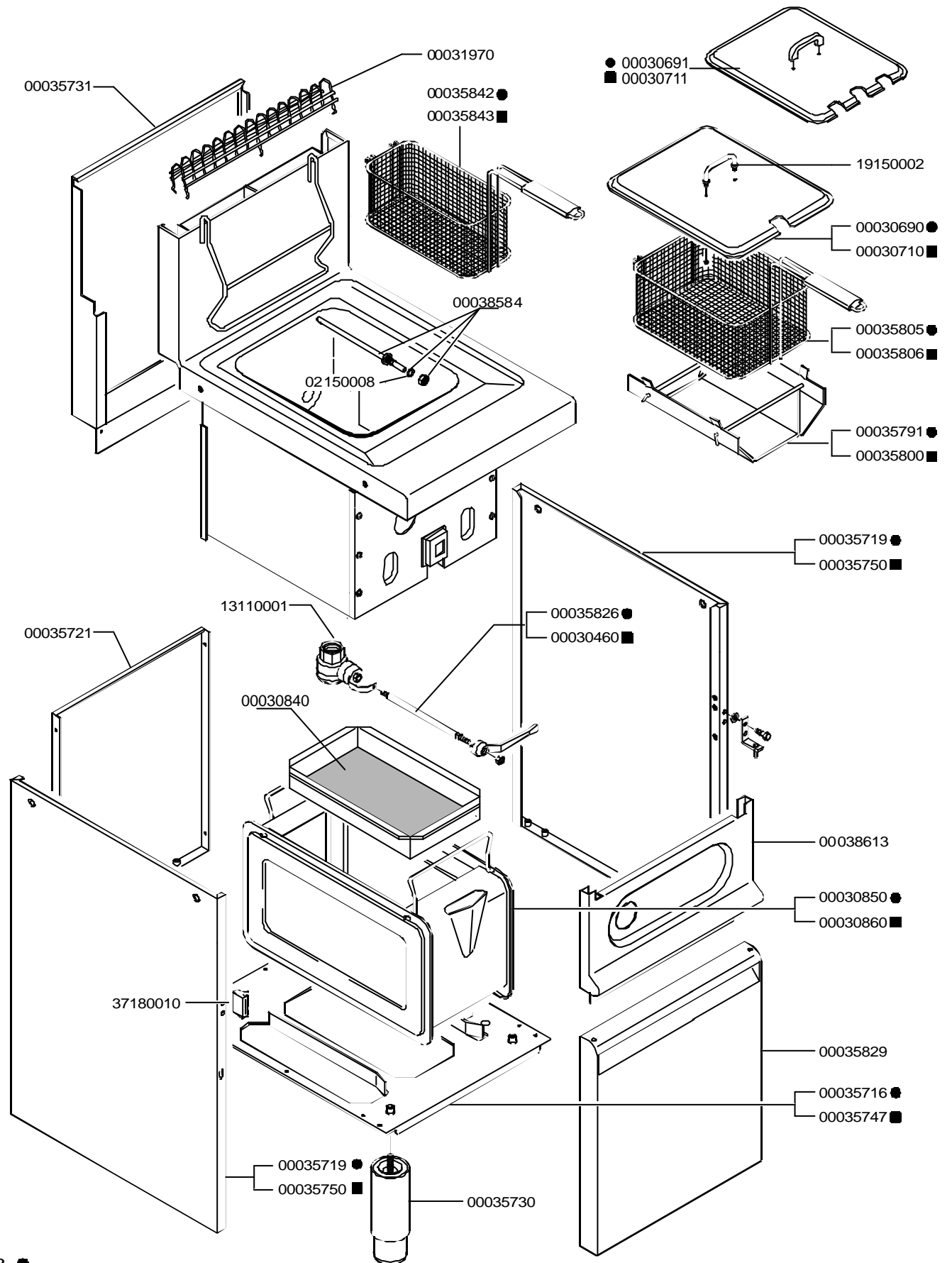

GW 12 ●
GW 20 ■

TAV. 3

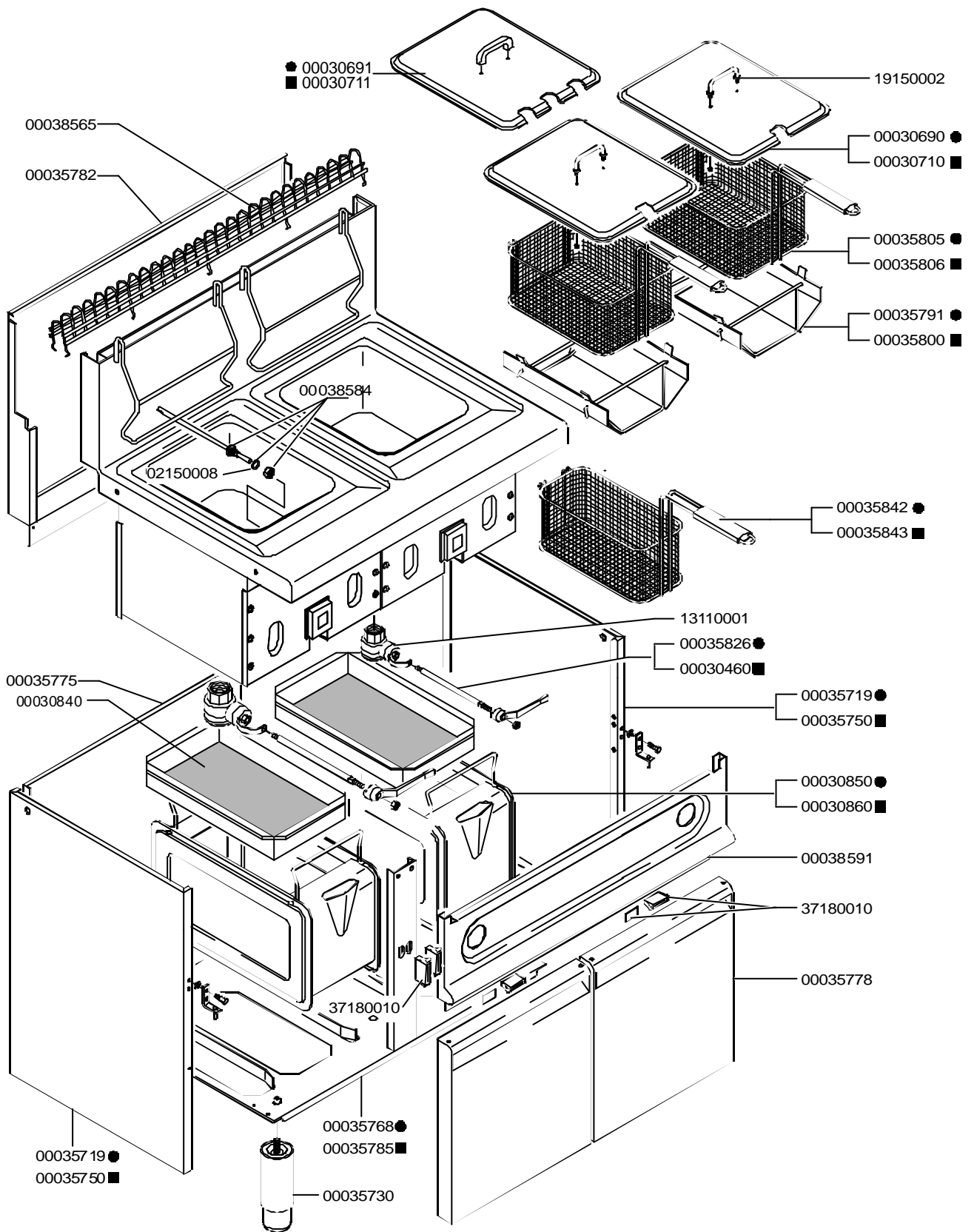

GWD 12 ●
GWD 20 ■

02/04

●	2	3	4	5	6	7	8	9	10	11	12	13	14	15
---	---	---	---	---	---	---	---	---	----	----	----	----	----	----