

Ricambi alternativi / Alternative spare parts		
Codice/Code	Descrizione/Description	In caso di / in case of
C2902-00	MOTORE 1020 0,37 KW 2-4P 400 V TRIF. 50/60 Hz	doppia velocità / double speed motor

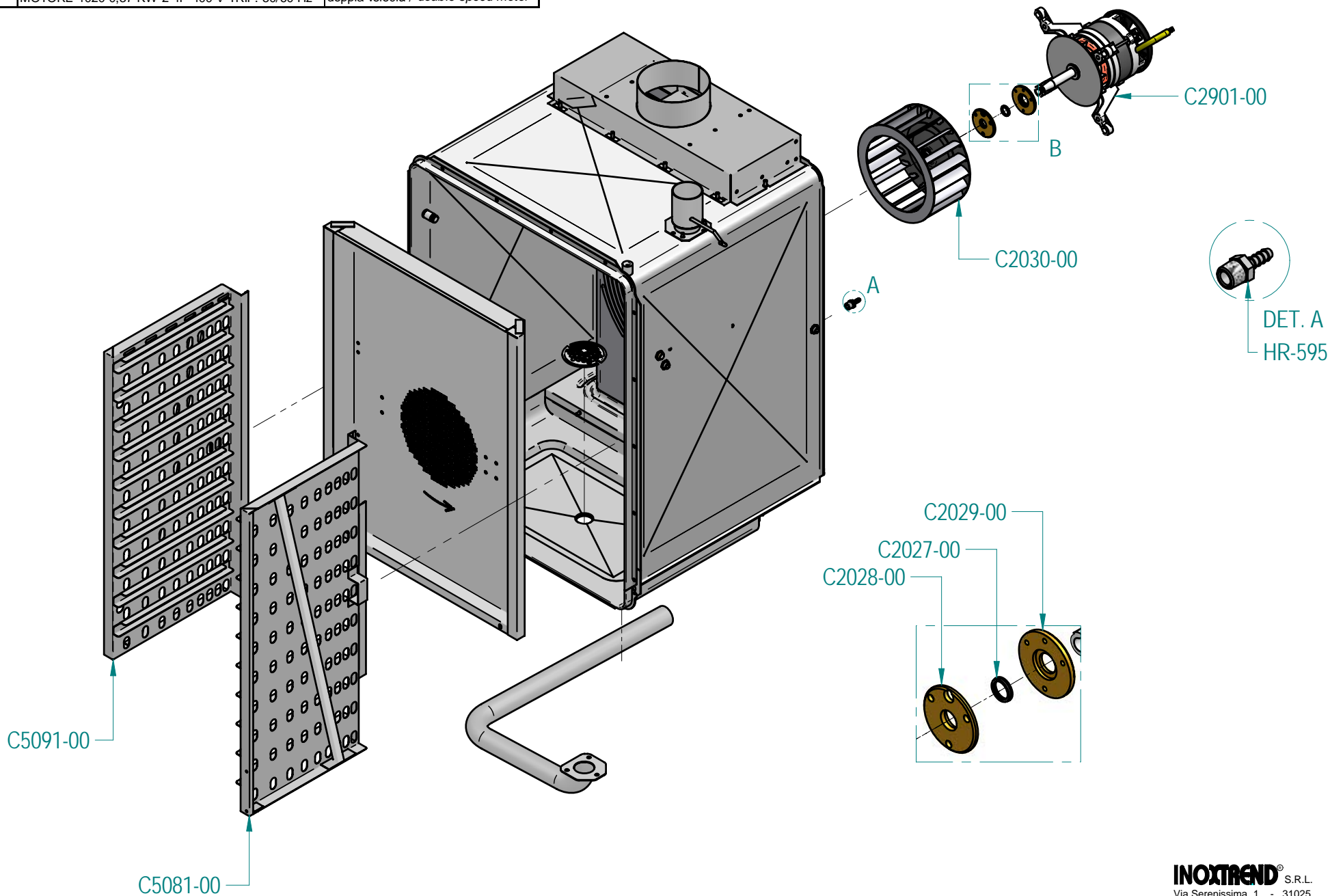

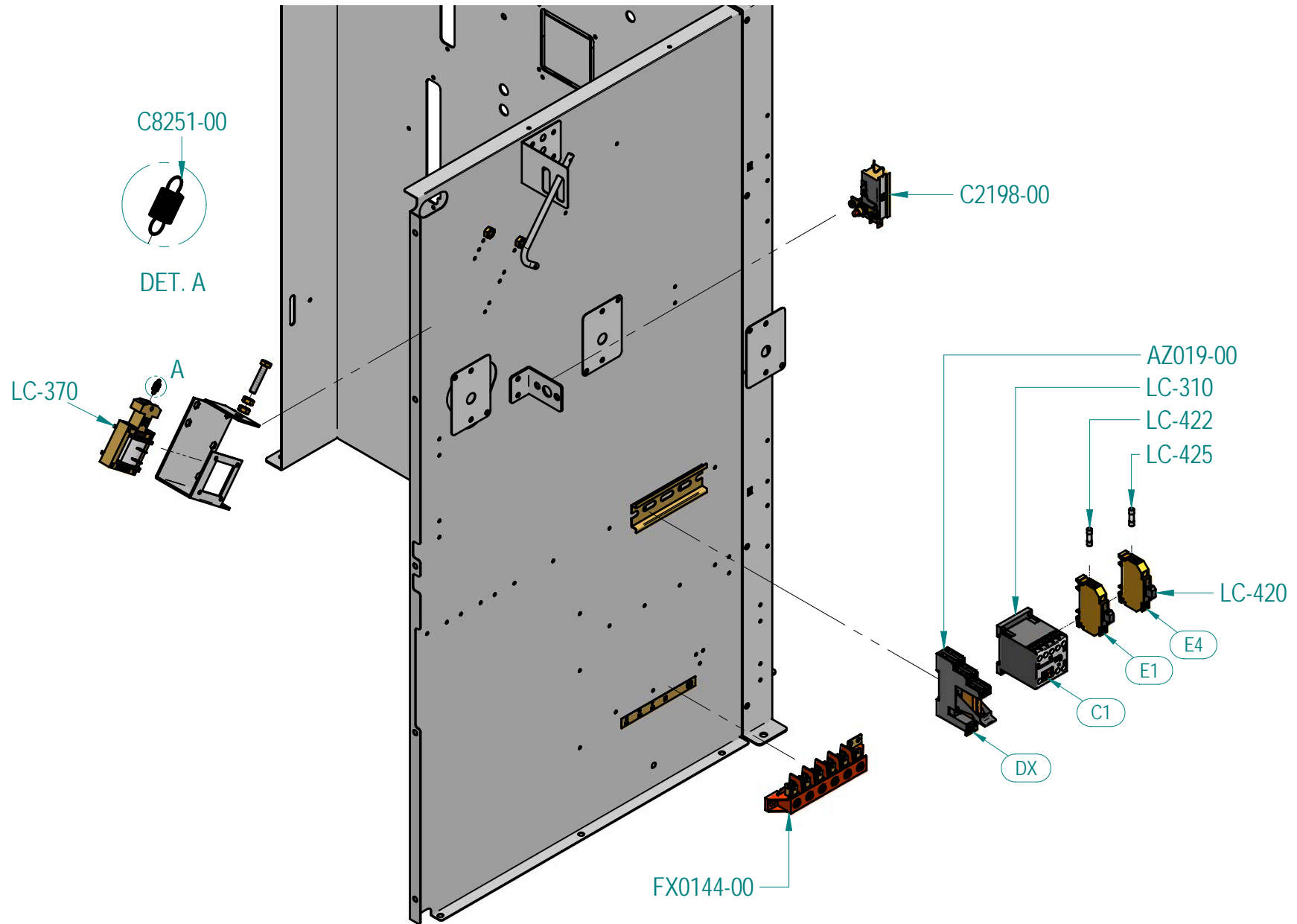

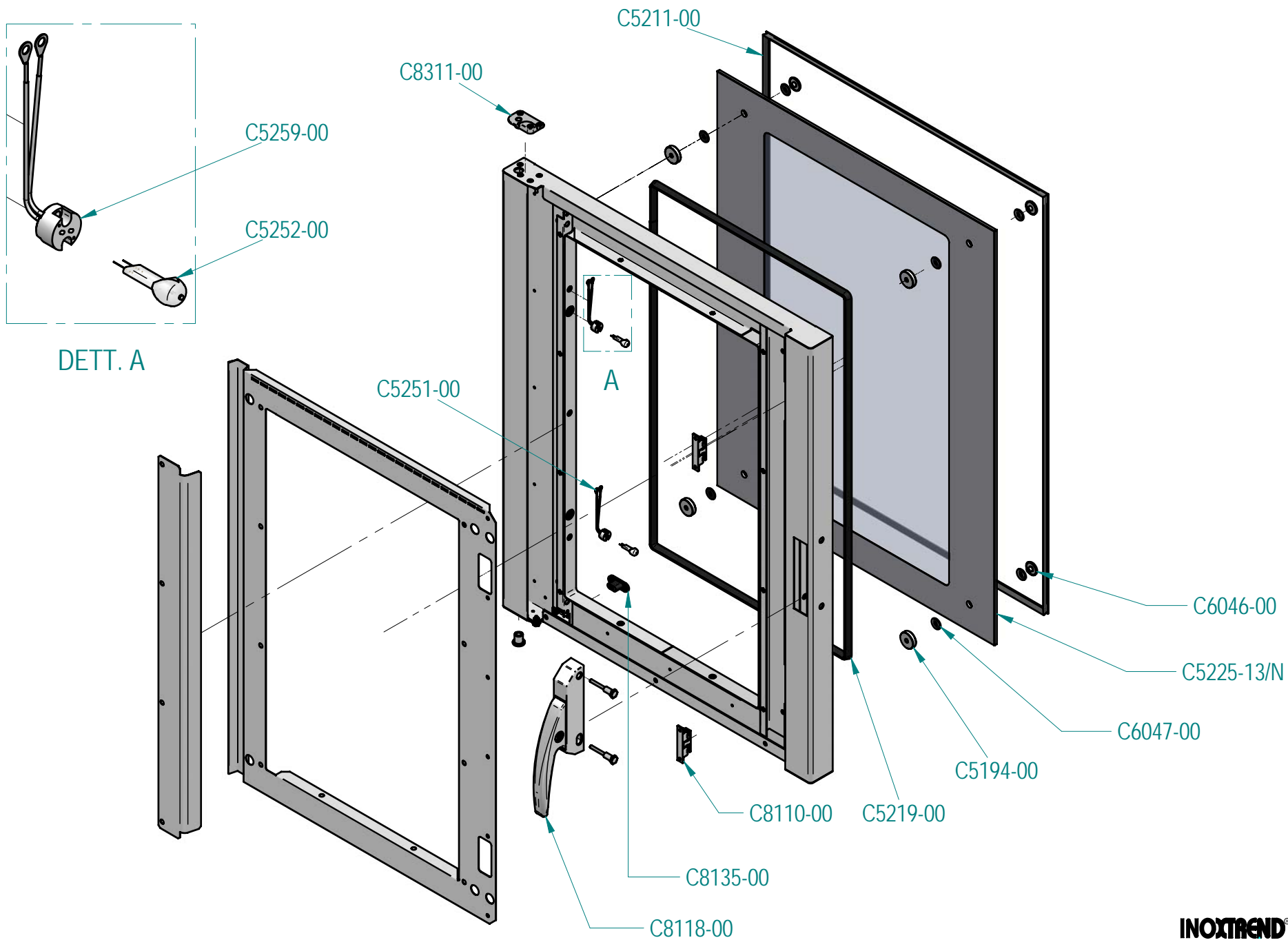

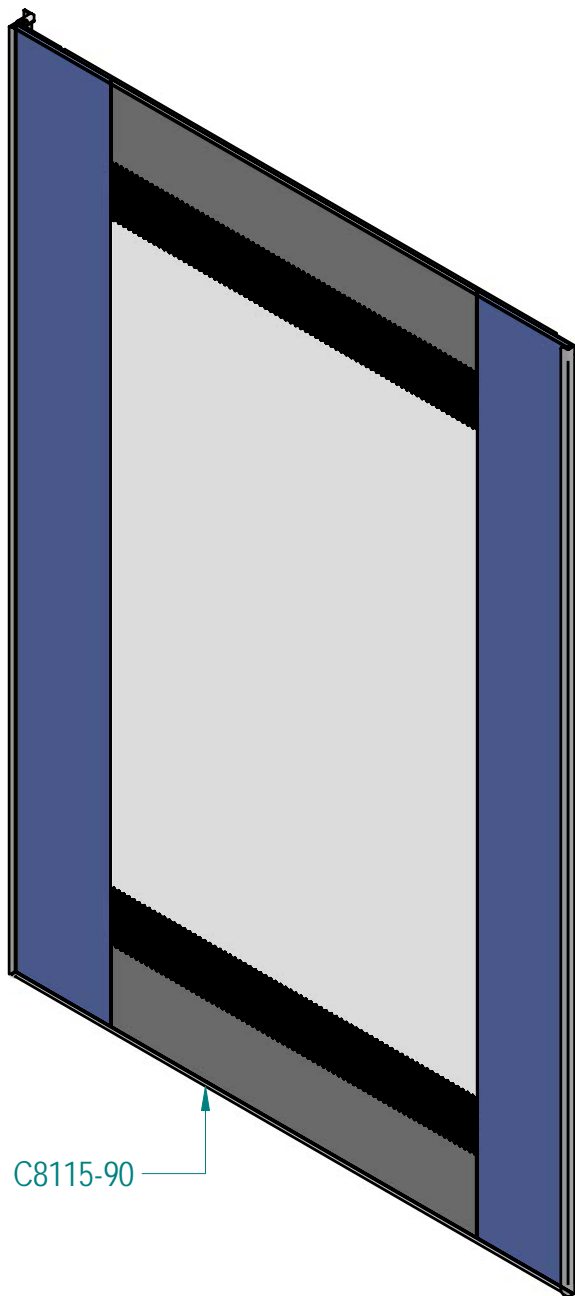

C8115-90

