

EN · ARP · AL · AG60 · AS · RIL

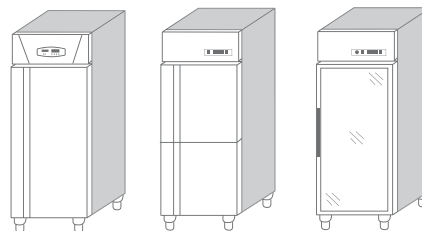

IT

ARMADI EURONORM
per pasticceria

GB

EURONORM CABINETS
for pastry

DE

SCHRÄNKE EURONORM
für Gebäck

FR

ARMOIRES EURONORM
pour pâtisserie

ES

GABINETES EURONORM
para pasteleria

PT

GABINETES EURONORM
para pasteleria

GR

ΕΡΜΑΡΙΑ EURONORM
ζαχαροπλαστικής

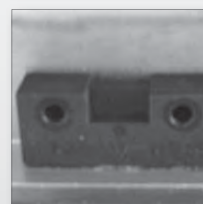

ESB0111EJ



AS



GOLD

CR

pag.6



G1

G1+G2



G2

BF

FRI

FRE



MAS

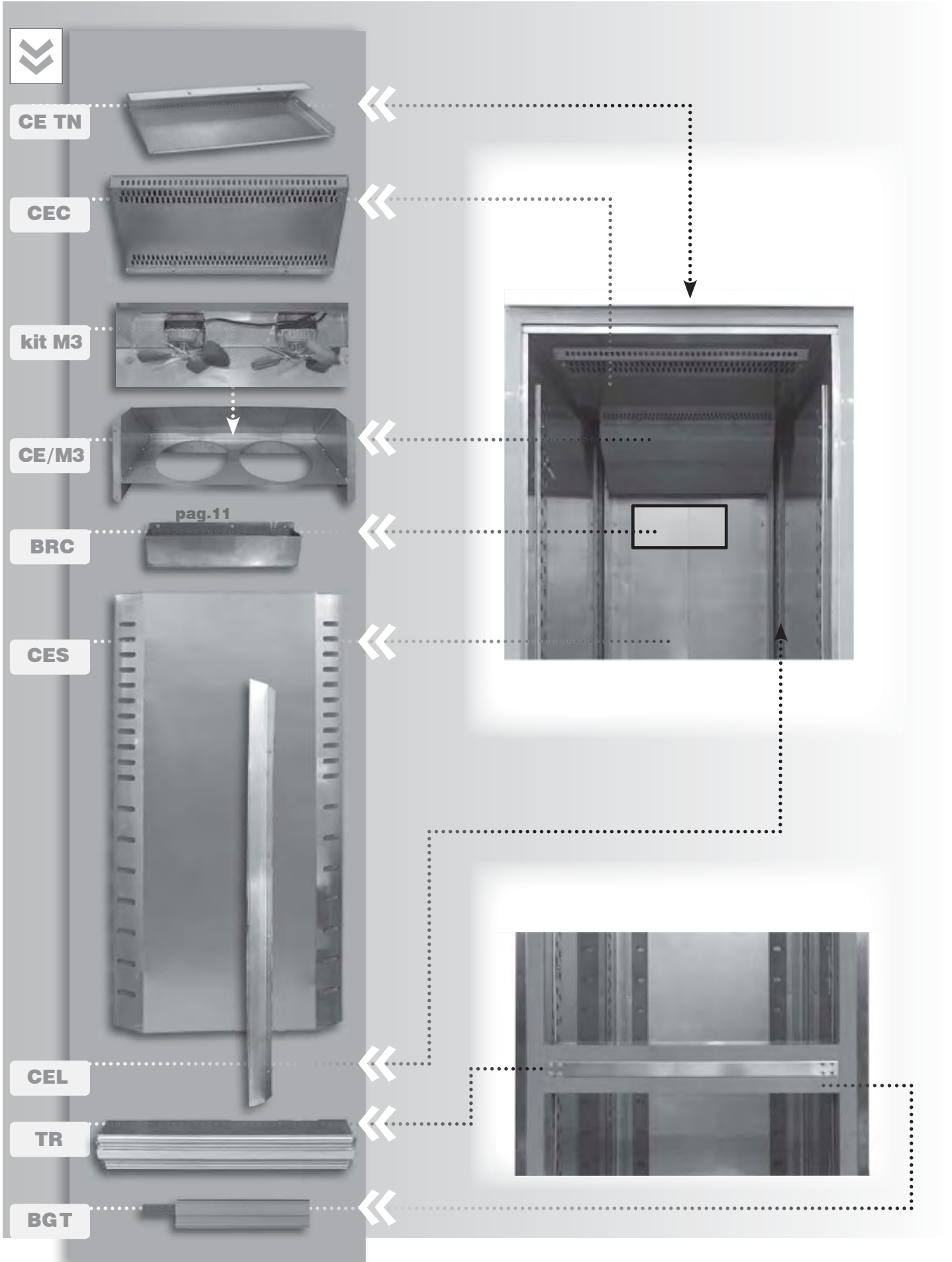

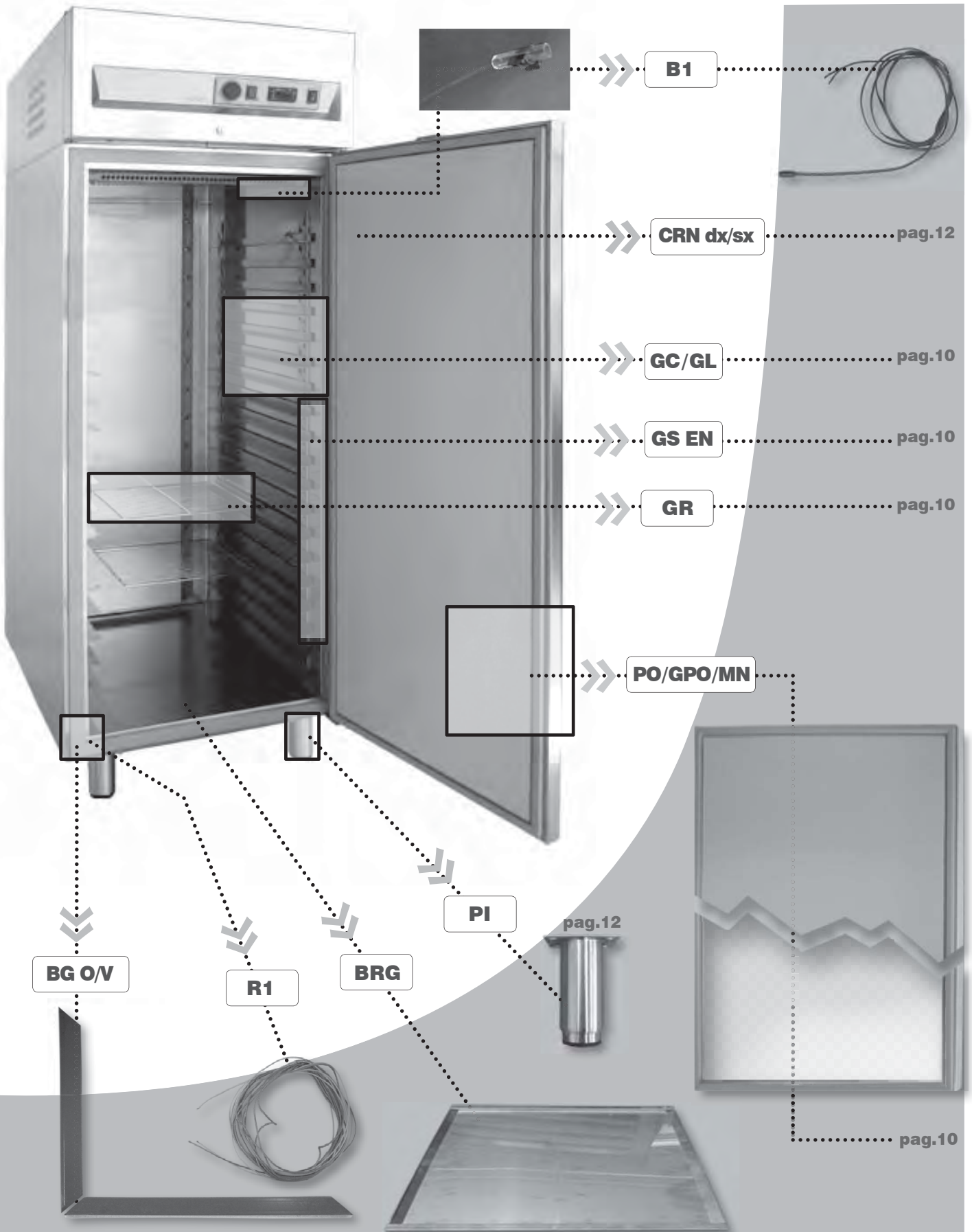

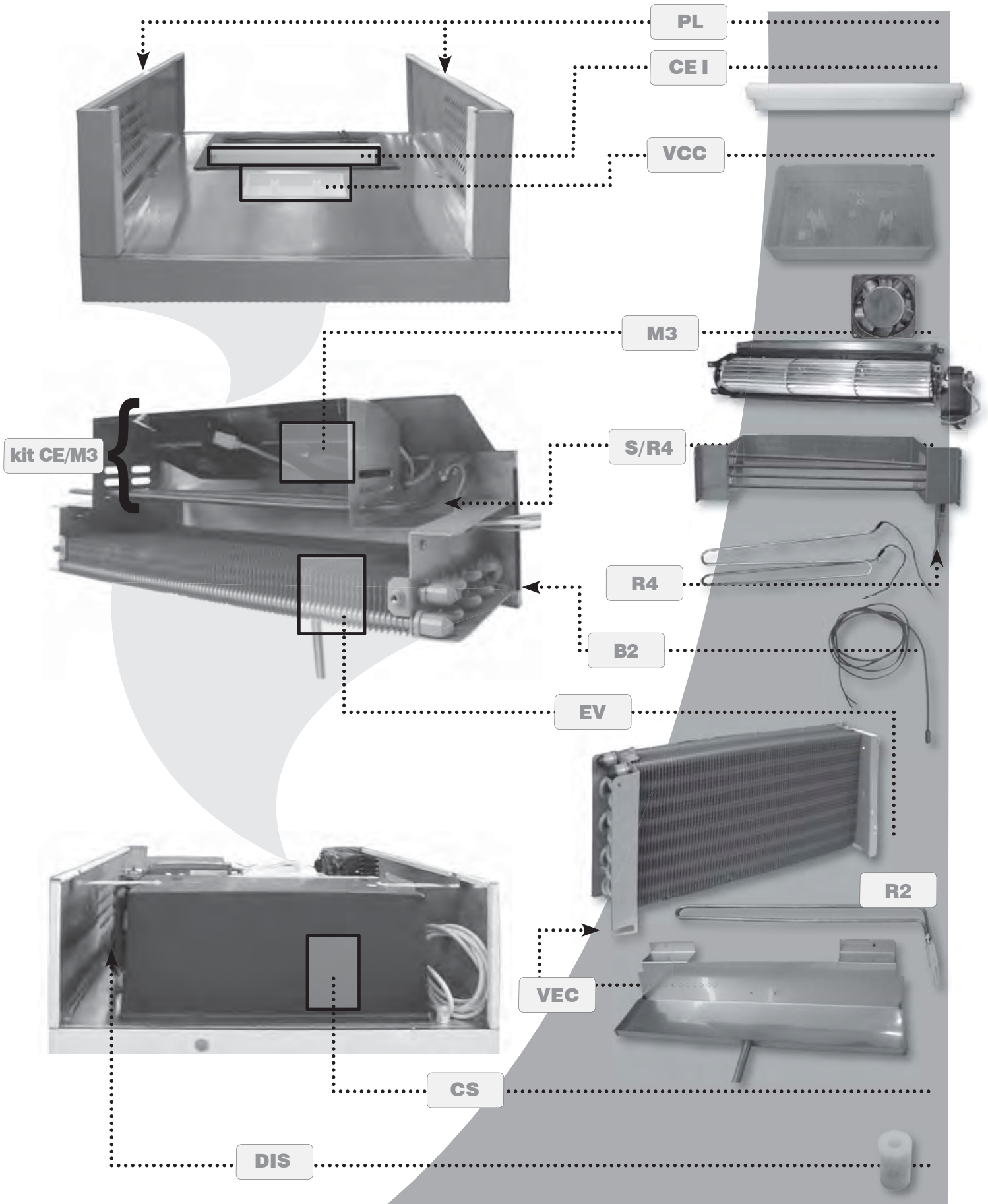

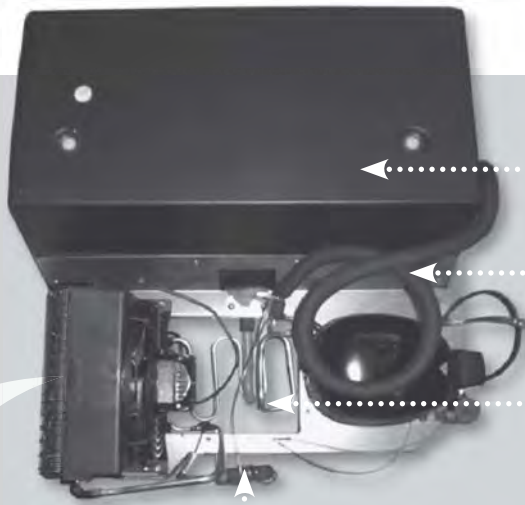

CS

TS

TEC

F

kit M2

M1

BOX/M1

Q

C/M1

BV+V1

VE

OR

BVE

PVE

F

RL

GPV

M4

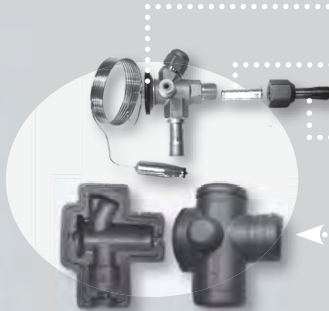

SCE pag.6

SCE/C

CRN CR pag.12

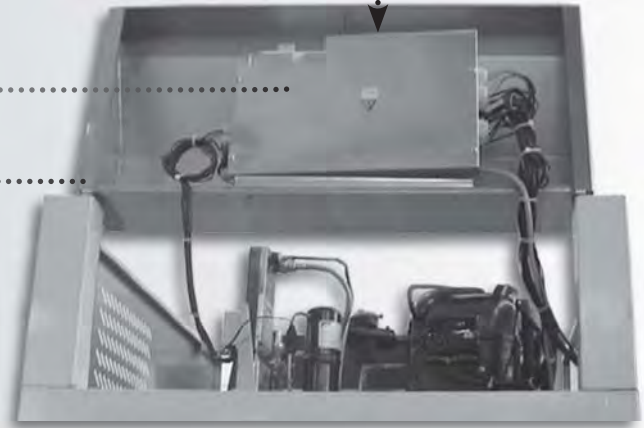

kit CO H2O

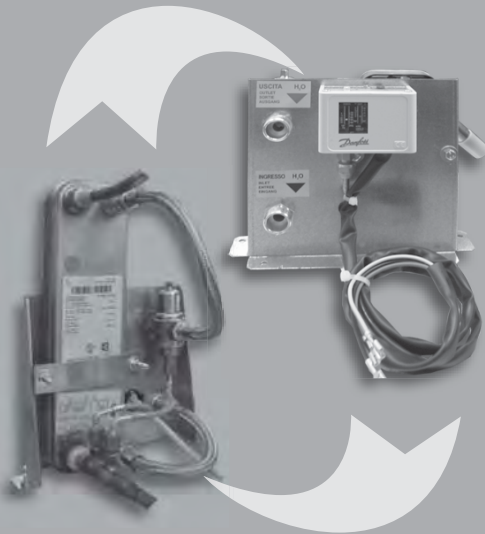

CO H2O

VP

TG

P

M2

GPV



pag.10

I3



PC G

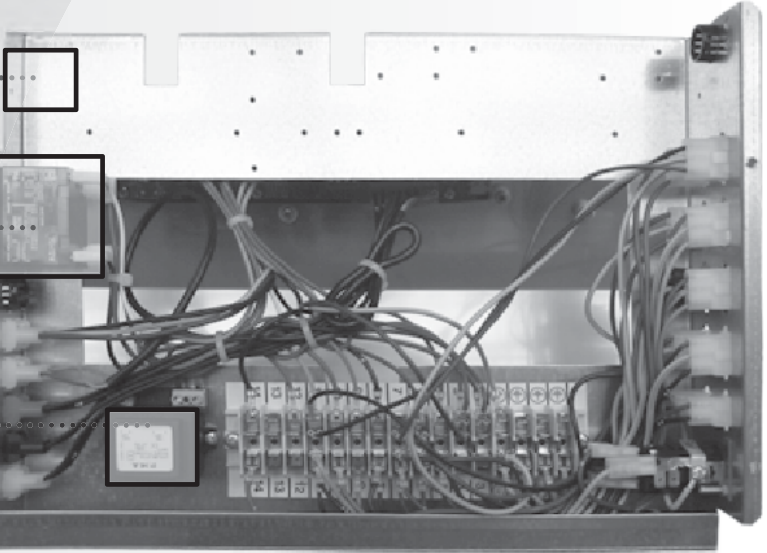

Q1



T



SCE



Q1

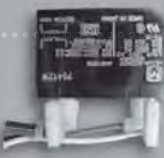

G2

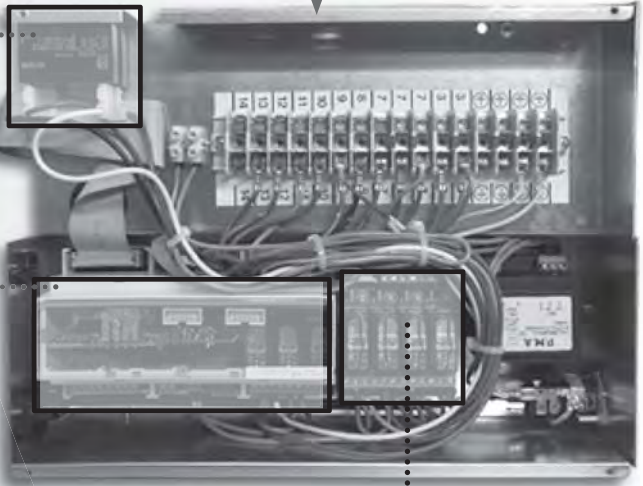

G1



G3



CV/E

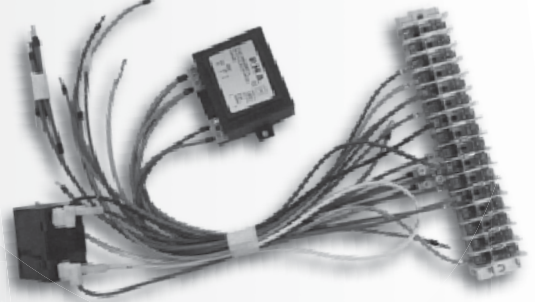

AL-RIL

A



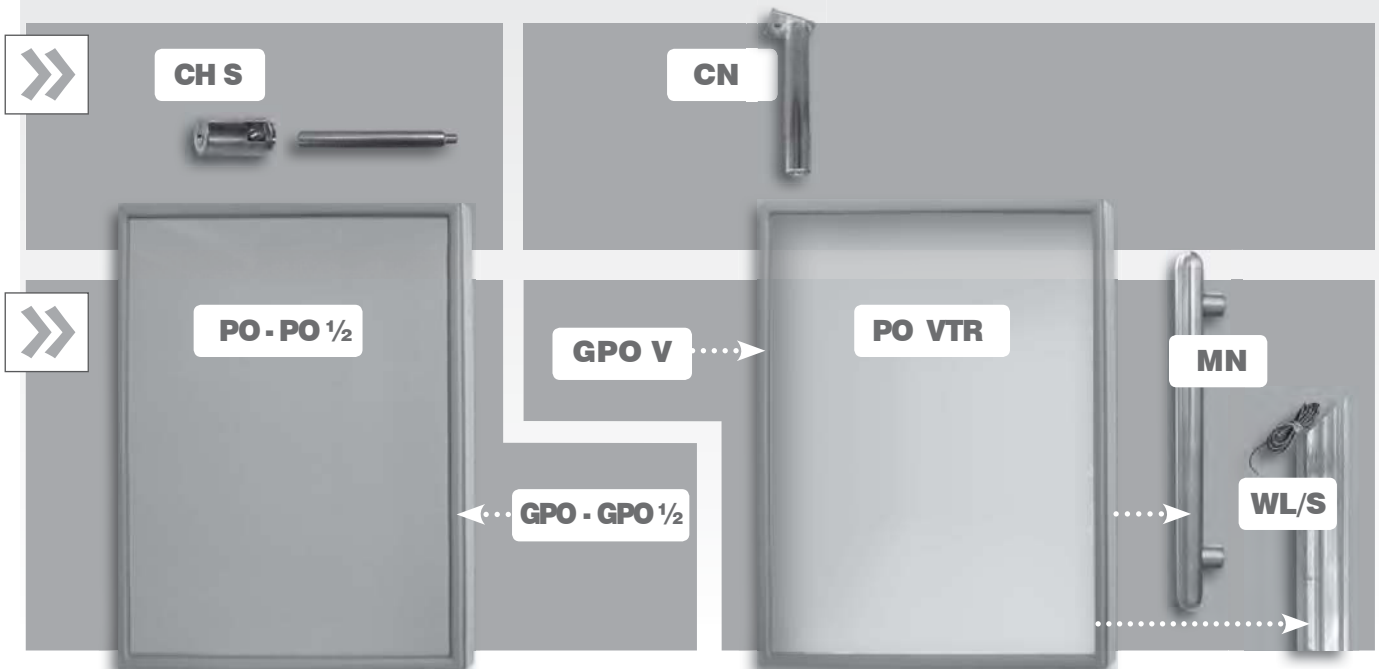
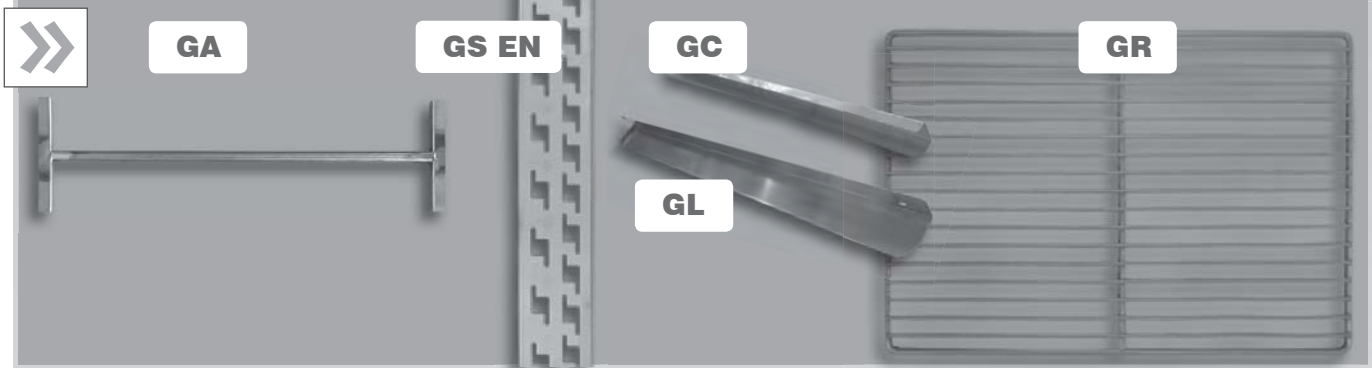



R3

CIA

B6

LL

VCC1

R3



AL-AS-RIL



R4

TSC

R6

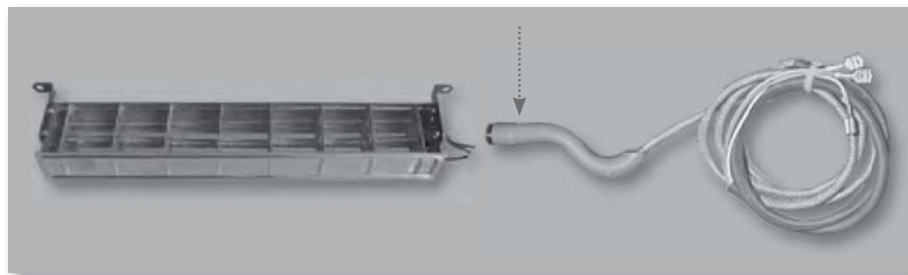

S

W

T2



FA

GA

CM1

CM2

CM3

CM4

CM5

XB

BO3

BO1



CA

TAI



RP

E

O



CRN dx/sx

CRN1 dx/sx

CRN2 dx/sx

CRN 4

CRN3 dx/sx

CRN1 dx/sx

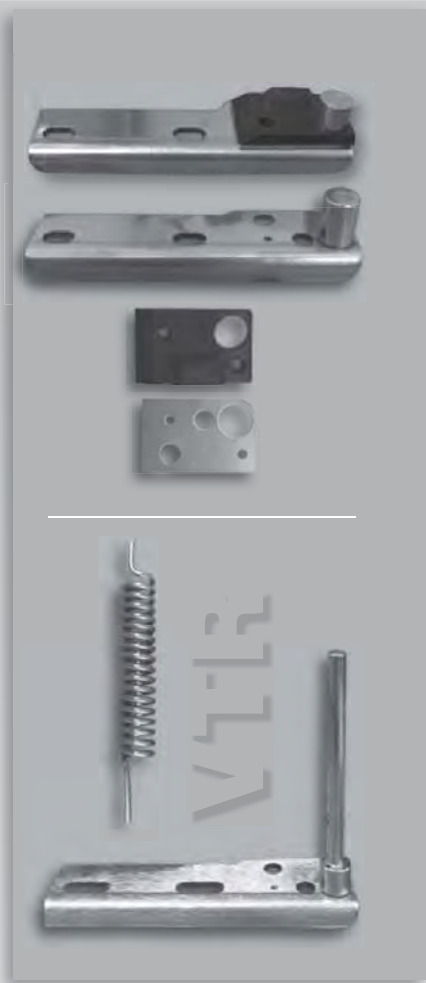

CRNS dx/sx

CRN1 dx/sx

CRN3 dx/sx

CRNS

BO/PO



PI 1

PI 2

PI 4



PRR 3

PRR 4



CRN 1/2 dx/sx

CRN3 dx/sx

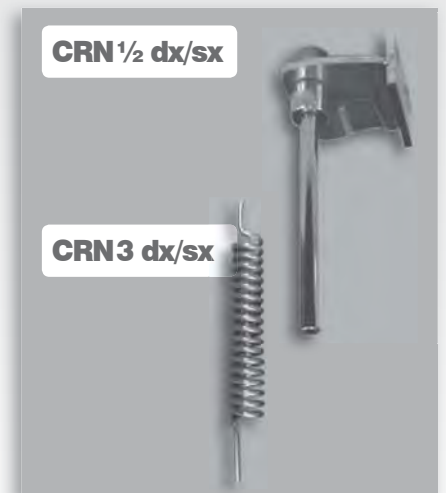

CRN CR



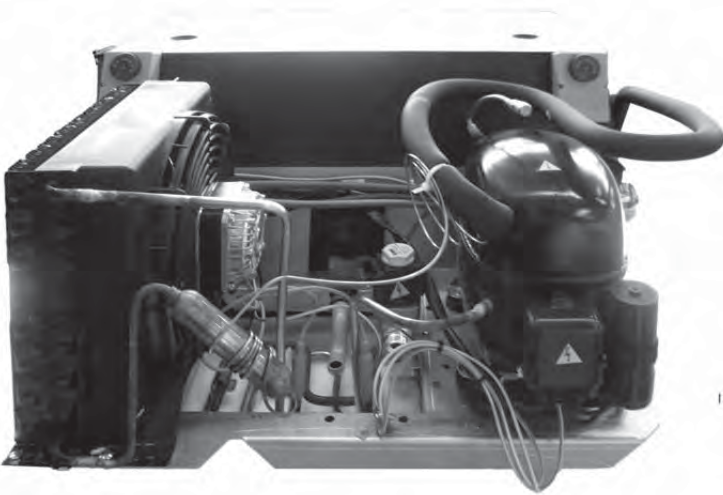
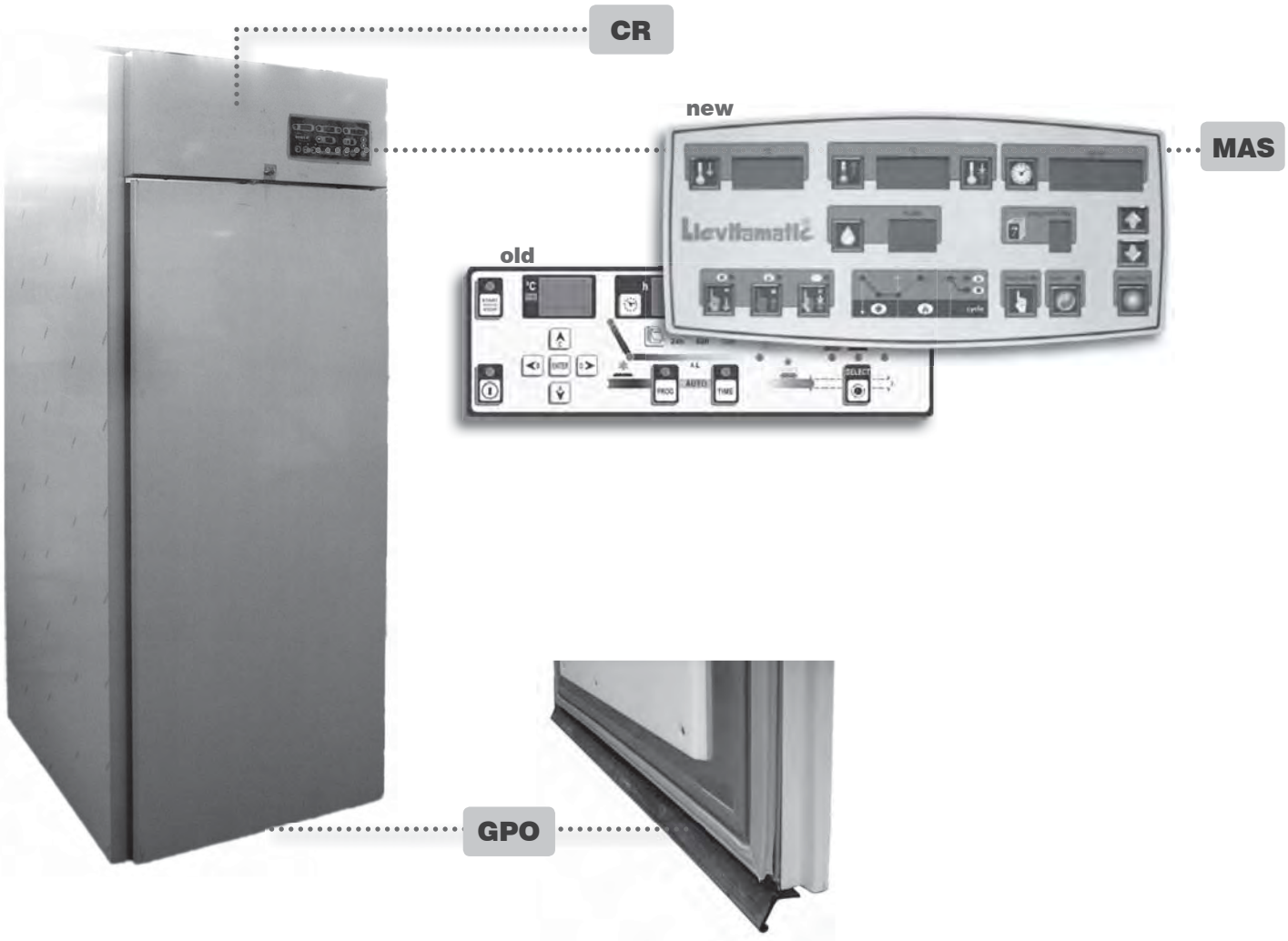

pag.7

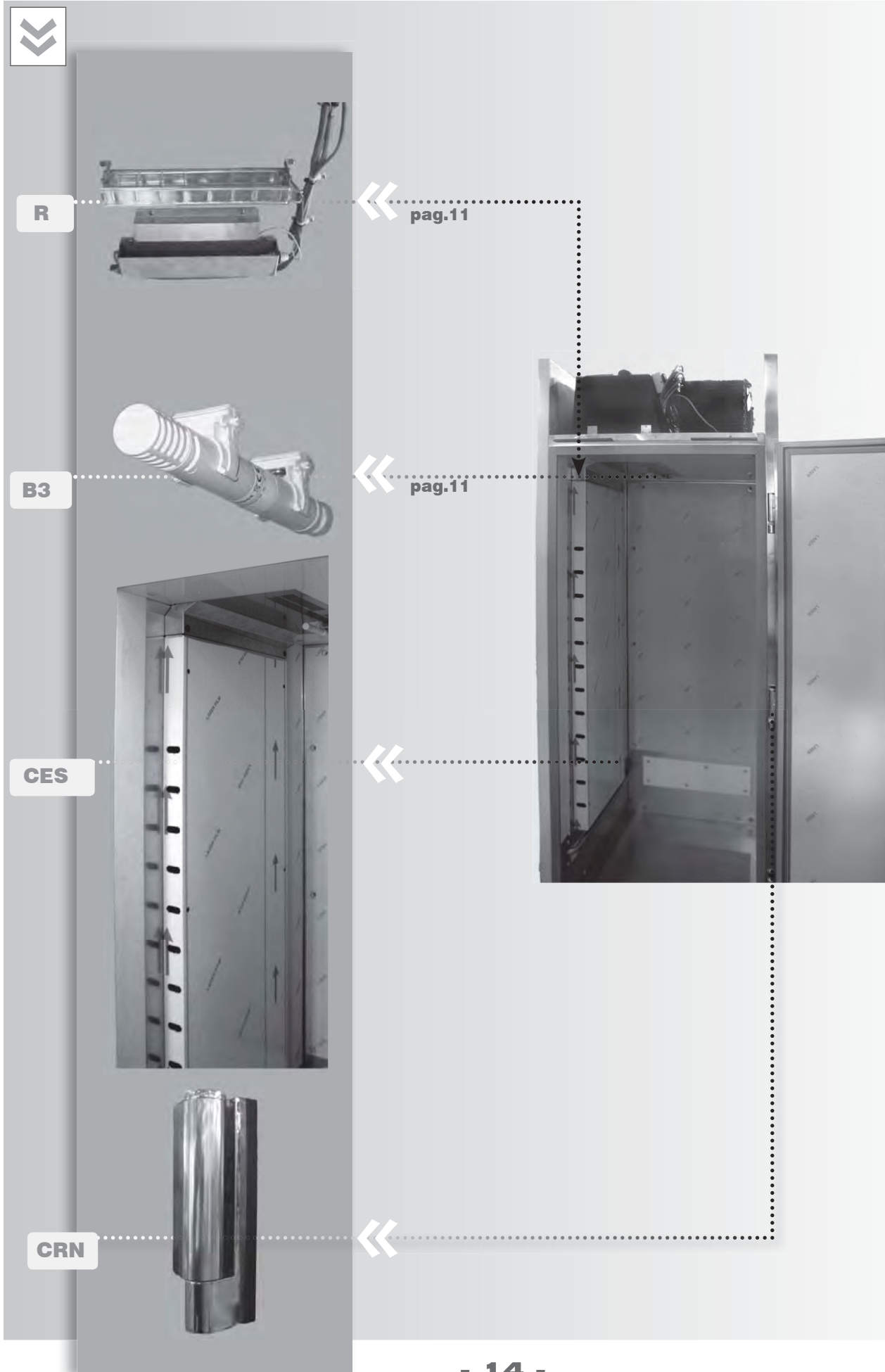

riferim. reference	codice code	descrizione description	modello model	da...a from...to	ricambi cons. rec. spare part
A	996901	ALIMENTATORE 220-240V AC 24V DC 30W POWER SUPPLY UNIT 220-240V AC 24V DC 30W	AS_VTR	06/10/09 00/00/00	
AG	990031	ASTA GANCIERA MOBILE AR L530 INOX SLADING HANGING RAIL SEAS. CAB. L530 INOX	AS	01/01/95 00/00/00	
B1	995562	SONDA PTC GRIGIA SILICONATA L=2500 CELLA PTC PROBE, GREY SILICONED L=2500 CABINET	AL	01/01/95 00/00/00	●
B2	995500	SONDA PTC ROSSA SILICONATA L=2500 EVAP. PTC PROBE, RED SILICONED L=2500 EVAPOR.	AL	01/01/95 00/00/00	●
B1 / B2	935886	SONDA NTC CAVOTPE SN691150 L=2,5+TER.F NTC CAVOTPE PROBE SN691150 L=2,5+TER.F	EN GOLD ● ARP ● AG60 GOLD ● AS	22/11/04 00/00/00	●
B6	935187	SONDA UMIDITA' EVHP503 STAGIONATORE HUMIDITY PROBE EVHP503 SEASONER CABINET	ARP ● AL ● AS	05/02/09 00/00/00	●
BF	936051	BICCHIERINO DI FISSAGGIO FRONT.IRIDIUM RUBBER FIXING IRIIDIUM FRONTAL PANEL	EN GOLD ● ARP ● AG60 GOLD ● AS	//_/_ 00/00/00	
BG O	996463	PROF.MOB.L=712 ORIZ.BAT.GUARN.AR EN HOR. EXT.PROFILE FOR RABBET L=712 EN CAB.	EN ● AG60 ● AS	01/01/95 12/11/08	
	935034	BATTUTA GUARNIZIONE ORIZ. L=687 C/MAGN. HORIZONTAL PROF. FOR RABBET L=687 + MAGN.		13/11/08 00/00/00	
BG T	936001	PROFILO L=644 ORIZZ.BATT.GUARN.EN HOR. EXT.PROFILE FOR RABBET L=644 EN CAB.	EN ● AG60	01/12/99 06/10/08	
	935035	BATT. GUARNIZ. TRAVERSA AR EN NEW L=621 PR. FOR CROS.PANEL RABBET L=621 EN NEW RC		07/10/08 00/00/00	
BG V	936000	PROFILO L=1575 VERT.BATT.GUARN.P.1/2 VERT. EXT. PROF. FOR RABBET L=1575 1/2 DOOR	EN ● AG60	01/01/95 13/11/08	
	935036	BATTUTA GUARNIZIONE VERT. L=1542 C/MAG. VERT.EXT.PROF. FOR RABBET L=1542 P0607 1/2D.		14/11/08 00/00/00	
BG V	996464	PROF.MOB.L=1575 VERT.BATT.GUA.AR EN VERT. EXT. PROF. FOR RABBET L=1575 EN CAB.	EN ● AS	01/01/95 12/11/08	
	935036	AB07 PROF.COPBATT.GU.L=1542 P0607 C/MA VERT.EXT.PROF. FOR RABBET L=1542 P0607 C/M		13/11/08 00/00/00	
BO 1	936038	BOCCOLA PASSACAPO D=08 BUSH D=08	EN ● AG60 ● AS	//_/_ 00/00/00	
BO 3	936038	BOCCOLA PASSACAPO D=14 BUSH D=14	EN2 ● AG60 ● AS	//_/_ 00/00/00	
BO/PO	935976	BOCCOLA PORTA VETRO STAR-EN-PLANET DOOR BUSH STAR-EN-PLANET	EN_VTR	//_/_ 00/00/00	
BOX/M1	996025	BOX ELETTRICO DANFOSS '117-7012' ELECTRIC BOX DANFOSS '117-7012'	> 995770	22/05/00 00/00/00	
BRG	935188	BACINELLA GOCCIOLATOIO AR STAGIONATORE DRIPPING TRAY FOR SEASONER CABINET	AS	05/02/09 00/00/00	
BV	996182	BOBINA HM2 230V 50/60HZ X VALVOLA SOLE COIL HM2 230V 50/60HZ FOR SOLENOID VALVE	AL ● AG60 G/CALDO ● AS	16/03/04 00/00/00	
BVE	996539	ADATTATORE VALV.ODF 6MM 68-2063 DANFOS VALVE ADAPETER ODF 6MM 68-2063 DANFOS	-P	13/07/05 00/00/00	
C/M1	996749	CONDENSATORE EL.DANFOSS '117U5012' ELECTRIC CONDENSER DANFOSS '117U5012'	> 995746	11/06/08 00/00/00	
C/M1	996023	CONDENSATORE EL. DANFOSS '117U5015' ELECTRIC CONDENSER DANFOSS '117U5015'	> 996353 > 995742	01/06/07 00/00/00	
C/M1	996024	CONDENSATORE EL. DANFOSS '117U5017' ELECTRIC CONDENSER DANFOSS '117U5017'	> 996725 > 995983 > 995743 > 995747	11/06/08 00/00/00	
C/M1	996550	CONDENSATORE EL. DANFOSS '117U5018' ELECTRIC CONDENSER DANFOSS '117U5018'	> 996354 > 996355	01/06/07 00/00/00	
CA	995420	CAVO ALIMENTAZIONE AR-TR SCHUCO ELECTRIC SUPPLY CABLE AR-TR SCHUCO	EN ● AG60 ● AS	29/05/03 00/00/00	
CE I	936031	PROF.ISO.31X30X560 ANTER.SUPP.VASCH.EV INSUL. PROF. 31X30X560 TO SUPP. EVAP. TRAY	EN ● AG60 ● AS	13/09/00 00/00/00	
CE TN	936028	TRAVERSA DIVISORIA PER CIELO AR EN PARTITION CROSS FRAME FOR CEILING EN CAB.	EN ● AG60 ● AS	//_/_ 00/00/00	
CE TN	936052	TRAVERSA DIVISORIA AREN CROSSBEAN HALF DOOR AR EN	AF-EN2_SUPER SILVER	16/02/01 00/00/00	
CE/M2	995759	CONVOGLIATORE CONDENS. STVF 124/194 CONDENSER CONVEYOR STVF 124/194	> 995523	08/04/03 00/00/00	
CE/M2	995775	CONVOGLIATORE CONDENS. STVF 93/139 CONDENSER CONVEYOR STVF 93/139	> 995522 > 995524	08/04/03 00/00/00	
CE/M2	996162	CONVOGLIATORE CF33 COND.LUVE STVF273 CONVEYOR CF33 COND. LUVE STVF273	> 995908	08/04/03 00/00/00	
CE/M3	935632	ASS.CONVOGLIATORE VENT.AR EN SUPER FAN CONVEYOR ASS. EN SUPER CABINETS	AF-EN2 SUPER ● AF-EN2_VTR ICE	16/02/01 00/00/00	

referim. reference	codice code	descrizione description	modello model	da...a from...to	ricambi cons. rec. spare part
CEC	935627	CONVOGLIATORE CIELO AR EN1 CEILING CONVEYOR EN2 CABINET	EN1	13/12/99 00/00/00	
CEC	935628	CONVOGLIATORE CIELO AR EN2 CEILING CONVEYOR EN2 CABINET	EN2 • AS	_/_/_ 00/00/00	
CEC	935631	CONVOGL. CIELO AR EN SUPER CEILING CONVEYOR EN SUPER CABINET	AF-EN2 SUPER	13/12/99 00/00/00	
CEC	936644	CONVOGLIATORE CIELO AR EN GELATO CEILING CONVEYOR EN ICE CABINET	AG60	20/05/08 00/00/00	
CEL	935637	SPALLA CONV. ARIA AR EN BACK SIDE CONVEYOR EN CABINETS	AF-EN2_SUPER SILVER	_/_/_ 00/00/00	
CES	935629	CONVOGLIATORE SCHIENALE AR EN BACK CONVEYOR EN CABINET	EN	10/01/00 00/00/00	
CES	936647	CONVOGLIATORE SCHIENALE AR EN GELATO BACK CONVEYOR EN ICE CABINET	AG60	20/05/08 00/00/00	
CES	935189	CONVOGL. SCHIENALE AR EN STAGIONATORE BACK CONVEYOR EN SEASONER CABINET	AS	05/02/09 00/00/00	
CH	925337	COPPIA CHIAVI PORTA TR GOLD 'INOX' PAIR OF KEYS FOR DOOR TR GOLD 'INOX'	EN • AG60 • AS	16/06/06 00/00/00	
CH CR	935400	SERRATURA A CHIAVE X AR MNSC/22 LOCKING DOOR KEY FOR MNSC/22 CABINETS	EN • AG60 • AS	01/01/95 00/00/00	
CH S	925807	SERRATURA A PALETTO + PERNO TR H=650 N SHAFT-TYPE LOCK. DOOR + PIN H=650 TR NEW	EN GOLD	08/11/04 00/00/00	
CIA	925694	CAPILL. XINIEZ. H2O D=1,24X150 INJECTION WATER CAPILLARY D=1,24X150	AL • AS	06/09/06 00/00/00	
CM1	936038	CONNETTORE MTL MASC. 2 POLI NERO EDGE CONNECTOR MTL 2 POLES BLACK	EN GOLD • ARP • AG60 GOLD • AS	23/06/04 00/00/00	
CM2	936037	CONNETTORE MTL MASC. 2 POLI BIANCO EDGE CONNECTOR MTL 2 POLES WHITE	EN GOLD • ARP • AG60 GOLD • AS	19/06/03 00/00/00	
CM3	936039	CONNETTORE MTL MASC. 2 POLI ROSSO EDGE CONNECTOR MTL 2 POLES RED	EN GOLD • ARP • AG60 GOLD • AS	19/11/04 00/00/00	
CM4	936040	CONNETTORE MTL MASC. 3 POLI NERO EDGE CONNECTOR MTL 3 POLES BLACK	EN GOLD • ARP • AG60 GOLD • AS	29/11/04 00/00/00	
CM5	936036	CONNETTORE MTL MASC. 3 POLI BIANCO EDGE CONNECTOR MTL 3 POLES WHITE	EN GOLD • ARP • AG60 GOLD • AS	29/11/04 00/00/00	
CN	935319	CANOTTO INOX AR MNSCOCCA PORTEVETRO INOX TUBE FOR MNCQ CABINETS GLASS-DOOR	EN_VTR • AS_VTR	28/11/02 00/00/00	
CN	935723	CANNOTTO IN PLASTICA SUP. DX UPPER RIGHT PLASTIC TUBE	EN • AG60 • AS	15/10/08 00/00/00	
CN	935724	CANNOTTO IN PLASTICA INF. DX UPPER LEFT PLASTIC TUBE	EN • AG60 • AS	15/10/08 00/00/00	
CO	995522	CONDENSATORE STVF 139 CONV RINF C/CURV STVF 139 CONDENSER	AF-EN1 • AL-EN1_SUPER • AR-EN2 • ARP-EN2 • AL-EN2 • AS	01/01/95 00/00/00	
CO	995523	CONDENSATORE STVF 194 CONV RINF C/CURV STVF 194 CONDENSER	AF-EN2 • AL-EN2 SUPER • AG60 GOLD	01/01/95 00/00/00	
CO	995524	CONDENSATORE STVF 93 CONV RINF C/CURV STVF 93 CONDENSER	AR-EN1 • ARP-EN1 • AL-EN1 • AG60 SILVER	01/01/95 00/00/00	
CO H2O	995909	CONDENSATORE H2O SALDOBR. ZC207 10 PIA WATER CONDENSER BRAZED ZC207 10 PLATES	EN_H2O • AG60 H2O	13/06/05 00/00/00	
CR	935648	ASS. CRUSCOTTO BT AR EN1/EN2 FRONTAL PANEL BT EN1/EN2 CABINETS	AF-EN SILVER	01/01/95 09/11/08	
	935066	ASS. CRUSCOTTO BT AR EN1/EN2 NEW FRONTAL PANEL BT EN1/EN2 NEW CABINETS		10/11/08 00/00/00	
CR	935651	ASS. CRUSCOTTO TN AR EN1/EN2 FRONTAL PANEL TN EN1/EN2 CABINETS	AR-EN SILVER	01/01/95 19/10/08	
	935068	ASS. CRUSCOTTO TN AR EN1/EN2 NEW FRONTAL PANEL TN EN1/EN2 NEW CABINETS		20/10/08 00/00/00	
CR	996363	ASS. CRUSCOTTO ARMADI EN VERS. IRIIDIUM FRONTAL PANEL EN CABINETS IRIIDIUM	AR-EN GOLD • AF-EN GOLD • ARP • AG60 GOLD • AS	01/01/95 12/11/08	
	935069	ASS. CRUSCOTTO AR EN VER. IRIIDIUM NEW FRONTAL PANEL EN CABINETS IRIIDIUM NEW		13/11/08 00/00/00	
CR	935678	ASS. CRUSCOTTO AR EN2 LIEVITAMATIC FRONTAL PANEL EN2 CABINET LIEVITAMATIC	AL	01/01/95 12/11/08	
	935070	ASS. CRUSCOTTO AR EN LIEVITAMATIC NEW FRONTAL PANEL EN CABINET LIEVITAMATIC NEW		13/11/08 03/04/11	
	615A591	ASS. CRUSC. AR EN LIEVIT. SCH. FL08 FRX NEW FR. PANEL EN LIEVITAM. CAB. FL08 CARD FRX		04/04/11 00/00/00	
CR	936653	ASS. CRUSCOTTO BT AR EN GELATO FRONTAL PANEL EN BT CABINET ICE	AG60 SILVER	20/05/08 00/00/00	

referim. reference	codice code	descrizione description	modello model	da...a from...to	ricambi cons. rec. spare part
CRN dx	935316	CERNIERA INFERIORE'DX'AR MNSC P/VET LOWER RIGHT HINGE AR MNSC GLASS DOOR	EN • AG60	01/01/95 00/00/00	
CRN sx	935317	CERNIERA INFERIORE'SX'AR MNSC P/VET LOWER LEFT HINGE AR MNSC GLASS DOOR	EN • AG60	01/01/95 00/00/00	
CRN1/2 dx	935644	ASS.CERNIERA 1/2 P DX AR EN RIGHT HINGE FOR HALF DOOR EN CABINETS	EN • AG60	01/12/99 31/12/07	
	935834	ASS.CERN.PORTA 1/2 DX AR STAR RIGHT HINGE FOR HALF DOOR STAR CABINETS		01/01/08 00/00/00	
CRN1/2 sx	935645	ASS.CERNIERA 1/2 P SX AR EN LEFT HINGE FOR HALF DOOR EN CABINETS	EN • AG60	01/12/99 31/12/07	
	935833	ASS.CERN.PORTA 1/2 SX AR STAR LEFT HINGE FOR HALF DOOR STAR CABINETS		01/01/08 00/00/00	
CRN 1	935316	CERNIERA INFERIORE DX AR MNSC P/VET LOWER RIGHT HINGE MNCQ CAB. GLASS DOOR	AG60	__ 00/00/00	
CRN 1 dx	936002	ASS.CERNIERA INF.DX PORTE VTR.AR/EN MN LOWER RIGHT HINGE ASS. GLASSES DOOR AR EN	EN	20/09/07 00/00/00	
CRN 1 sx	965663	ASS.CERNIERA INF.SX PORTE VTR.MNSC-AR LOWER LEFT HINGE ASS. GLASSES DOOR AR EN	EN • AG60	29/11/07 00/00/00	
CRN 1V dx	935975	STAFFA CERN.INFER DX AR VTR STAR-EN LOWER RIGHT HINGE GLASS DOOR STAR-EN C.	EN_VTR • AS_VTR	16/05/07 00/00/00	
CRN 1V sx	935981	STAFFA CERN.INFER SX AR VTR STAR-EN LOWER LEFT HINGE GLASSES DOOR STAR-EN C.	EN_VTR • AS_VTR	16/05/07 00/00/00	
CRN 2 dx	935715	PIASTRA FERMO PORTA 'DX'PV'AR MNSC RIGHT LOCKING DOOR PLATE 'PV'AR MNSC	EN • AG60 • AS	19/09/03 00/00/00	
CRN 2 sx	935714	PIASTRA FERMO PORTA 'SX'PV'AR MNSC LEFT LOCKING DOOR PLATE 'PV'AR MNSC	EN • AG60 • AS	19/09/03 00/00/00	
CRN 4	936009	PIAST.PER CERNIERA INF. AR/AF EN2/STAR PLATE FOR LOWER HINGE AR/AF EN2/STAR	EN_VTR • AG60	18/10/07 00/00/00	
kit CRN inv.	930096	KIT INVE.DX-SX POR.VETRO AR-POR.CIECA FROM RIGHT-LEFT INVERS. DOOR & GLASS D. KIT	EN • EN_VTR	__ 00/00/00	
kit CRN inv.	930205	KIT INVE.SX-DX POR.VETRO AR-POR.CIECA FROM LEFT-RIGHT INV. DOOR	EN • AG60	__ 00/00/00	
kit CRN 1/2 inv.	930210	KIT INV.SX-DX 1/2 PORTE EN FROM LEFT-RIGHT INVERS. KIT HALF DOORS EN	EN • AG60	01/01/95 31/07/09	
kit CRN 1/2 inv.	930201	KIT INVER.DX-SX PORTA MEZZA AR EN FROM RIGHT-LEFT INV. HALF DOOR KIT EN CAB.	EN • AG60	__ 31/07/09	
	930311	KIT INV.1/2 PORTE DA DX A SX AR EN 2009 FROM RIGHT- LEFT INV. KIT X 1/2 DOOR EN C.		01/08/09 00/00/00	
kit CRN 1/2V inv.	930202	KIT INVER.DX-SX PORTA 1/2 VETRO GOLD FROM RIGHT-LEFT HALF GLASS DOOR KIT GOLD	EN_VTR	__ 00/00/00	
CRNS dx	936011	KIT CERNIERA SUPERIORE'DX'+MOLLA AR MN UPPER RIGHT HINGE + SPRING AR MNSC	EN • AG60	01/10/07 00/00/00	
CRNS sx	936012	KIT CERNIERA SUPERIORE'SX'+MOLLA AR MN UPPER LEFT HINGE + SPRING AR MNSC	EN • AG60	01/10/07 00/00/00	
CRNS V	935071	ASS. CERNIERA SUP. DX-SX PORTE VTR EN UPPER LEFT/RIGHT HINGE GLASSES DOOR EN	EN_VTR • AS_VTR	28/11/02 00/00/00	
CRNS 1 dx	935314	CERNIERA SUPERIORE'DX'AR MNSC P/VET UPPER RIGHT HINGE AR MNSC GLASSES DOOR	EN • AG60 • AS	01/01/95 00/00/00	
CRNS 1 sx	935315	CERNIERA SUPERIORE'SX'AR MNSC P/VET UPPER LEFT HINGE AR MNSC GLASSES DOOR	EN • AG60 • AS	01/01/95 00/00/00	
CRN 3 dx	935057	MOLLA PER PORTA DX ARMADI RIGHT SPRING FOR CABINET DOORS	EN	01/01/95 00/00/00	
CRN 3 sx	935058	MOLLA PER PORTA SX ARMADI LEFT SPRING FOR CABINET DOORS	EN	01/01/95 00/00/00	
CRNS 3V dx	935696	MOLLA PORTA DX ARMADI CANOTTO IN ABS RIGHT SPRING FOR CABINET DOORS ABS TUBE	EN_VTR • AG60 • AS_VTR	01/01/95 00/00/00	
CRNS 3V sx	935697	MOLLA PORTA SX ARMADI CANOTTO IN ABS LEFT SPRING FOR CABINET DOORS ABS TUBE	EN_VTR • AG60 • AS_VTR	01/01/95 00/00/00	
CRN CR	936041	CERNIERA BISCOTTO ACC.ZN .MM 15X100 HINGE FOR FR. PANEL GALV. STEEL MM 15X100	EN • AG60 • AS	01/01/95 00/00/00	
CV/E	925862	CABLAGGIO DOPPIO VENTIL.TF NEW L=2200 WIRING DOUBLE FAN TF NEW L=2200	AG60 • AL • AS	__ 00/00/00	
CV/E	935072	CABLAGGIO TERM. SICUR. AR FERMALIEVITA THERM. SAF.WIRING FOR CONTR. PROVING CAB.	EN1 H2O SILVER • AL • AS	16/03/04 00/00/00	
CS	935650	ASS.CUPOLA SCHIUM.AR SILVER/EN INSULATED DOME SILVER/EN CABINETS	EN • AG60 • AS	19/07/01 00/00/00	
DIS	996503	DISTANZIALE IN NYLON 6,3X15X25 DCK82 NYLON SPACER 6,3X15X25 DCK82	AG60 • AS	24/07/00 00/00/00	

referim. reference	codice code	descrizione description	modello model	da...a from...to	ricambi cons. rec. spare part
DIS	996503	DISTANZIALE IN NYLON 6,3X15X25 DCK82 NYLON SPACER 6,3X15X25 DCK82	EN1	24/07/00 12/11/08	
	935073	DISTANZIALE IN PLASTICA AR EN L=40 NYLON SPACER L=40 EN CABINETS		13/11/08 00/00/00	
E	995574	TERMOSTATO F2000 +30+90°C C.1500 THERMOSTAT F2000 +30+90°C C.1500	EN -P • AL • AG60 -P • AS	12/01/01 00/00/00	●
EV	935611	EVAPORATORE 2 RANGHI AR SILVER/EN EVAPORATOR 2 ROWS SILVER/EN CABINET	AR-EN1 • AF-EN1 • ARP-EN1 • AL-EN1	07/06/00 00/00/00	
EV	935613	EVAPORATORE 3 RANGHI AR SILVER/EN EVAPORATOR 3 ROWS SILVER/EN CABINET	AF-EN_VTR • AF-EN2 • AF-EN ICE • AR-EN2 • ARP-EN2 • AL-EN2 • AG60 • AS	12/07/01 00/00/00	
EV	935615	EVAP.36 TUBI PASSO DIFF. AR SILVER/EN EVAPORATOR 36 TUBES SILVER/EN CABINETS	AF-EN2 SUPER • AF-EN2_VTR ICE	07/06/00 00/00/00	
F	995376	FILTRO DISIDRATORE 15 GR 6X3 DEHYDRATOR FILTER 15 GR 6X3	AR-EN1 • ARP-EN1 • AL-EN1	01/01/95 00/00/00	
F	995377	FILTRO DISIDRATORE 25 GR 6X3 DEHYDRATOR FILTER 25 GR 6X3	AF-EN1 • AR-EN2 • ARP-EN2 • AL-EN2 • AG60 SILVER H2O • AS	01/01/95 00/00/00	
F	995482	FILTRO DISIDRATORE 40 GR 6X3 DEHYDRATOR FILTER 40 GR 6X3	AG60	01/01/95 00/00/00	
F	995690	FILTRO DISIDRATORE ODF DML032S 023Z455 DEHYDRATOR FILTER ODF DML032S 023Z455	AL SUPER • AF-EN2 SUPER	01/01/95 00/00/00	
FA	935997	FILTRO X GOMMA ALIMENT.IDR.3/4' FILTER FOR HOSEPIPE 3/4'	AL • AS	24/05/02 00/00/00	
FRE	935695	FRONTALINO ESTERNO AR IRIIDIUM EXTERNAL FRONTAL PANEL IRIIDIUM CABINET	EN GOLD • ARP • AG60 GOLD • AS	11/04/03 00/00/00	
FRI	935694	FRONTALINO INTERNO AR IRIIDIUM INSIDE FRONTAL PANEL IRIIDIUM CABINET	EN GOLD • ARP • AG60 GOLD • AS	11/04/03 00/00/00	
G	996200	TELETERMOSTATO ID974 EN TN/BT TELEETHERMOSTAT ID974 EN TN/BT	EN SILVER • AG60 SILVER	29/05/03 00/00/00	●
G	996033	TELETERMOSTATO EWPX 174 (BUZZER) AR TELEETHERMOSTAT EWPX 174 (BUZZER) CABINETS	AF-EN2_SUPER SILVER	01/01/95 28/05/03	●
	996253	TELETERMOSTATO ID974LX EN TELEETHERMOSTAT ID974LX EN		29/05/03 00/00/00	●
G1	990228	SCHEDA DI POTENZA FERMALIEV MICRO PIU POWER CARD CONTROLLED PROVING MICRO PIU	AL	28/07/99 10/11/10	●
	997011	SCHEDA DI POTENZA AR/TL FL EVC FL08 POWER CARD AR/TL FL EVC FL08		11/11/10 00/00/00	●
G1	996211	SCHEDA DI POTENZA SERIE IRIIDIUM 08/2002 POWER CARD IRIIDIUM 08/2002	EN GOLD • AF-EN_VTR ICE • ARP • AG60 GOLD	01/01/95 05/06/08	●
	996714	SCHEDA DI POTENZA EVCO IRIIDIUM POWER CARD IRIIDIUM EVCO		06/06/08 00/00/00	●
G1+G2	996309	SCHEDA COMANDO+POTENZA AR IRIIDIUM COMMAND + POWER CARD IRIIDIUM	EN GOLD • AF-EN_VTR ICE • ARP • AG60 GOLD	01/01/95 05/06/08	●
	996614	ASS.SCHEDA ELET.EVCO IRIIDIUM COMMAND + POWER CARD IRIIDIUM EVCO		06/06/08 00/00/00	●
G1+G2	996792	SCHEDA ELET.EVCO IRIIDIUM STAGIONATORE ELECTRIC CARD EVCO IRIIDIUM SEASONER	AS	04/02/09 00/00/00	●
G1+G2	997016	ASS.SCHEDA AR/TL FERMALIEV. FL EVC FL08 PROVING ELECTRIC CARD AR/TL FL EVC FL08	AL	11/11/10 00/00/00	●
G2	990227	SCHEDA DI COMANDO FERMALIEV MICRO PIU COMMAND CONTROLLED PROV. CARD MICRO PIU	AL	01/01/95 10/11/10	●
	997013	SCHEDA TASTIERA AR/TL FL EVC FL08 COMMAND CARD AR/TL FL EVC FL08		11/11/10 00/00/00	●
G2	996212	SCHEDA DI COMANDO SERIE IRIIDIUM 08/2002 COMMAND CARD IRIIDIUM 08/2002	EN GOLD • AF-EN2_VTR ICE • ARP • AG60 GOLD	01/01/95 05/06/08	●
	996715	SCHEDA DI COMANDO EVCO IRIIDIUM COMMAND CARD EVCO IRIIDIUM		06/06/08 00/00/00	●
G3	990229	SCHEDA AUSILIARIA FERMALIEV MICRO PIU AUX. CONTROLLED PROVING CARD MICRO PIU	AL	28/07/99 11/11/10	●
	997012	SCHEDA DI ESPANSIONE AR/TL FL EVC FL08 EXPANSION CARD AR/TL FL EVC FL08		11/11/10 00/00/00	●
GA	935679	GOMMA ALIMENTAZ. IDR. 3/4 GAS L=2500 HOSEPIPE 3/4 GAS L=2500	AL	21/02/02 00/00/00	
GC x1	990586	GUIDA SINGOLA 'C' PER EN2 ICE 'C' SLIDE FOR EN2 ICE	AF-EN2 ICE • AS	04/05/05 00/00/00	
GC x2	990443	COPPIA GUIDE A 'C' PER EN2 ICE PAIR OF 'C' SLIDES FOR EN2 ICE	AF-EN2 ICE • AS	04/05/05 00/00/00	
GC x2	996696	COPPIA GUIDE 'C' DA 620 PER AR EN GELA PAIR OF 'C' SLIDES 620 FOR EN ICE CABINETS	AG60	18/06/08 00/00/00	

referim. reference	codice code	descrizione description	modello model	da...a from...to	ricambi cons. rec. spare part
GL x1	935669	GUIDA A 'L' DA 730 PER TEGLIE AR EN2 'L-SHAPED' SLIDE L=730 FOR BAKING TINS EN2	EN2	07/01/02 00/00/00	
GL x1	935672	GUIDA A 'L' DA 450 PER TEGLIE AR EN1 'L-SHAPED' SLIDE L=450 FOR BAKING TINS EN1	EN1	10/12/01 00/00/00	
GL x2	990332	COPPIA GUIDE A'L'PER EN1 PAIR OF 'L' SLIDES FOR EN1	EN1	10/12/01 00/00/00	
GL x2	990333	COPPIA GUIDE A'L'PER EN2 PAIR OF 'L' SLIDES FOR EN2	EN2	07/01/02 00/00/00	
GPO	935638	GUARNIZ. PORTA INTERA 670X1540 AR EN DOOR GASKET 670X1540 EN CABINETS	EN • AG60 • AS	01/01/95 16/05/07	●
	936649	NN22 GUARN.PORTA INTERA 640X1495 AR EN NN22 DOOR GASKET 640X1495 EN CABINETS		17/05/07 00/00/00	●
GPO 1/2	935639	GUARNIZ. PORTA MEZZA 670X740 AR EN1/EN2 HALF DOOR GASKET 670X740 EN1/EN2 CABINETS	EN • AG60	01/01/95 16/05/07	●
	936672	GUARN.PORTA 1/2 640X695 AR EN NEW HALF DOOR GASKET 640X695 EN1 NEW CABINETS		17/05/07 00/00/00	●
GPO V	935954	GUARNIZ.PORTA VETRO AR EN GLASS DOOR GASKET EN CABINETS	EN	12/07/06 31/12/08	●
	997026	GUARN. MM.648X1508 AR EN VTR 2008 GASKET MM.648X1508 FOR GLASS DOOR 2008		01/01/09 00/00/00	●
GPV	925527	GRIGLIA PROTEZIONE VENTILAT.4715FS FAN PROTECTION GRID 4715FS	EN_H2O • AG60 H2O	14/02/02 00/00/00	
GPV	935194	GRIGLIA PROTEZIONE VENTILATORE AR VINI FAN PROTECTION GRID WINES CABINETS	AS	05/02/09 00/00/00	
GR	990026	GRIGLIA EN 400X600 PLASTIFICATA PLASTICIZED SHELF EN 400X600	AF-EN ICE	07/10/03 00/00/00	
GR	990027	GRIGLIA GN2/1 INOX GN2/1 SHELF INOX	AG60	20/05/08 00/00/00	
GR ICE	996695	RIPIANO AR EN GELATO SHELF EN ICE CABINET	AG60	20/05/08 00/00/00	
GS EN	935673	MONT.X GUIDA A 'L' X TEGLIE AR EN1/EN2 UPRIGHTS FOR 'L' GUIDES BAKING TINS EN1/2	EN • AG60	10/12/01 00/00/00	
GS ICE	936648	ASS.MONTANTI VERS.GN PER ARMADI EN UPRIGHTS GN VERSION FOR EN CABINETS	AG60 • AS	20/05/08 00/00/00	
H	995402	LAMPADA SPIA GIALLA AR YELLOW INDICATOR LIGHT CABINETS	AF-EN SILVER • AG60 SILVER	13/10/03 00/00/00	
I1	935074	DEVIATORE BIPOLARE LUMINOSO VERDE FL B04 BIPOLAR SWITCH GREEN LIGHT B04	AR-EN SILVER	13/10/03 00/00/00	
I1	935075	INTER. UNIP. VERDE + DEV. UNIP. VERDE MAIN SWITCH GREEN + DEFL. UNIP. GREEN C/BL	AR-EN_VTR SILVER	13/10/03 00/00/00	
I3	995405	MICROPORTA MAGNETICO STEM E510 DOOR MICRO-SWITCH STEM E510	EN GOLD • ARP • AG60 GOLD	01/01/95 00/00/00	●
I3	996356	MICROINTERRUTTORE PORTA AR MICRO-SWITCH DOOR CABINETS	EN1 SILVER • AG60 SILVER	01/01/95 31/12/07	●
	936091	BN MICROINT. MECCANICO 3 TERMINALI BN MECHANICAL MICRO-SWITCH 3 TERMINALS		01/01/08 00/00/00	●
I3	995047	MAGNETE X MICROPORTA MND IAM 018 005T MAGNET FOR MICRO-S. DOOR MND IAM 018 005T	EN_VTR • ARP_VTR • AG60 GOLD • AS	12/06/08 00/00/00	
IG	995410	INTERRUTT.VERDE+SPIA GIALLA AR P.V. GREEN SWITCH + YELLOW LIGHT DOOR GLAS. C.	AF-EN1_VTR SILVER • AF-EN2 SILVER	13/10/03 00/00/00	
IG	995647	*****INTERRUTTORE BIP.LUM BLU 0401/2/C MAIN SWITCH BLUE LIGHT	EN SILVER	01/01/95 27/05/03	
	995257	INTERRUTTORE GENERALE VERDE C/GRIGIA MAIN SWITCH GREEN C/GRAY		28/05/03 00/00/00	
IG	995257	INTERRUTTORE GENERALE VERDE C/GRIGIA MAIN SWITCH GREEN C/GRAY	AG60 SILVER	28/05/03 00/00/00	
IG	996032	INTERRUTTORE BIPOLARE LUMINOSO BIANCO BIPOLAR SWITCH LIGHT WHITE	AL_VTR	28/06/07 00/00/00	
kit CE/M3	930295	KIT CONV/RES/VENT AR EN NEW CONVEYOR/RESIST./FAN KIT EN AR NEW	AR-EN • ARP • AL	11/11/05 00/00/00	
kit CE/M3	930296	KIT CONV/RES/VENT AF EN NEW CONVEYOR/RESIST./FAN KIT EN AF NEW	AF-EN • AL-EN2 SUPER	11/11/05 00/00/00	
kit CO H2O	996655	KIT CONDENS.ACQUA SALDOBRAZ B5/ZC207 WATER CONDENSER KIT BRAZED B5/ZC207	EN_H2O • AG60 H2O	20/11/05 00/00/00	
kit CO+M2	990396	KIT CONDENSAZIONE ACQUA B5 + VENTILATO WATER CONDENSER KIT B5 + FAN	EN_H2O	20/11/05 00/00/00	
kit I3	995264	MICROINTERRUTTORE+PIASTRINA PORTA AR MICRO-SWITCH + DOOR CABINETS PLATE	EN SILVER	01/01/95 31/12/07	●

riferim. reference	codice code	descrizione description	modello model	da...a from...to	ricambi cons. rec. spare part
kit M2	995525	MOTORE+VENTOLA COND. STVF 93-139 ENGINE + CONDENSER FAN STVF 93-139	> 995522 > 995524	19/11/05 00/00/00	●
kit M2	995526	MOTORE+VENTOLA COND. STVF 124/194 ENGINE + CONDENSER FAN STVF 124/194	> 995523	08/04/03 00/00/00	●
kit M2	996161	MOTORE+VENTOLA COND. STVF 273 ENGINE + CONDENSER FAN STVF 273	> 995908	08/04/03 00/00/00	●
LL	995757	LIVELLOSTATO 'MOD.P500' LIEVITAMATIC LEVEL CONTROL 'MOD.P500' LIEVITAMATIC	AL • AS	21/02/02 00/00/00	
M1	995711	COMPRESSORE 34,37CC J2212GK CSR R404A COMPRESSOR 34,37CC J2212GK CSR R404A	AF-EN2 SUPER • AF-EN2 ICE_VTR	01/03/98 00/00/00	
M1	995746	COMPRESS. 20,4 CC T2178GK/SC18CL R404A COMPRESSOR 20,4 CC T2178GK/SC18CL R404A	AF-EN1_VTR • AF-EN1 ICE	15/09/08 00/00/00	
M1	995770	COMPRESS. 22,4 CC.T2180GK-SC21CL R404A COMPRESSOR 22,4 CC.T2180GK-SC21CL R404A	AF-EN2 • AF-EN2 ICE • AL-EN2 SUPER • AG60	30/04/97 00/00/00	
M1	995983	COMPRESSORE DANFOSS SC 15 G R134A COMPRESSOR DANFOSS SC 15 G R134A	AL-EN2 • AS	03/11/05 00/00/00	
M1	995740	COMPRESSORE NL7.3MF FR8.5G/B6160Z R134 COMPRESSOR NL7.3MF FR8.5G/B6160Z R134	AR-EN1 • ARP-EN1	01/03/98 05/11/06	
	996353	COMPRESS.DANFOSS NL7.3MF R134A 230/50-60 COMPRESSOR DANF. NL7.3MF R134A 230/50-60		06/11/06 00/00/00	
M1	995742	COMPRESSORE 8,85 CC B6170Z/FR10G R13 COMPRESSOR 8,85 CC B6170Z/FR10G R13	AL-EN1	01/03/98 00/00/00	
M1	995743	COMPRESSORE 12,00 CC E6187Z/SC12G R134 COMPRESSOR 12,00 CC E6187Z/SC12G	AR-EN2 • ARP-EN2	01/03/98 12/03/06	
	996355	COMPRESS.DANFOSS NL10 MF R134A 230/50-60 COMPRESSOR DANF. NL10 MF R134A 230/50-60		13/03/06 00/00/00	
M1	996725	COMPRESSORE DANFOSS SC 15 CLX.2 R404A COMPRESSOR DANFOSS SC 15 CLX.2 R404A	AF-EN1 • AL-EN1 SUPER	15/09/08 10/05/11	
	995745	COMP. 17,4 CC NEK2168GK/SC15CL R404 COMPR. 17,4 CC NEK2168GK/SC15CL R404		11/05/11 00/00/00	
M2	995635	VENTIL. PIATTO D=120 230V 4715MS-23T-B FLAT FAN D=120 230V 4715MS-23T-B	EN_H2O	14/02/02 00/00/00	●
M3	935581	VENTIL.TANGENZ.AR SILV/EN L.CAVO 1800 TANGENT FAN AR SILV/EN 1800 LONG LINE	AG60 ARIA/ACQUA AG60 AIR/WATER	14/11/04 00/00/00	●
M3	935581	VENTIL.TANGENZ.AR SILV/EN L.CAVO 1800 TANGENT FAN AR SILV/EN 1800 LONG LINE	EN • ARP • AL • AG60 • AS	14/11/04 03/11/08	●
	995635	VENTIL. PIATTO D=120 230V 4715MS-23T-B FLAT FAN D=120 230V 4715MS-23T-B		04/11/08 00/00/00	●
M3	935630	VENTIL. MA-VIB EVF10A 200-27° AP + VIT FAN MA-VIB EVF10A 200-27° AP	AF-EN2 SUPER	18/06/01 00/00/00	●
M4	915008	VENTILAT FANDIS A08A23SWBY00 80X80 FLAT FAN FANDIS A08A23SWBY00 80X80	AS	05/02/09 00/00/00	●
kit M3	935647	VENTIL. MA-VIB EVF10A 200-27° AP + VIT FAN MA-VIB EVF10A 200-27° AP	AF-EN2 SUPER	23/05/01 00/00/00	●
MAS	935884	MASCHERINA COMANDI IRIIDIUM GRIGIA FRX CONTROL PANEL IRIIDIUM GRAY FRX	AS	28/04/04 00/00/00	
MAS	935890	MASCHERINA COMANDI IRIIDIUM GIALLA FRX CONTROL PANEL IRIIDIUM YELLOW FRX	EN GOLD • ARP • AG60 GOLD	28/04/04 00/00/00	
MAS	995977	MASCHERINA COMANDI FERMALIEVITA MICRO+ CONTROL PANEL FOR CONTR. PROVING MICRO	AL	01/01/95 10/11/10	
	997014	MASCHERINA AR/TL FL EVC FL08 FRX CONTROL PANEL FOR AR/TL FL EVC FL08 FRX		11/11/10 00/00/00	
MAS T	935652	MASC.PASTICC. AR EN1-2 RESINATA BAKING CONTROL PANEL EN1-2 CAB. RESINED	AR-EN SILVER	26/01/05 00/00/00	
MAS T	935076	MASCH. COMANDI AR EN1-EN2 BT RESINATA CONTROL PANEL EN1-EN2 CABINET RESINED	AF-EN SILVER • AG60 SILVER	26/01/05 00/00/00	
MN	935955	MANIGLIA PORTA VTR AR STAR NEW HANDLE FOR GLASS DOOR STAR CABINETS NEW	EN_VTR	01/09/08 00/00/00	
MN	935195	MANIGLIA PORTA VETRO SUT / EN 2009 HANDLE FOR GLASS DOOR SUT / EN 2009	AS_VTR	04/02/09 00/00/00	
MT	995496	MANOPOLA X TIMER-COMMUTATORE TIMER-COMMUTATOR CONTROL	AF-EN SILVER • AG60 SILVER	27/02/02 00/00/00	●
O	995393	PROGRAMMATORE DI CICLI 230V CYCLES PROGRAMMER 230V	AF-EN • AG60 SILVER	16/12/99 00/00/00	
OR	995714	ORIFIZIO N°0,5-FLICA N°0,5 ORIFICE - FLICA	AR-EN-P • AL-EN SUPER	29/11/00 04/04/04	
	996208	ORIFIZIO N°00 DANFOSS N°00 ORIFICE DANFOSS		05/04/04 00/00/00	

referim. reference	codice code	descrizione description	modello model	da...a from...to	ricambi cons. rec. spare part
OR	995717	ORIFIZIO N°1,5--FLICA N°1,5 ORIFICE - FLICA	AF-EN-P • AF-EN2 SUPER • AL-EN1 -P • AL-EN2 SUPER • AG60 -P	15/02/01 04/04/04	
	996263	ORIFIZIO N°01 ODF DANFOSS N°01 ORIFICE ODF DANFOSS		05/04/04 00/00/00	
P	995240	PRESSOSTATO KP 5 AUTOMATICO HP KP 5 PRESSURE SWITCH AUTOMATIC HP	EN2_H2O • AG60 H2O	17/11/05 00/00/00	●
P/I3	935898	PIASTRINA ISOLANTE MICRO PORTA INSULATING PLATE FOR MICRO-SWITCH	EN SILVER	01/01/95 31/12/07	
PC G	965648	PARACOLPO D=20,5 H=7,6 BUMPER D=20,5 H=7,6	EN • AG60 • AS	01/01/95 00/00/00	
PI 1	990581	ASS.PIEDINO 2" FOOT ASSEMBLY 2'	EN • AG60 • AS	02/04/04 18/09/07	
	930269	ASSIEME PIEDINO TR NEW 2' H=145-205 FOOT ASSEMBLY TR NEW 2' H=145-205		19/09/07 00/00/00	
PI 2	995012	PIEDE INOX LISCIO DA 2"G AR MNSC INOX FOOT 2' G MNCQ CABINETS	EN • AG60 • AS	02/04/04 18/09/07	
	995024	PIEDINO INOX 2' GAS L= 92 AR TR INOX FOOT 2' GAS L=92 TR CABINETS		19/09/07 00/00/00	
PI 4	995011	SUPPORTO PIEDE INOX AR MNSC AGF0082 INOX FOOT SUPPORT MNCQ CABINETS AGF0082	EN • AG60 • AS	02/04/04 18/09/07	
	995025	ASS.SUP.PIEDE PIASTRA L=130 AR EN+TR N INOX FOOT SUPPORT L=130 EN+TR CAB. NEW		19/09/07 00/00/00	
PL	935633	PANNELLO LAT DX AR EN1 RIGHT SIDE PANEL EN1 CABINETS	EN1	11/07/01 12/11/08	
	935077	PANNELLO LATERALE DX AR EN1 NEW RIGHT SIDE PANEL EN1 CABINETS NEW		13/11/08 00/00/00	
PL	935634	PANNELLO LAT.SX AR EN1 LEFT SIDE PANEL EN1 CABINETS	EN1	11/07/01 12/11/08	
	935078	PANNELLO LATERALE SX AR EN1 NEW LEFT SIDE PANEL EN1 CABINETS NEW		13/11/08 00/00/00	
PL	935635	PANNELLO LAT DX AR EN2 RIGHT SIDE PANEL EN2 CABINETS	EN2 • AS	11/07/01 13/11/08	
	935079	PANNELLO LATERALE DX AR EN2 NEW RIGHT SIDE PANEL EN2 CABINETS NEW		14/11/08 00/00/00	
PL	935636	PANNELLO LAT SX AR EN2 LEFT SIDE PANEL EN2 CABINETS	EN2 • AS	11/07/01 13/11/08	
	935085	PANNELLO LATERALE SX AR EN2 NEW LEFT SIDE PANEL EN2 CABINETS NEW		14/11/08 00/00/00	
PL	936645	PANNELLO LAT.SX AR EN GELATO LEFT SIDE PANEL EN ICE CABINET	AG60	20/05/08 00/00/00	
PL	936646	PANNELLO LAT.DX AR EN GELATO RIGHT SIDE PANEL EN ICE CABINET	AG60	20/05/08 00/00/00	
PO	935641	ASS.PORTA INTERA AR EN1/EN2 DOOR FOR EN1/2 CABINETS	EN SILVER	01/01/95 12/11/08	
	935086	ASSIEME PORTA INTERA AR EN-EN2 NEW DOOR FOR EN1/2 CABINETS NEW		13/11/08 00/00/00	
PO	935911	ASS.PORTA INTERA AR EN1/EN2 GOLD DOOR FOR EN1/EN2 CABINETS GOLD	EN GOLD • AG60 GOLD • AL-EN2 • AS	01/01/95 12/11/08	
	936651	ASS.PORTA INTERA AR EN GOLD NEW DOOR FOR EN CABINETS GOLD NEW		13/11/08 00/00/00	
PO	935641	ASS.PORTA INTERA AR EN1/EN2 DOOR FOR EN1/2 CABINETS	AL-EN1	01/01/95 17/12/07	
	935911	ASS.PORTA INTERA AR EN1/EN2 GOLD DOOR FOR EN1/EN2 CABINETS GOLD		18/12/07 00/00/00	
PO	936650	ASS.PORTA INTERA AR EN PANNELLATA DOOR EN CABINET paneled	AG60 SILVER	20/05/08 00/00/00	
PO 1/2	935642	ASS PORTA MEZZA AR EN1/EN2 HALF DOOR EN1/EN2 CABINETS	EN SILVER	01/01/95 12/11/08	
	935087	ASSIEME PORTA MEZZA AR EN1-EN2 NEW HALF DOOR EN1/EN2 NEW CABINETS		13/11/08 00/00/00	
PO 1/2	935915	ASS.PORTA 1/2 AR EN1/EN2 GOLD HALF DOOR EN1/2 CABINETS GOLD	EN1 GOLD	08/11/04 12/11/08	
	935088	ASSIEME PORTA MEZZA AR EN GOLD NEW HALF DOOR EN1/2 CABINETS GOLD NEW		13/11/08 00/00/00	
PO 1/2	935916	ASS.PORTA 1/2 INF.DX AR EN1/EN2 GOLD LOWER RIGHT HALF DOOR EN1/EN2 CAB. GOLD	EN GOLD	08/11/04 12/11/08	
	935089	ASS. PORTA MEZZA INF. DX AR EN GOLD NEW LOWER RIGHT HALF DOOR EN CAB. GOLD NEW		13/11/08 00/00/00	

referim. reference	codice code	descrizione description	modello model	da...a from...to	ricambi cons. rec. spare part
PO 1/2	6234360	ASS.PORTA MEZZA SCH.INF.SX AR EN GOLD LOWER LEFT HALF DOOR EN CABINETS GOLD	EN GOLD	08/11/04 12/11/08	
	935094	ASS. PORTA MEZZA INF. SX AR EN GOLD NEW LOWER LEFT HALF DOOR EN CAB. GOLD NEW		13/11/08 00/00/00	
PO 1/2	935120	ASS. PORTA 1/2 SUP. DX/SX AR EN PANN. RIGHT/LEFT UPPER HALF DOOR EN CABINETS	AG60 SILVER	23/02/09 00/00/00	
PO V	935900	PORTA VTR DX TN 2VTR B.E. AR EN NEW RIGHT GLASS DOOR TN 2 GLASSES EN CAB. NEW	AR-EN_VTR • ARP	01/01/95 17/11/08	
	935095	PORTA VTR DX TN 2VTR B.E. AR EN NEW RIGHT GLASS DOOR TN 2 GLASSES EN CAB. NEW		18/11/08 00/00/00	
PO V	935901	PORTA VTR SX TN 2VTR B.E. AR EN NEW LEFT GLASS DOOR TN 2 GLASSES EN CAB. NEW	AR-EN_VTR • ARP	01/01/95 17/11/08	
	935096	PORTA VTR SX TN 2VTR B.E. AR EN NEW LEFT GLASS DOOR TN 2 GLASSES EN CAB.		18/11/08 00/00/00	
PO V	935902	PORTA VTR 3VTR RISC.DX+LUCE+VAR.TEN.NEW RIGHT GLASS DOOR 3 GLASS. WARMED + LIGHT	AF-EN_VTR • AL	01/01/95 17/11/08	
	935098	PORTA VTR 3VTR RISC. DX + LUCE EN NEW RIGHT GLASS DOOR 3 GL.WARMED+LIGHT EN NEW		18/11/08 00/00/00	
PO V	935903	PORTA VTR 3VTR RISC.SX+LUCE+VAR.TEN.NEW LEFT GLASS DOOR 3 GLASSES WARMED + LIGHT	AF-EN1_VTR • AL	01/01/95 17/11/08	
	935097	PORTA VTR 3VTR RISC. SX + LUCE EN NEW LEFT GLASS DOOR 3 GL. WARMED+LIGHT EN NEW		18/11/08 00/00/00	
PO V	935196	PORTA VETRO 2VTR DX LED AR EN 2009 RIGHT GLASS DOOR 2 GLASSES LED EN 2009 CAB.	AS_VTR	04/02/09 00/00/00	
PR 3	996600	RUOTA GIR D=100 3477PJO100/30P62 C/F REVOLVING CASTOR D=100 WITH BRAKES	EN • AG60 • AL • AS	__ 00/00/00	
PR 4	996599	RUOTA GIR D=100 3470PJO100/30P62 S/F REVOLVING CASTOR D=100 WITHOUT BRAKES	EN • AG60 • AL • AS	__ 00/00/00	
PVE	995776	ASS.SEMIPROT.VALVOLA 'FLICA-DANFOSS' SEMI-PROTECTION VALVE 'FLICA/DANFOSS'	-P • AF-EN2 SUPER • AL-EN SUPER	29/11/00 00/00/00	
Q	995712	RELE'AVV.3ARR3B3AV3 RVA112 (J2212GK START. RELAY 3ARR3B3AV3 RVA112 (J2212GK	> 995711	30/01/01 00/00/00	●
Q	996017	RELE' AVVIAMENTO DANFOSS '117U6003' STARTING RELAY DANFOSS '117U6003'	> 995743	01/03/98 00/00/00	●
Q	996018	RELE' AVVIAMENTO DANFOSS '117U6005' STARTING RELAY DANFOSS '117U6005'	> 995983	15/11/01 00/00/00	●
Q	996019	RELE' AVVIAMENTO DANFOSS '117U6010' STARTING RELAY DANFOSS '117U6010'	> 995742	15/11/01 00/00/00	●
Q	996021	RELE' AVVIAMENTO DANFOSS '117U6019' STARTING RELAY DANFOSS '117U6019'	> 996725 > 995747	11/06/08 00/00/00	●
Q	996548	RELE' AVVIAMENTO DANFOSS '117U6016' STARTING RELAY DANFOSS '117U6016'	> 996353 > 996354	01/06/07 00/00/00	●
Q	996549	RELE' AVVIAMENTO DANFOSS '117U6022' STARTING RELAY DANFOSS '117U6022'	> 996355	01/06/07 00/00/00	●
Q	996751	RELE' AVVIAMENTO DANFOSS '117U6013' STARTING RELAY DANFOSS '117U6013'	> 995746	11/06/08 00/00/00	●
Q1	995345	RELE'DI POTENZA 30A 250V POWER RELAY 30A 250V	AL	25/06/98 00/00/00	●
R1	935353	RESISTENZA PORTA INTERA AF MNSC 52W FRAME HEATER DOOR AF MNSC 52W	EN • AG60 SILVER • AL • AS	15/11/04 31/12/07	●
	935849	RES.BATT.GUARN.PORTA 31W PLANET/STAR FRAME HEATER DOOR 31W PLANET/STAR		01/01/08 00/00/00	●
R1	935190	RESISTENZA CORNICE PORTA L=4230 15W/M EN FRAME HEATER DOOR L=4230 15W/M EN	AG60 GOLD	01/01/08 00/00/00	●
R1	935354	RESISTENZA PORTE MEZZE AF MNSC 68W FRAME HEATER HALF DOORS AF MNSC 68W	AR-EN	01/01/95 00/00/00	●
R1	935354	RESISTENZA PORTE MEZZE AF MNSC 68W FRAME HEATER HALF DOORS AF MNSC 68W	AF-EN • AG60 SILVER	01/01/95 31/12/07	●
	935850	RES.BAT.GUARN.P.1/2 41W PLANET/STAR HALF DOORS FRAME HEATER 41W PLANET/STAR		01/01/08 00/00/00	●
R2	935614	RES.SBRIN.EVAP.3RANGHI AR SILVER/EN DEFR. RESIST. EV. 3 ROWS SILVER/EN CAB.	AF-EN2 • AF-EN1_VTR • AF-EN1_ICE • AR-EN2 • ARP-EN2 • AL-EN2 • AG60 • AS	01/07/05 00/00/00	●
R2	990337	RES.SBRIN.EVAP.2R AR-SILVER+CONT.MASCH DEFR. RESISTANCE EVAP. 2 ROWS SILVER CAB.	AR-EN1 • AF-EN1 • AR-EN1_VTR • ARP- EN1 • AL-EN1	14/11/04 00/00/00	●
R3	935616	RES. EVAPORAZ. 100W 230V EVAP. CONDENCE RESIST. 100W 230V	-P • AL • AS	12/01/01 00/00/00	●
R3	995941	RESISTENZA 190W UMIDIFIC. TR LIEVITAM. RESISTANCE HUMIDIF. 190 RC LIEVITAMATIC	AL • AS	21/02/02 00/00/00	●

referim. reference	codice code	descrizione description	modello model	da...a from...to	ricambi cons. rec. spare part
R4	936682	RESISTENZA H25 3C VT27 230V 500+500W RESISTANCE H25 3C VT27 230V 500+500W	AL • AS	07/03/02 00/00/00	●
R4	945005	RESISTENZA SCARICO CONDENSA CELLE 100W DISCHARGE COND. RESITANCE C. ROOMS 100W	ARP • AL	10/05/04 31/12/08	●
	996788	RESISTENZA PRALINERIA 150W CORAZZATA PRALINE RESISTANCE 150W		01/01/09 30/11/10	●
	935677	ASS.RESISTENZA+STAFFE EN2 LIEVITAMATIC HEATER ASS.+ FRAME FOR EN2 LIEVITAMATIC		01/12/10 00/00/00	●
R6	935876	RES.FLESS. DI SCARICO AR STAR 21W 230V DISCHARGE FLEX. RESIST. AR STAR 21W 230V	AF-EN1 • AF-EN2 • AG60	16/11/04 00/00/00	●
RL	995906	RICEVITORE DI LIQUIDO 0,58 LITRI LIQUID RICEIVER 0,58 LITERS	AF-EN2 SUPER • AL SUPER	07/10/06 00/00/00	
RP	945724	REGOLATORE PRESSIONE CRO-4-0/75 R404A PRESSION REGULATOR CRO-4-0/75 R404A	AG60 G/CALDO	16/11/04 00/00/00	
S	995851	STARTER PER TUBI AL NEON STARTER DEVICE FOR TUBULAR LAMP	EN_VTR	14/09/98 00/00/00	
S/MS	996745	SUPPORTO MAGNETE E SERRATURA MAGNET AND LOCKING SUPPORT	EN • AG60 • AS	21/11/08 00/00/00	
S/R4	935101	SUPP. RESISTENZE EN2 VENTOLE ASSIALI RESISTANCE SUPPORT EN2 AXIAL FAN	EN • AG60 • AS	04/11/08 00/00/00	
SCE	936027	ASS.SCATOLA ELETTR.AF STAR-EN-PLANET ELECTRIC BOX AF STAR-EN-PLANET	AF EN GOLD	08/11/04 05/06/08	
	936047	ASS.SCATOLA ELETTR.AR7-14 STAR-EN-PLANET ELECTRIC BOX ASS. AR7-14 STAR-EN-PLANET		06/06/08 00/00/00	
SCE	936047	ASS.SCATOLA ELETTR.AR7-14 STAR-EN-PLANET ELECTRIC BOX ASS. AR7-14 STAR-EN-PLANET	AR EN GOLD • ARP • AG60 GOLD	08/11/04 00/00/00	
SCE	990580	ASS.SCATOLA EL. AR EN ID974 ELECTRIC BOX ASS. EN CABINETS ID974	AR-EN SILVER	03/07/06 00/00/00	
SCE	935102	SCATOLA ELETT. AR FERMALIEVITA + TRIVAL. ELECTRIC BOX ASS. CONTROLLED PROVING CAB.	AL	15/06/98 10/11/10	
	6839750	ASS.SCATOLA ELETT. AL EN FERMALIEV.FL08 ELECTRIC BOX ASS. AL EN FERMALIEV.FL08		11/11/10 00/00/00	
SCE	935109	ASS.SCAT.EL.ARMADI AF EN1/EN2 ID974 ELECTRIC BOX ASS. AF EN1/EN2 CAB. ID974	AF-EN SILVER • AG60 SILVER	13/11/06 00/00/00	
SCE	935197	ASS. SCAT.EL. AR7 STAR EVCO STAGIONATORE ELECTRIC BOX AR7 STAR EVCO SEASONER	AS	04/02/09 00/00/00	
SCE/C	935103	COPERCHIO SCATOLA FERMALIEVITA ARMADI COVER. ELECT. BOX CONTROLLED PROVING CAB.	AL	15/06/98 10/11/10	
T	990319	TRASFORMATORE 230/24V 17VA 50/60HZ TRANSFORMER 230/24V 17VA 50/60HZ	AL	12/07/02 00/00/00	●
T	990435	TRASFORMATORE 230/24V 17VA 50/60HZ TRANSFORMER 230/24V 17VA 50/60HZ	EN GOLD	08/11/04 05/06/08	●
T2	915103	REATTORE PER NEON 36W 220V 50HZ BALLAST - 36W 220V 50HZ	EN_VTR • AS_VTR	17/12/04 00/00/00	
TAI	935191	GOMMA ALIMENTAZ.IDR.3/4 GAS L=2500 WATER FEEDING HOSEPIPE 3/4 GAS L=2500	AL • AS	11/11/08 00/00/00	
TEC	935104	SERPENTINA EVAP. COND. AR SILVER - AR EN COIL PIPE EV. DEFROST WATER EN SILV. CAB.	AR-EN • ARP • AL • AG60 H2O • AS	14/11/04 00/00/00	
TEC	935104	SERPENTINA EVAP.COND. AR SILVER/AR EN COIL PIPE EV. DEFROST WATER EN SILVER CAB.	AL-EN1 SUPER	11/06/00 06/10/08	
	935105	SERPENTINA EVAPORA COND. AF-EN2 BT COIL PIPE EV. DEFROST WATER AF-EN2		07/10/08 00/00/00	
TEC	935105	SERPENTINA EVAPORA COND. AF-EN2 BT COIL PIPE EV. DEFROST WATER AF-EN2 R404A	AF-EN1 • AF-EN2 • AF-EN2 ICE • AG60	11/06/00 00/00/00	
TEC	935106	SERP. EV.COND. AR SILVER-AR EN COND. H2O COIL PIPE EV. DEFR.WATER EN WATER COND.	EN1_H2O	11/06/00 00/00/00	
TEC	935107	SERP. EVAPORA COND.EN2 SUPER-SILVER P.V. COIL PIPE EV. DEFROST WATER EN2 SUPER-SIL.	AF-EN2 SUPER • AL-EN2 SUPER	18/07/01 00/00/00	
TG	996148	TUBO FLEX GOMMA+CALZA 3/8M-1/2F L=200 FLEX PLAST. TUBE+BRAIDING 3/8M-1/2F L=200	EN_H2O • AG60 H2O	09/05/02 00/00/00	
TR	935643	ASS.TRAVERSA PORTA MEZZA AR EN1/EN2 CROSSBEAM HALF DOOR EN1/2 CABINET	EN • AG60	01/12/99 12/11/08	
	935110	ASS.TRAVERSA PORTA MEZZA AR EN1/EN2 NE CROSSBEAM HALF DOOR EN1/2 NEW CAB.		13/11/08 00/00/00	
TS	935998	NN12 SCAMBIATORE AF14 SILVER / AF-EN2 NN12 EXCHANGER AF14 SILVER / AF-EN2	AF-EN1_VTR • AF-EN2 • AF-EN ICE • AG60	07/06/00 00/00/00	
TS	936058	SCAMBIATORE AR EN1-EN2+IRIDIUM EXCHANGER EN1-EN2+IRIDIUM CABINET	AR-EN • AL • ARP-EN1 • ARP-EN2 • AS	07/06/00 00/00/00	

referim. reference	codice code	descrizione description	modello model	da...a from...to	ricambi cons. rec. spare part
TS	996491	NN12 SCAMBIATORE AF7 SILVER / AF-EN1 NN12 EXCHANGER AF7 SILVER / AF-EN1	AF-EN1	07/06/00 00/00/00	
TS	935108	ASS.SCAMBIATORE 1,24X1900 AF14VTR SILVER EXCHANGER 1,24X1900 AF14VTR SILVER	AF-EN2_VTR ICE	14/11/04 00/00/00	
TSC	936661	TUBO SCARICO BAC.EVAP.AR EN DRAIN EVAPORATOR COND. TUBE EN CABINETS	EN • AG60 • AS	07/06/00 00/00/00	
V1	995682	VALVOLA SOL.CASTEL ACQUA F-F 3/8"230V SOLENOID VALVE CASTEL WATER F-F 3/8"230V	AL • AS	16/03/04 00/00/00	●
V1	995336	VALVOLA SOLENOIDE 1/4"A SILDARE 230V SOLENOID VALVE 1/4"A TO SOLD 230V	AG60 G/CALDO	11/03/09 00/00/00	●
VCC	936016	VASCHET.EVAP.ACQUA CONDENSA AR EN1-2 TRAY EVAP. WATER CONDENSATE AR EN1-2	EN • AG60	31/07/00 00/00/00	
VCC1	996419	ASS.VASCHETTA UMID.LIEVITAMATIC EN EN LIEVITAMATIC TRAY TO COLLECT HUMIDITY	AL • AS	21/02/02 00/00/00	
VE	995678	VALV.TERMOSTAT.'TMV'+15/-30 R134A THERMOSTAT VALVE 'TMV'+15/-30 R134A	AR-EN -P • AL-EN -P	29/11/00 04/04/04	
	996205	VALV.TN2 68Z3384 ODF -40+10 S/MOP R13 VALVE TN2 68Z3384 ODF -40+10 S/MOP R13		05/04/04 00/00/00	
VE	995771	VALV.TERMOSTATICA'TMV'(MOP-18)R404 THERMOSTATIC VALVE 'TMV'(MOP-18)R404	AF-EN2 SUPER • AL-EN SUPER • AF- EN2 -P	15/02/01 04/04/04	
	996206	VALVOLA TERMOSTATICA TS2 R404A SILDARE THERMOSTATIC VALVE TS2 R404A TO SOLD		05/04/04 00/00/00	
VE	996206	VALVOLA TERMOSTATICA TS2 R404A SILDARE THERMOSTATIC VALVE TS2 R404A TO SOLD	AF-EN1 -P • AG60 SILVER -P	05/04/04 00/00/00	
VE	996257	VALV.TS2 68Z3435 ODF -40+10 VALVE TS2 68Z3435 ODF -40+10	AL-EN2 SUPER	26/06/07 00/00/00	
VEC	935951	VASCHETTA RACC.COND.AR SILVER/AR EN CONDENSATE WATER TRAY EN/SILVER CABINETS	AG60 ARIA/ACQUA	07/06/00 00/00/00	
VEC	935951	VASCHETTA RACC.COND.AR SILVER/AR EN CONDENSATE WATER TRAY EN/SILVER CABINETS	EN • ARP-EN2 • AL • AG60 • AS	07/06/00 03/11/08	
	935030	VASCHETTA RACC.COND.AR EN MODIF.VE ASS CONDENSATE WATER TRAY EN CAB. MODIF.		04/11/08 00/00/00	
VEC	936032	VASCHETTA INOX EVAP.AR EN2 SUPER INOX TRAY EVAP. AR EN2 SUPER	AF-EN2 SUPER	08/05/01 00/00/00	
VP	995492	VALVOLA PRESSOSTATICA DA 3/8 ACQUA PRESSURE VALVE 3/8 WATER	EN_H2O • AG60 H2O	01/01/95 00/00/00	
XB	965526	MORSETTO PHOENIX MSTB 2,5/3-ST PAS=5 PHOENIX TERMINAL MSTB 2,5/3-ST PAS=5	AR-EN1 GOLD • AG60 GOLD	_/_/_ 00/00/00	
W	995340	LAMPADA NEON DA 36W L=1200 NEON LAMP 36W L=1200	EN_VTR	28/11/02 31/12/08	
WL/S	997024	KIT DX FERM.+LED PORTA AR EN RIGHT GLAZING BEAD+LED DOOR KIT EN CAB.	EN_VTR	01/01/09 00/00/00	
WL/S	997025	KIT SX FERM.+LED PORTA AR EN LEFT GLAZING BEAD+LED DOOR KIT EN CAB.	EN1_VTR	01/01/09 00/00/00	