

**EN · ARP · AL · AG60 · AS · RIL**

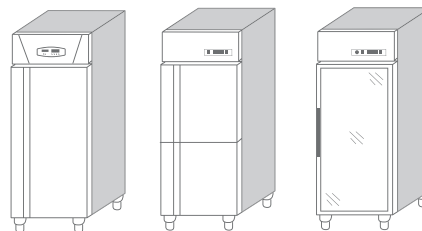

**IT**

**ARMADI EURONORM**  
per pasticceria

**GB**

**EURONORM CABINETS**  
for pastry

**DE**

**SCHRÄNKE EURONORM**  
für Gebäck

**FR**

**ARMOIRES EURONORM**  
pour pâtisserie

**ES**

**GABINETES EURONORM**  
para pasteleria

**PT**

**GABINETES EURONORM**  
para pasteleria

**GR**

**ΕΡΜΑΡΙΑ EURONORM**  
ζαχαροπλαστικής

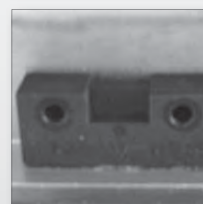

ESB0111EJ

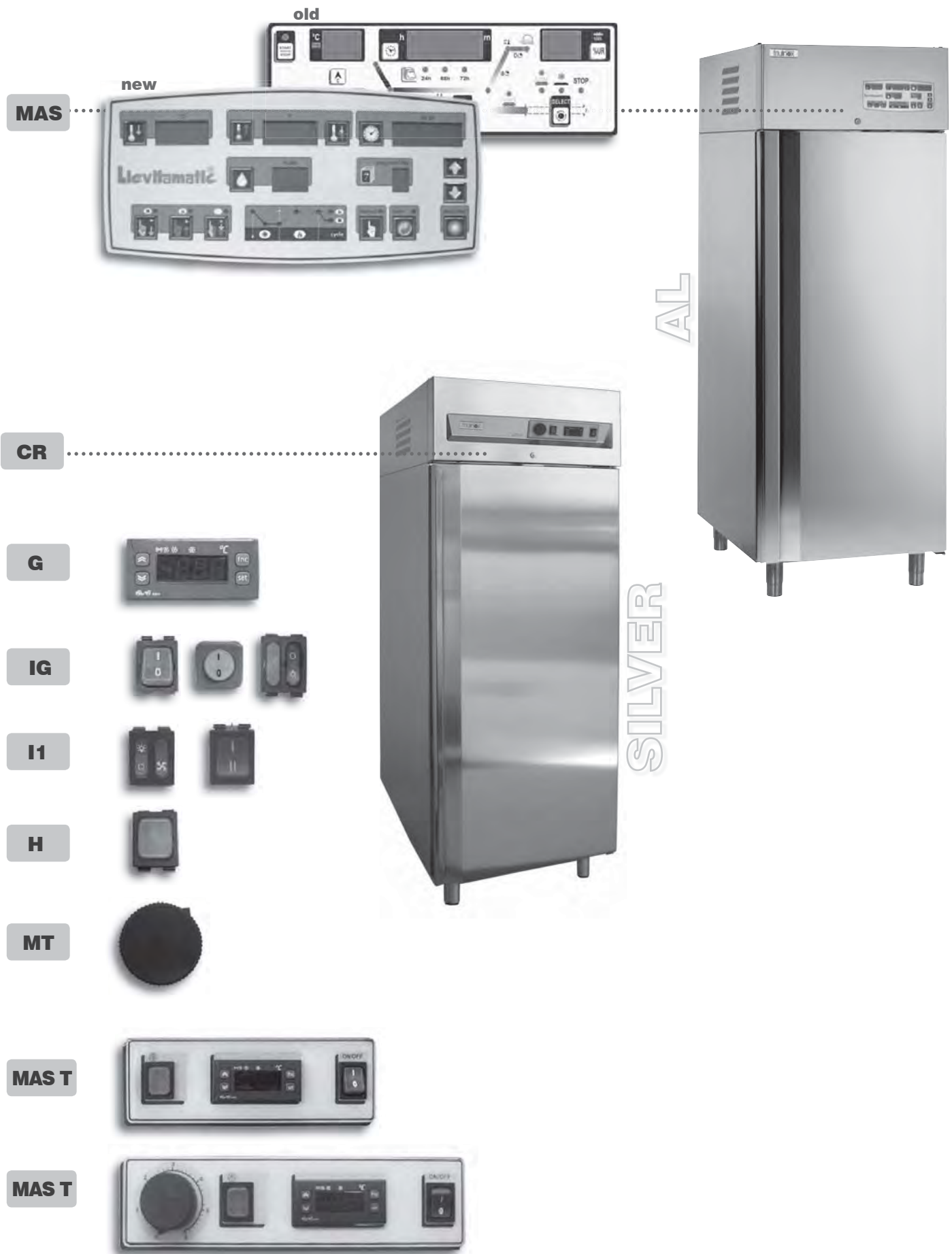

AS



GOLD

CR

pag.6



G1

G1+G2



G2



BF



FRI



FRE



MAS

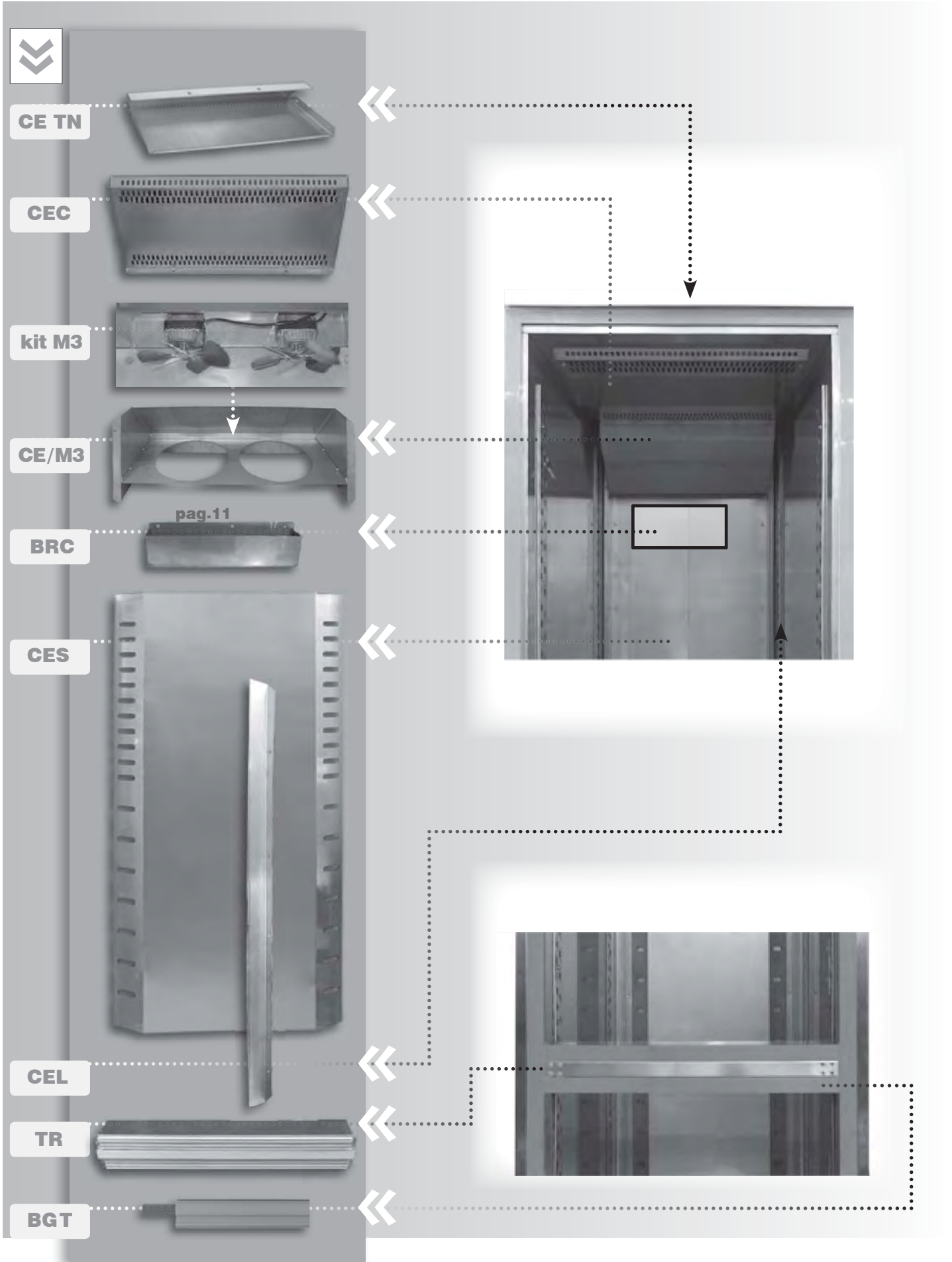

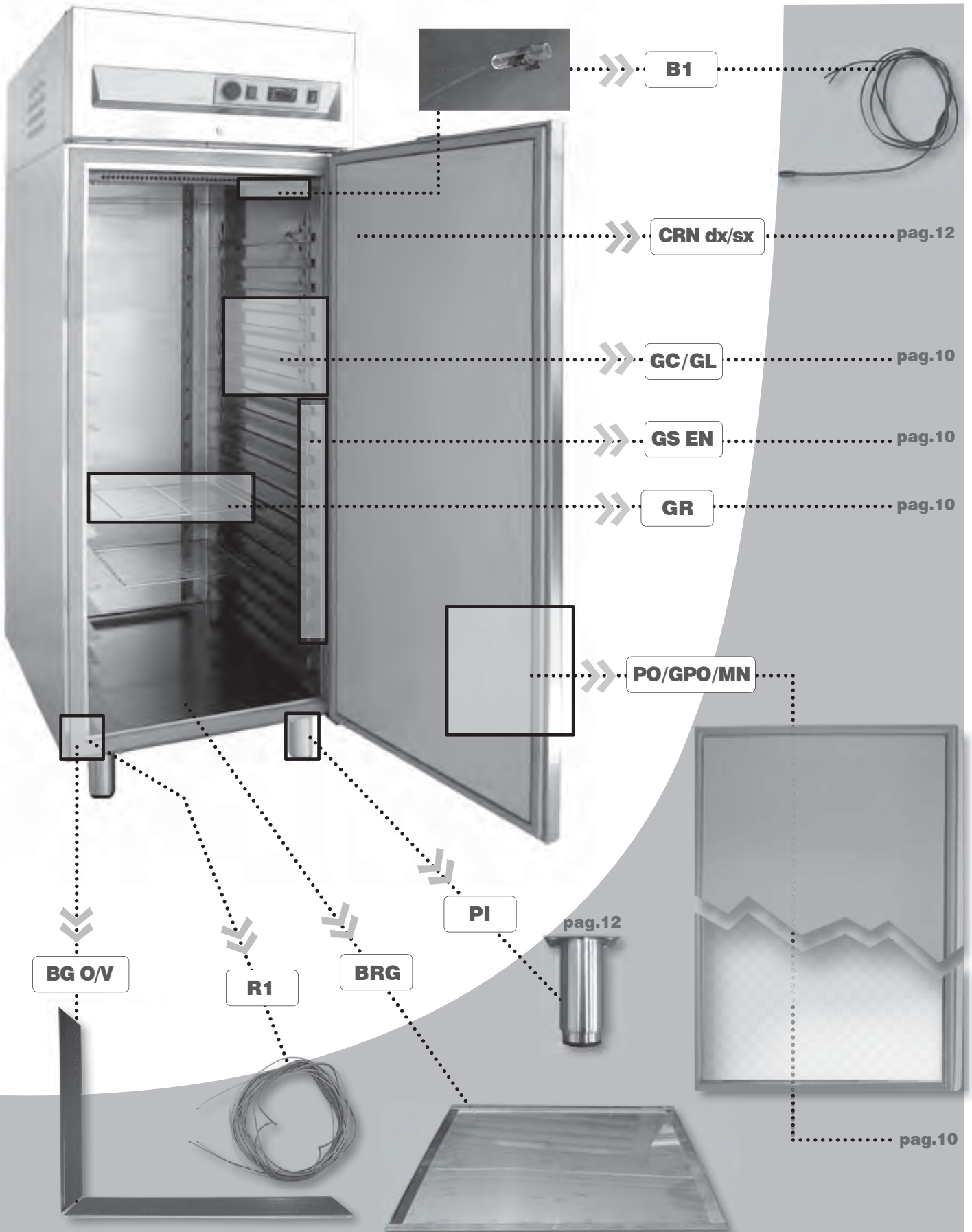

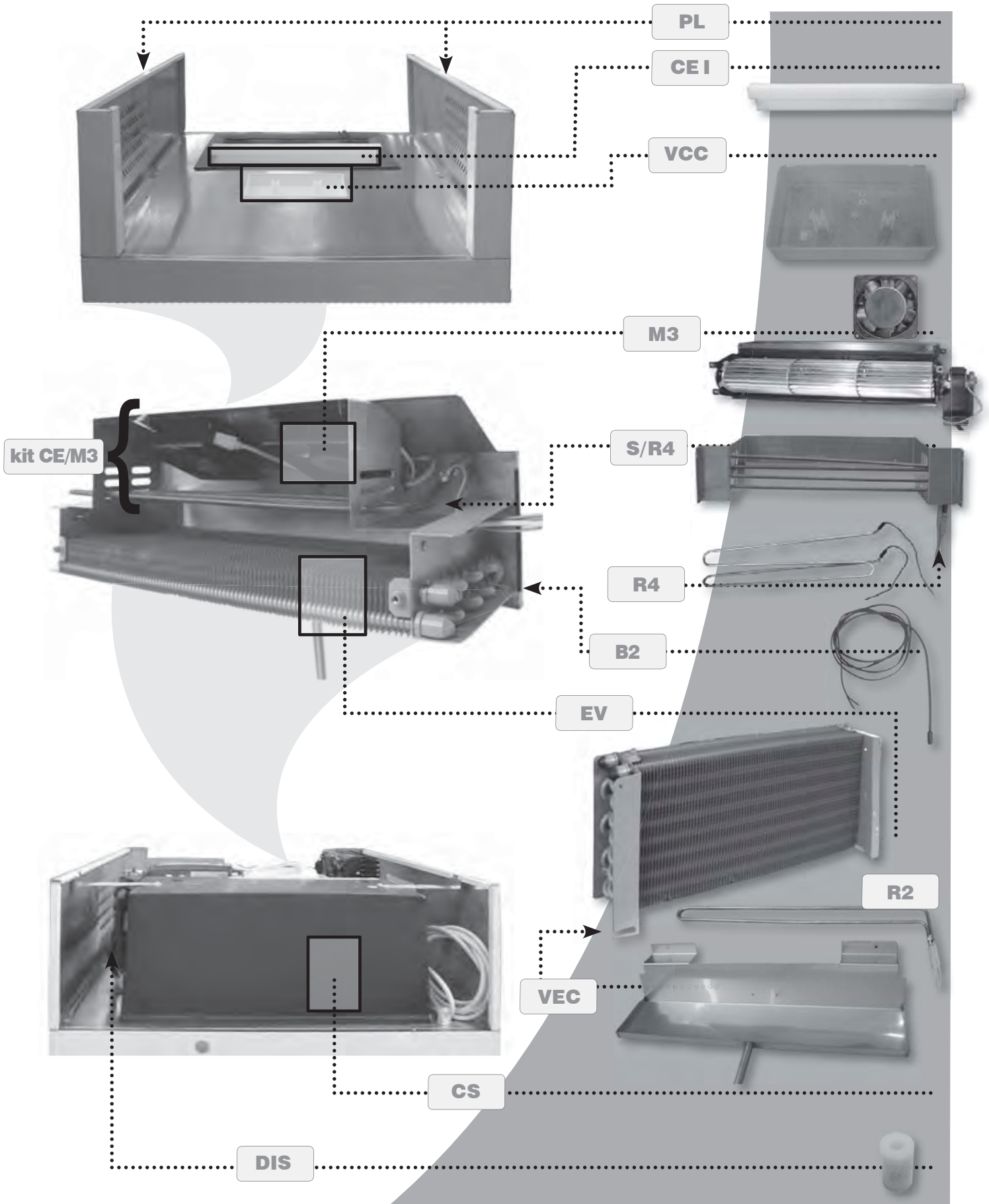

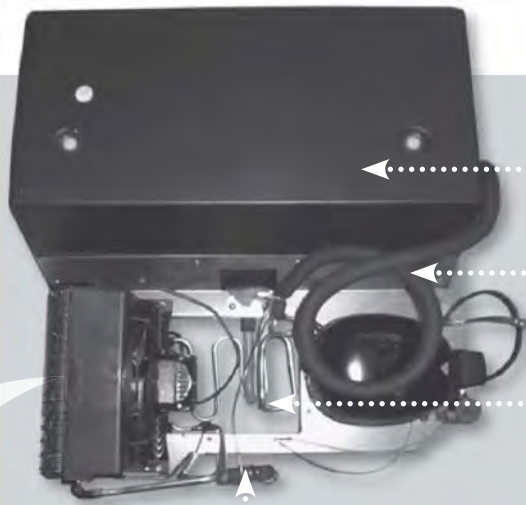

**CS**

**TS**

**TEC**

**F**

**kit M2**

**M1**

**BOX/M1**

**Q**

**C/M1**

**BV+V1**

**VE**

**OR**

**BVE**

**PVE**

**F**

**RL**

**GPV**

**M4**

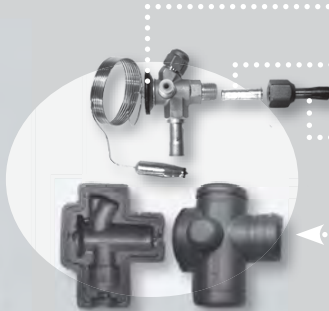

**SCE** pag.6

**SCE/C**

**CRN CR** pag.12

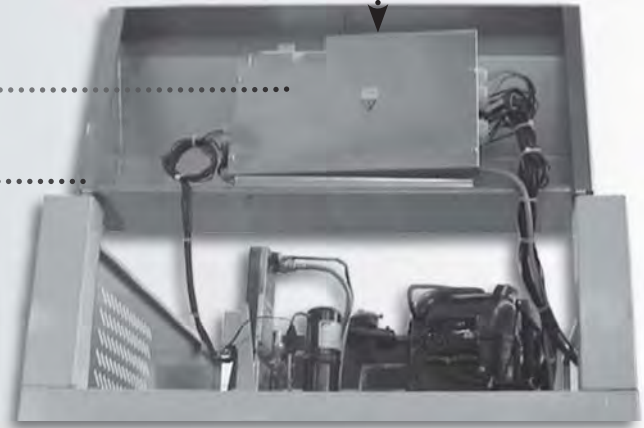

**kit CO H2O**

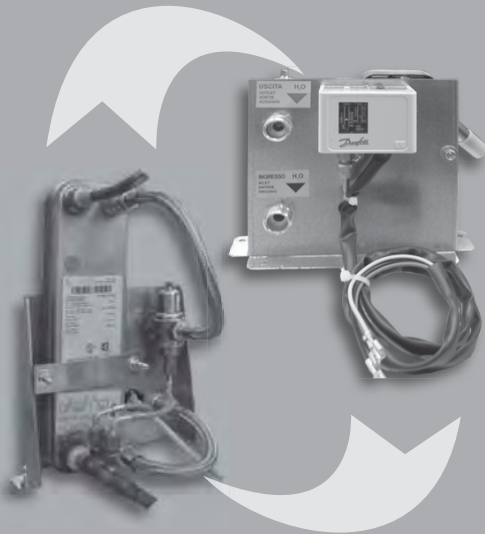

**CO H2O**

**VP**

**TG**

**P**

**M2**

**GPV**



pag.10

I3

PC G

Q1

T

SCE

Q1

G2

G1

G3

CV/E

A

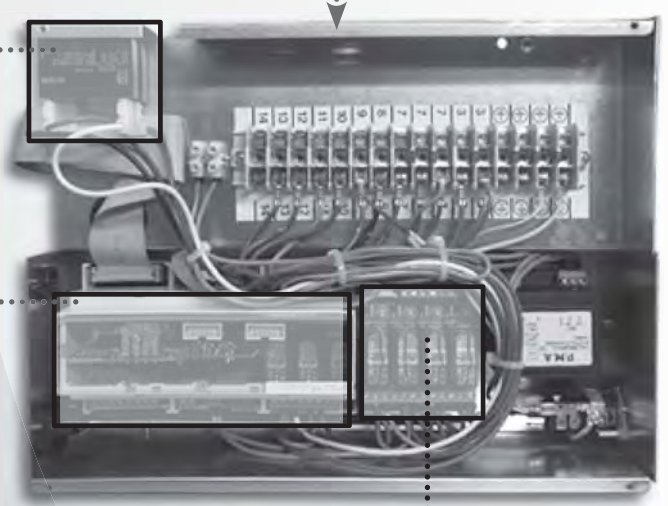
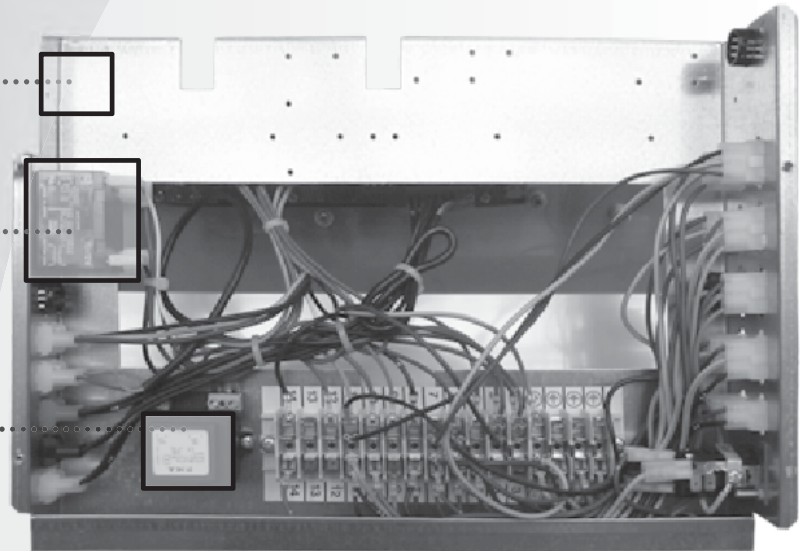
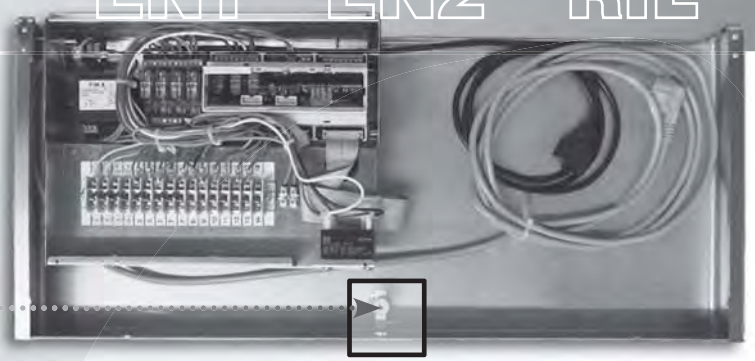

AL-RIL



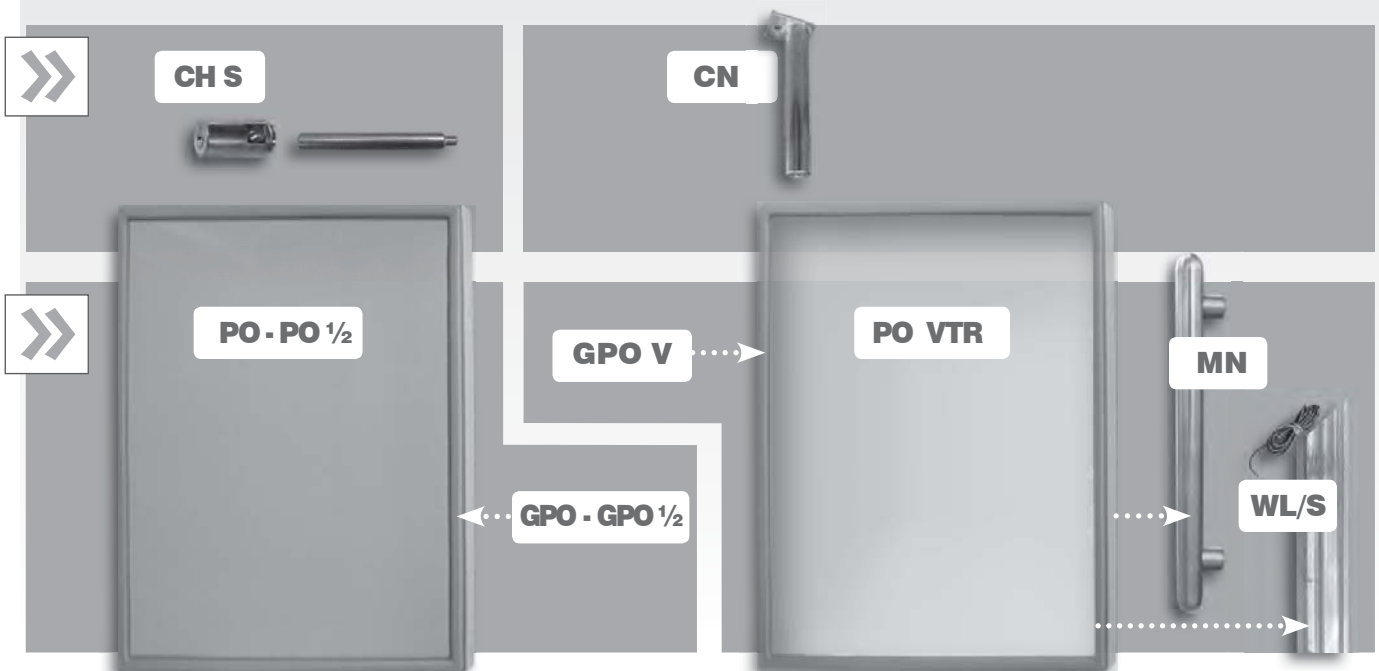
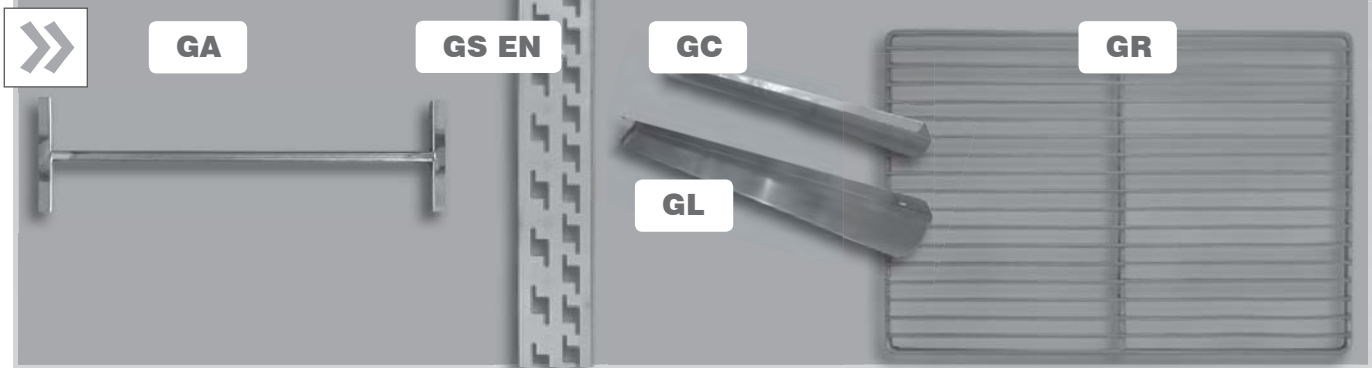



R3

CIA

B6

LL

VCC1

R3



AL-AS-RIL



R4

TSC

R6

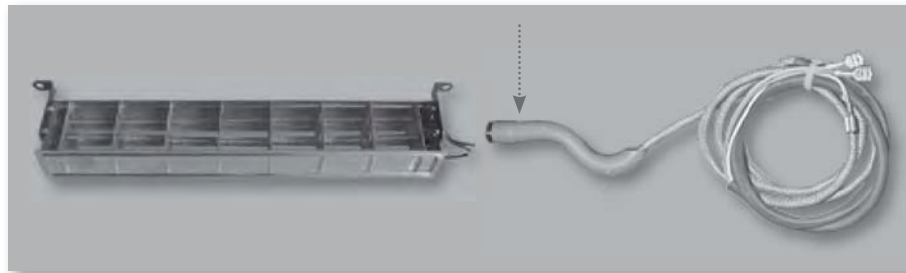

S

W

T2



FA

GA

CM1

CM2

CM3

CM4

CM5

XB

BO3

BO1



CA

TAI



RP

E

O



**CRN dx/sx**

**CRN1 dx/sx**

**CRN2 dx/sx**

**CRN 4**

**CRN3 dx/sx**

**CRN1 dx/sx**

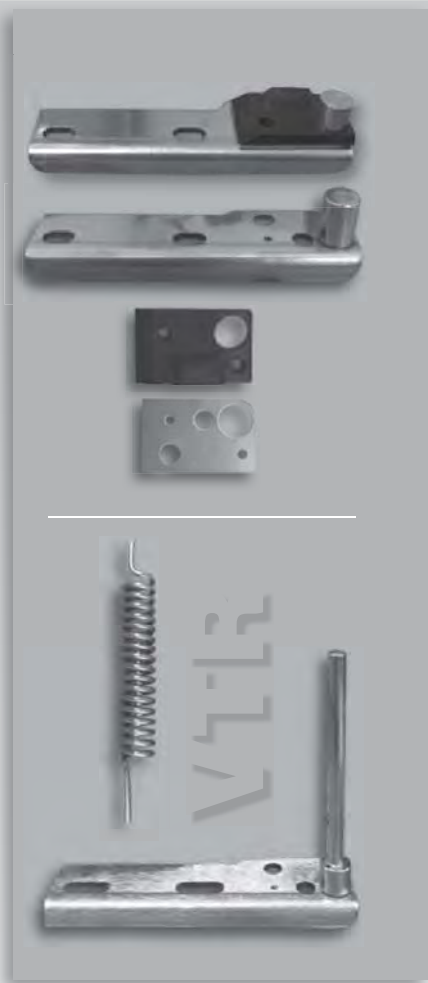

**CRNS dx/sx**

**CRN1 dx/sx**

**CRN3 dx/sx**

**CRNS**

**BO/PO**



**PI 1**

**PI 2**

**PI 4**



**PRR 3**

**PRR 4**



**CRN 1/2 dx/sx**

**CRN3 dx/sx**

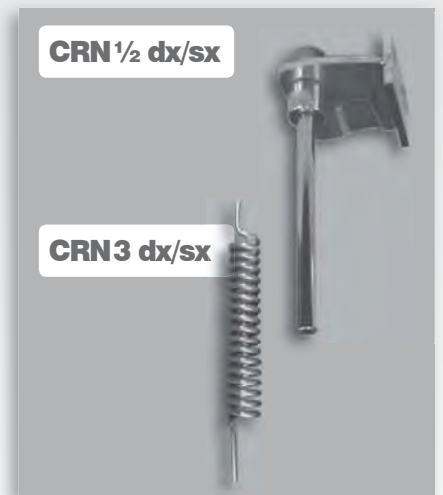

**CRN CR**



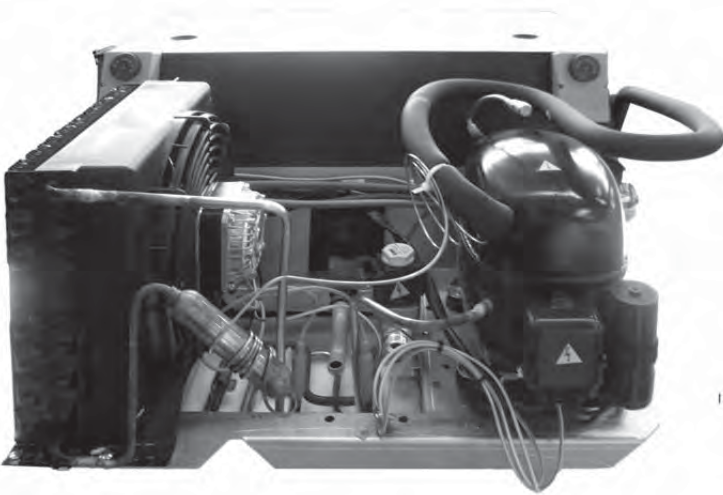
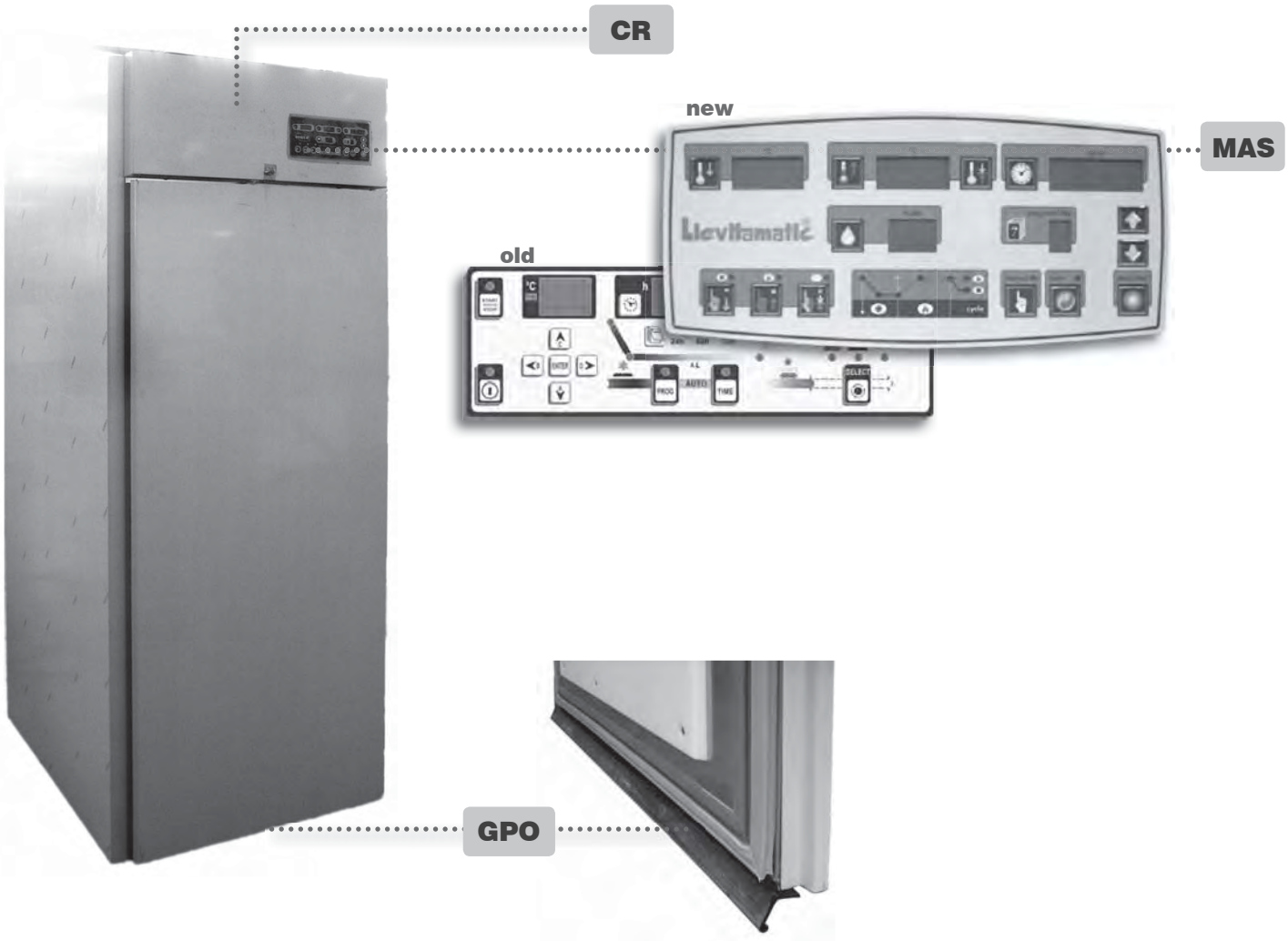

pag.7

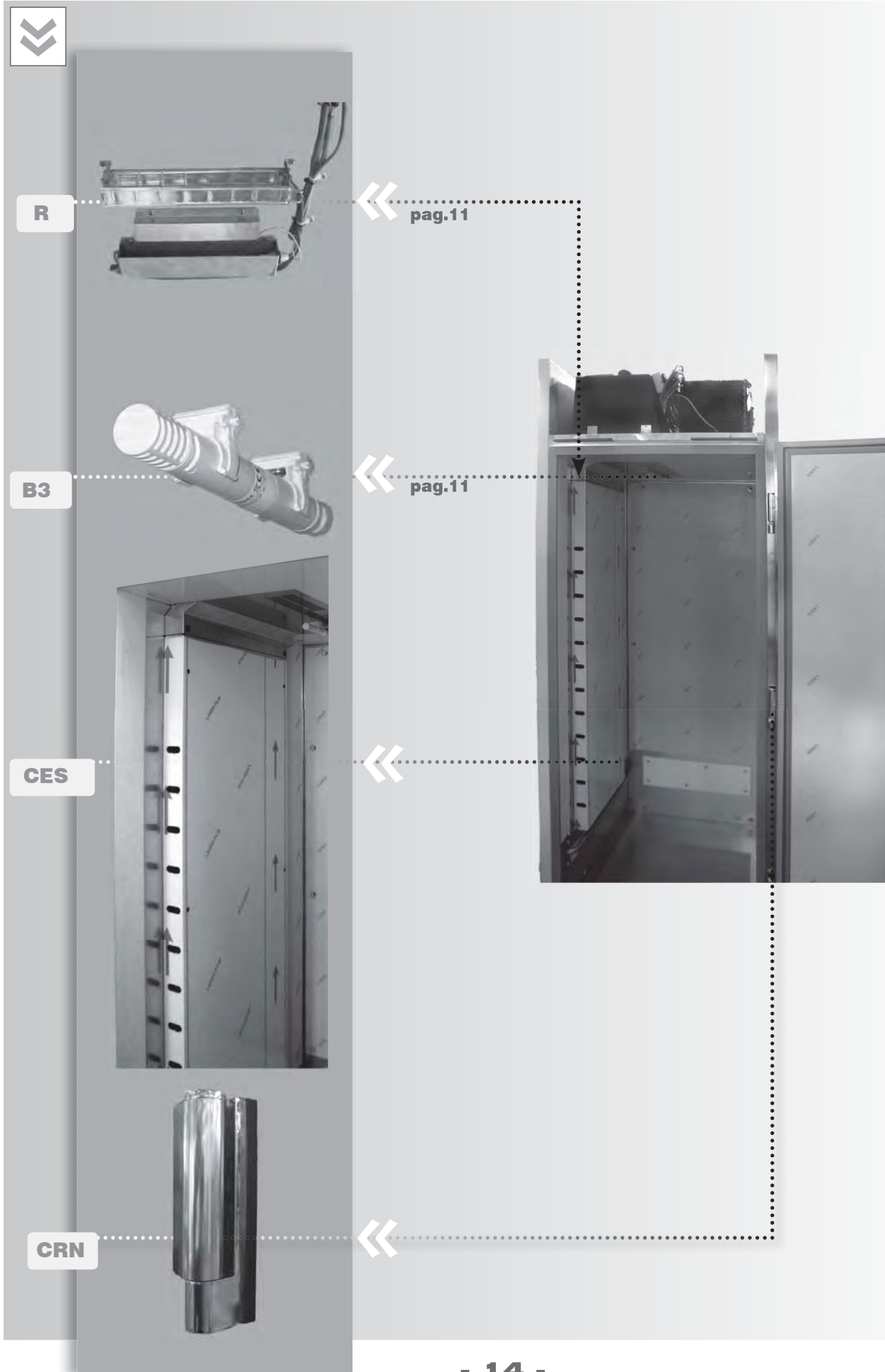

referim. reference	codice code	descrizione description	modello model	da...a from...to	ricambi cons. rec. spare part
<b>A</b>	<b>996901</b>	ALIMENTATORE 220-240V AC 24V DC 30W POWER SUPPLY UNIT 220-240V AC 24V DC 30W	<b>AS_VTR</b>	06/10/09 00/00/00	
<b>AG</b>	<b>990031</b>	ASTA GANCIERA MOBILE AR L530 INOX SLADING HANGING RAIL SEAS. CAB. L530 INOX	<b>AS</b>	01/01/95 00/00/00	
<b>B1</b>	<b>995562</b>	SONDA PTC GRIGIA SILICONATA L=2500 CELLA PTC PROBE, GREY SILICONED L=2500 CABINET	<b>AL</b>	01/01/95 00/00/00	●
<b>B2</b>	<b>995500</b>	SONDA PTC ROSSA SILICONATA L=2500 EVAP. PTC PROBE, RED SILICONED L=2500 EVAPOR.	<b>AL</b>	01/01/95 00/00/00	●
<b>B1 / B2</b>	<b>935886</b>	SONDA NTC CAVOTPE SN691150 L=2,5+TER.F NTC CAVOTPE PROBE SN691150 L=2,5+TER.F	<b>EN GOLD ● ARP ● AG60 GOLD ● AS</b>	22/11/04 00/00/00	●
<b>B6</b>	<b>935187</b>	SONDA UMIDITA' EVHP503 STAGIONATORE HUMIDITY PROBE EVHP503 SEASONER CABINET	<b>ARP ● AL ● AS</b>	05/02/09 00/00/00	●
<b>BF</b>	<b>936051</b>	BICCHIERINO DI FISSAGGIO FRONT.IRIDIUM RUBBER FIXING IRIIDIUM FRONTAL PANEL	<b>EN GOLD ● ARP ● AG60 GOLD ● AS</b>	//_/_ 00/00/00	
<b>BG O</b>	<b>996463</b>	PROF.MOB.L=712 ORIZ.BAT.GUARN.AR EN HOR. EXT.PROFILE FOR RABBET L=712 EN CAB.	<b>EN ● AG60 ● AS</b>	01/01/95 12/11/08	
	<b>935034</b>	BATTUTA GUARNIZIONE ORIZ. L=687 C/MAGN. HORIZONTAL PROF. FOR RABBET L=687 + MAGN.		13/11/08 00/00/00	
<b>BG T</b>	<b>936001</b>	PROFILO L=644 ORIZZ.BATT.GUARN.EN HOR. EXT.PROFILE FOR RABBET L=644 EN CAB.	<b>EN ● AG60</b>	01/12/99 06/10/08	
	<b>935035</b>	BATT. GUARNIZ. TRAVERSA AR EN NEW L=621 PR. FOR CROS.PANEL RABBET L=621 EN NEW RC		07/10/08 00/00/00	
<b>BG V</b>	<b>936000</b>	PROFILO L=1575 VERT.BATT.GUARN.P.1/2 VERT. EXT. PROF. FOR RABBET L=1575 1/2 DOOR	<b>EN ● AG60</b>	01/01/95 13/11/08	
	<b>935036</b>	BATTUTA GUARNIZIONE VERT. L=1542 C/MAG. VERT.EXT.PROF. FOR RABBET L=1542 P0607 1/2D.		14/11/08 00/00/00	
<b>BG V</b>	<b>996464</b>	PROF.MOB.L=1575 VERT.BATT.GUA.AR EN VERT. EXT. PROF. FOR RABBET L=1575 EN CAB.	<b>EN ● AS</b>	01/01/95 12/11/08	
	<b>935036</b>	AB07 PROF.COPBATT.GU.L=1542 P0607 C/MA VERT.EXT.PROF. FOR RABBET L=1542 P0607 C/M		13/11/08 00/00/00	
<b>BO 1</b>	<b>936038</b>	BOCCOLA PASSACAVO D=08 BUSH D=08	<b>EN ● AG60 ● AS</b>	//_/_ 00/00/00	
<b>BO 3</b>	<b>936038</b>	BOCCOLA PASSACAVO D=14 BUSH D=14	<b>EN2 ● AG60 ● AS</b>	//_/_ 00/00/00	
<b>BO/PO</b>	<b>935976</b>	BOCCOLA PORTA VETRO STAR-EN-PLANET DOOR BUSH STAR-EN-PLANET	<b>EN_VTR</b>	//_/_ 00/00/00	
<b>BOX/M1</b>	<b>996025</b>	BOX ELETTRICO DANFOSS '117-7012' ELECTRIC BOX DANFOSS '117-7012'	<b>&gt; 995770</b>	22/05/00 00/00/00	
<b>BRG</b>	<b>935188</b>	BACINELLA GOCCIOLATOIO AR STAGIONATORE DRIPPING TRAY FOR SEASONER CABINET	<b>AS</b>	05/02/09 00/00/00	
<b>BV</b>	<b>996182</b>	BOBINA HM2 230V 50/60HZ X VALVOLA SOLE COIL HM2 230V 50/60HZ FOR SOLENOID VALVE	<b>AL ● AG60 G/CALDO ● AS</b>	16/03/04 00/00/00	
<b>BVE</b>	<b>996539</b>	ADATTATORE VALV.ODF 6MM 68-2063 DANFOS VALVE ADAPETER ODF 6MM 68-2063 DANFOS	<b>-P</b>	13/07/05 00/00/00	
<b>C/M1</b>	<b>996749</b>	CONDENSATORE EL.DANFOSS '117U5012' ELECTRIC CONDENSER DANFOSS '117U5012'	<b>&gt; 995746</b>	11/06/08 00/00/00	
<b>C/M1</b>	<b>996023</b>	CONDENSATORE EL. DANFOSS '117U5015' ELECTRIC CONDENSER DANFOSS '117U5015'	<b>&gt; 996353 &gt; 995742</b>	01/06/07 00/00/00	
<b>C/M1</b>	<b>996024</b>	CONDENSATORE EL. DANFOSS '117U5017' ELECTRIC CONDENSER DANFOSS '117U5017'	<b>&gt; 996725 &gt; 995983 &gt; 995743 &gt; 995747</b>	11/06/08 00/00/00	
<b>C/M1</b>	<b>996550</b>	CONDENSATORE EL. DANFOSS '117U5018' ELECTRIC CONDENSER DANFOSS '117U5018'	<b>&gt; 996354 &gt; 996355</b>	01/06/07 00/00/00	
<b>CA</b>	<b>995420</b>	CAVO ALIMENTAZIONE AR-TR SCHUCO ELECTRIC SUPPLY CABLE AR-TR SCHUCO	<b>EN ● AG60 ● AS</b>	29/05/03 00/00/00	
<b>CE I</b>	<b>936031</b>	PROF.ISO.31X30X560 ANTER.SUPP.VASCH.EV INSUL. PROF. 31X30X560 TO SUPP. EVAP. TRAY	<b>EN ● AG60 ● AS</b>	13/09/00 00/00/00	
<b>CE TN</b>	<b>936028</b>	TRAVERSA DIVISORIA PER CIELO AR EN PARTITION CROSS FRAME FOR CEILING EN CAB.	<b>EN ● AG60 ● AS</b>	//_/_ 00/00/00	
<b>CE TN</b>	<b>936052</b>	TRAVERSA DIVISORIA AREN CROSSBEAN HALF DOOR AR EN	<b>AF-EN2_SUPER SILVER</b>	16/02/01 00/00/00	
<b>CE/M2</b>	<b>995759</b>	CONVOGLIATORE CONDENS. STVF 124/194 CONDENSER CONVEYOR STVF 124/194	<b>&gt; 995523</b>	08/04/03 00/00/00	
<b>CE/M2</b>	<b>995775</b>	CONVOGLIATORE CONDENS. STVF 93/139 CONDENSER CONVEYOR STVF 93/139	<b>&gt; 995522 &gt; 995524</b>	08/04/03 00/00/00	
<b>CE/M2</b>	<b>996162</b>	CONVOGLIATORE CF33 COND.LUVE STVF273 CONVEYOR CF33 COND. LUVE STVF273	<b>&gt; 995908</b>	08/04/03 00/00/00	
<b>CE/M3</b>	<b>935632</b>	ASS.CONVOGLIATORE VENT.AR EN SUPER FAN CONVEYOR ASS. EN SUPER CABINETS	<b>AF-EN2 SUPER ● AF-EN2_VTR ICE</b>	16/02/01 00/00/00	

referim. reference	codice code	descrizione description	modello model	da...a from...to	ricambi cons. rec. spare part
<b>CEC</b>	<b>935627</b>	CONVOGLIATORE CIELO AR EN1 CEILING CONVEYOR EN2 CABINET	<b>EN1</b>	13/12/99 00/00/00	
<b>CEC</b>	<b>935628</b>	CONVOGLIATORE CIELO AR EN2 CEILING CONVEYOR EN2 CABINET	<b>EN2 • AS</b>	_/_/_ 00/00/00	
<b>CEC</b>	<b>935631</b>	CONVOGL. CIELO AR EN SUPER CEILING CONVEYOR EN SUPER CABINET	<b>AF-EN2 SUPER</b>	13/12/99 00/00/00	
<b>CEC</b>	<b>936644</b>	CONVOGLIATORE CIELO AR EN GELATO CEILING CONVEYOR EN ICE CABINET	<b>AG60</b>	20/05/08 00/00/00	
<b>CEL</b>	<b>935637</b>	SPALLA CONV. ARIA AR EN BACK SIDE CONVEYOR EN CABINETS	<b>AF-EN2_SUPER SILVER</b>	_/_/_ 00/00/00	
<b>CES</b>	<b>935629</b>	CONVOGLIATORE SCHIENALE AR EN BACK CONVEYOR EN CABINET	<b>EN</b>	10/01/00 00/00/00	
<b>CES</b>	<b>936647</b>	CONVOGLIATORE SCHIENALE AR EN GELATO BACK CONVEYOR EN ICE CABINET	<b>AG60</b>	20/05/08 00/00/00	
<b>CES</b>	<b>935189</b>	CONVOGL. SCHIENALE AR EN STAGIONATORE BACK CONVEYOR EN SEASONER CABINET	<b>AS</b>	05/02/09 00/00/00	
<b>CH</b>	<b>925337</b>	COPPIA CHIAVI PORTA TR GOLD 'INOX' PAIR OF KEYS FOR DOOR TR GOLD 'INOX'	<b>EN • AG60 • AS</b>	16/06/06 00/00/00	
<b>CH CR</b>	<b>935400</b>	SERRATURA A CHIAVE X AR MNSC/22 LOCKING DOOR KEY FOR MNSC/22 CABINETS	<b>EN • AG60 • AS</b>	01/01/95 00/00/00	
<b>CH S</b>	<b>925807</b>	SERRATURA A PALETTO + PERNO TR H=650 N SHAFT-TYPE LOCK. DOOR + PIN H=650 TR NEW	<b>EN GOLD</b>	08/11/04 00/00/00	
<b>CIA</b>	<b>925694</b>	CAPILL. XINIEZ. H2O D=1,24X150 INJECTION WATER CAPILLARY D=1,24X150	<b>AL • AS</b>	06/09/06 00/00/00	
<b>CM1</b>	<b>936038</b>	CONNETTORE MTL MASC. 2 POLI NERO EDGE CONNECTOR MTL 2 POLES BLACK	<b>EN GOLD • ARP • AG60 GOLD • AS</b>	23/06/04 00/00/00	
<b>CM2</b>	<b>936037</b>	CONNETTORE MTL MASC. 2 POLI BIANCO EDGE CONNECTOR MTL 2 POLES WHITE	<b>EN GOLD • ARP • AG60 GOLD • AS</b>	19/06/03 00/00/00	
<b>CM3</b>	<b>936039</b>	CONNETTORE MTL MASC. 2 POLI ROSSO EDGE CONNECTOR MTL 2 POLES RED	<b>EN GOLD • ARP • AG60 GOLD • AS</b>	19/11/04 00/00/00	
<b>CM4</b>	<b>936040</b>	CONNETTORE MTL MASC. 3 POLI NERO EDGE CONNECTOR MTL 3 POLES BLACK	<b>EN GOLD • ARP • AG60 GOLD • AS</b>	29/11/04 00/00/00	
<b>CM5</b>	<b>936036</b>	CONNETTORE MTL MASC. 3 POLI BIANCO EDGE CONNECTOR MTL 3 POLES WHITE	<b>EN GOLD • ARP • AG60 GOLD • AS</b>	29/11/04 00/00/00	
<b>CN</b>	<b>935319</b>	CANOTTO INOX AR MNSCOCCA PORTEVETRO INOX TUBE FOR MNCQ CABINETS GLASS-DOOR	<b>EN_VTR • AS_VTR</b>	28/11/02 00/00/00	
<b>CN</b>	<b>935723</b>	CANNOTTO IN PLASTICA SUP. DX UPPER RIGHT PLASTIC TUBE	<b>EN • AG60 • AS</b>	15/10/08 00/00/00	
<b>CN</b>	<b>935724</b>	CANNOTTO IN PLASTICA INF. DX UPPER LEFT PLASTIC TUBE	<b>EN • AG60 • AS</b>	15/10/08 00/00/00	
<b>CO</b>	<b>995522</b>	CONDENSATORE STVF 139 CONV RINF C/CURV STVF 139 CONDENSER	<b>AF-EN1 • AL-EN1_SUPER • AR-EN2 • ARP-EN2 • AL-EN2 • AS</b>	01/01/95 00/00/00	
<b>CO</b>	<b>995523</b>	CONDENSATORE STVF 194 CONV RINF C/CURV STVF 194 CONDENSER	<b>AF-EN2 • AL-EN2 SUPER • AG60 GOLD</b>	01/01/95 00/00/00	
<b>CO</b>	<b>995524</b>	CONDENSATORE STVF 93 CONV RINF C/CURV STVF 93 CONDENSER	<b>AR-EN1 • ARP-EN1 • AL-EN1 • AG60 SILVER</b>	01/01/95 00/00/00	
<b>CO H2O</b>	<b>995909</b>	CONDENSATORE H2O SALDOBR. ZC207 10 PIA WATER CONDENSER BRAZED ZC207 10 PLATES	<b>EN_H2O • AG60 H2O</b>	13/06/05 00/00/00	
<b>CR</b>	<b>935648</b>	ASS. CRUSCOTTO BT AR EN1/EN2 FRONTAL PANEL BT EN1/EN2 CABINETS	<b>AF-EN SILVER</b>	01/01/95 09/11/08	
	<b>935066</b>	ASS. CRUSCOTTO BT AR EN1/EN2 NEW FRONTAL PANEL BT EN1/EN2 NEW CABINETS		10/11/08 00/00/00	
<b>CR</b>	<b>935651</b>	ASS. CRUSCOTTO TN AR EN1/EN2 FRONTAL PANEL TN EN1/EN2 CABINETS	<b>AR-EN SILVER</b>	01/01/95 19/10/08	
	<b>935068</b>	ASS. CRUSCOTTO TN AR EN1/EN2 NEW FRONTAL PANEL TN EN1/EN2 NEW CABINETS		20/10/08 00/00/00	
<b>CR</b>	<b>996363</b>	ASS. CRUSCOTTO ARMADI EN VERS. IRIIDIUM FRONTAL PANEL EN CABINETS IRIIDIUM	<b>AR-EN GOLD • AF-EN GOLD • ARP • AG60 GOLD • AS</b>	01/01/95 12/11/08	
	<b>935069</b>	ASS. CRUSCOTTO AR EN VER. IRIIDIUM NEW FRONTAL PANEL EN CABINETS IRIIDIUM NEW		13/11/08 00/00/00	
<b>CR</b>	<b>935678</b>	ASS. CRUSCOTTO AR EN2 LIEVITAMATIC FRONTAL PANEL EN2 CABINET LIEVITAMATIC	<b>AL</b>	01/01/95 12/11/08	
	<b>935070</b>	ASS. CRUSCOTTO AR EN LIEVITAMATIC NEW FRONTAL PANEL EN CABINET LIEVITAMATIC NEW		13/11/08 03/04/11	
	<b>615A591</b>	ASS. CRUSC. AR EN LIEVIT. SCH. FL08 FRX NEW FR. PANEL EN LIEVITAM. CAB. FL08 CARD FRX		04/04/11 00/00/00	
<b>CR</b>	<b>936653</b>	ASS. CRUSCOTTO BT AR EN GELATO FRONTAL PANEL EN BT CABINET ICE	<b>AG60 SILVER</b>	20/05/08 00/00/00	



referim. reference	codice code	descrizione description	modello model	da...a from...to	ricambi cons. rec. spare part
<b>CRN dx</b>	<b>935316</b>	CERNIERA INFERIORE'DX'AR MNSC P/VET LOWER RIGHT HINGE AR MNSC GLASS DOOR	EN • AG60	01/01/95 00/00/00	
<b>CRN sx</b>	<b>935317</b>	CERNIERA INFERIORE'SX'AR MNSC P/VET LOWER LEFT HINGE AR MNSC GLASS DOOR	EN • AG60	01/01/95 00/00/00	
<b>CRN1/2 dx</b>	<b>935644</b>	ASS.CERNIERA 1/2 P DX AR EN RIGHT HINGE FOR HALF DOOR EN CABINETS	EN • AG60	01/12/99 31/12/07	
	<b>935834</b>	ASS.CERN.PORTA 1/2 DX AR STAR RIGHT HINGE FOR HALF DOOR STAR CABINETS		01/01/08 00/00/00	
<b>CRN1/2 sx</b>	<b>935645</b>	ASS.CERNIERA 1/2 P SX AR EN LEFT HINGE FOR HALF DOOR EN CABINETS	EN • AG60	01/12/99 31/12/07	
	<b>935833</b>	ASS.CERN.PORTA 1/2 SX AR STAR LEFT HINGE FOR HALF DOOR STAR CABINETS		01/01/08 00/00/00	
<b>CRN 1</b>	<b>935316</b>	CERNIERA INFERIORE DX AR MNSC P/VET LOWER RIGHT HINGE MNCQ CAB. GLASS DOOR	AG60	__ 00/00/00	
<b>CRN 1 dx</b>	<b>936002</b>	ASS.CERNIERA INF.DX PORTE VTR.AR/EN MN LOWER RIGHT HINGE ASS. GLASSES DOOR AR EN	EN	20/09/07 00/00/00	
<b>CRN 1 sx</b>	<b>965663</b>	ASS.CERNIERA INF.SX PORTE VTR.MNSC-AR LOWER LEFT HINGE ASS. GLASSES DOOR AR EN	EN • AG60	29/11/07 00/00/00	
<b>CRN 1V dx</b>	<b>935975</b>	STAFFA CERN.INFER DX AR VTR STAR-EN LOWER RIGHT HINGE GLASS DOOR STAR-EN C.	EN_VTR • AS_VTR	16/05/07 00/00/00	
<b>CRN 1V sx</b>	<b>935981</b>	STAFFA CERN.INFER SX AR VTR STAR-EN LOWER LEFT HINGE GLASSES DOOR STAR-EN C.	EN_VTR • AS_VTR	16/05/07 00/00/00	
<b>CRN 2 dx</b>	<b>935715</b>	PIASTRA FERMO PORTA 'DX'PV'AR MNSC RIGHT LOCKING DOOR PLATE 'PV'AR MNSC	EN • AG60 • AS	19/09/03 00/00/00	
<b>CRN 2 sx</b>	<b>935714</b>	PIASTRA FERMO PORTA 'SX'PV'AR MNSC LEFT LOCKING DOOR PLATE 'PV'AR MNSC	EN • AG60 • AS	19/09/03 00/00/00	
<b>CRN 4</b>	<b>936009</b>	PIAST.PER CERNIERA INF. AR/AF EN2/STAR PLATE FOR LOWER HINGE AR/AF EN2/STAR	EN_VTR • AG60	18/10/07 00/00/00	
<b>kit CRN inv.</b>	<b>930096</b>	KIT INVE.DX-SX POR.VETRO AR-POR.CIECA FROM RIGHT-LEFT INVERS. DOOR & GLASS D. KIT	EN • EN_VTR	__ 00/00/00	
<b>kit CRN inv.</b>	<b>930205</b>	KIT INVE.SX-DX POR.VETRO AR-POR.CIECA FROM LEFT-RIGHT INV. DOOR	EN • AG60	__ 00/00/00	
<b>kit CRN 1/2 inv.</b>	<b>930210</b>	KIT INV.SX-DX 1/2 PORTE EN FROM LEFT-RIGHT INVERS. KIT HALF DOORS EN	EN • AG60	01/01/95 31/07/09	
<b>kit CRN 1/2 inv.</b>	<b>930201</b>	KIT INVER.DX-SX PORTA MEZZA AR EN FROM RIGHT-LEFT INV. HALF DOOR KIT EN CAB.	EN • AG60	__ 31/07/09	
	<b>930311</b>	KIT INV.1/2 PORTE DA DX A SX AR EN 2009 FROM RIGHT- LEFT INV. KIT X 1/2 DOOR EN C.		01/08/09 00/00/00	
<b>kit CRN 1/2V inv.</b>	<b>930202</b>	KIT INVER.DX-SX PORTA 1/2 VETRO GOLD FROM RIGHT-LEFT HALF GLASS DOOR KIT GOLD	EN_VTR	__ 00/00/00	
<b>CRNS dx</b>	<b>936011</b>	KIT CERNIERA SUPERIORE'DX'+MOLLA AR MN UPPER RIGHT HINGE + SPRING AR MNSC	EN • AG60	01/10/07 00/00/00	
<b>CRNS sx</b>	<b>936012</b>	KIT CERNIERA SUPERIORE'SX'+MOLLA AR MN UPPER LEFT HINGE + SPRING AR MNSC	EN • AG60	01/10/07 00/00/00	
<b>CRNS V</b>	<b>935071</b>	ASS. CERNIERA SUP. DX-SX PORTE VTR EN UPPER LEFT/RIGHT HINGE GLASSES DOOR EN	EN_VTR • AS_VTR	28/11/02 00/00/00	
<b>CRNS 1 dx</b>	<b>935314</b>	CERNIERA SUPERIORE'DX'AR MNSC P/VET UPPER RIGHT HINGE AR MNSC GLASSES DOOR	EN • AG60 • AS	01/01/95 00/00/00	
<b>CRNS 1 sx</b>	<b>935315</b>	CERNIERA SUPERIORE'SX'AR MNSC P/VET UPPER LEFT HINGE AR MNSC GLASSES DOOR	EN • AG60 • AS	01/01/95 00/00/00	
<b>CRN 3 dx</b>	<b>935057</b>	MOLLA PER PORTA DX ARMADI RIGHT SPRING FOR CABINET DOORS	EN	01/01/95 00/00/00	
<b>CRN 3 sx</b>	<b>935058</b>	MOLLA PER PORTA SX ARMADI LEFT SPRING FOR CABINET DOORS	EN	01/01/95 00/00/00	
<b>CRNS 3V dx</b>	<b>935696</b>	MOLLA PORTA DX ARMADI CANOTTO IN ABS RIGHT SPRING FOR CABINET DOORS ABS TUBE	EN_VTR • AG60 • AS_VTR	01/01/95 00/00/00	
<b>CRNS 3V sx</b>	<b>935697</b>	MOLLA PORTA SX ARMADI CANOTTO IN ABS LEFT SPRING FOR CABINET DOORS ABS TUBE	EN_VTR • AG60 • AS_VTR	01/01/95 00/00/00	
<b>CRN CR</b>	<b>936041</b>	CERNIERA BISCOTTO ACC.ZN .MM 15X100 HINGE FOR FR. PANEL GALV. STEEL MM 15X100	EN • AG60 • AS	01/01/95 00/00/00	
<b>CV/E</b>	<b>925862</b>	CABLAGGIO DOPPIO VENTIL.TF NEW L=2200 WIRING DOUBLE FAN TF NEW L=2200	AG60 • AL • AS	__ 00/00/00	
<b>CV/E</b>	<b>935072</b>	CABLAGGIO TERM. SICUR. AR FERMALIEVITA THERM. SAF.WIRING FOR CONTR. PROVING CAB.	EN1 H2O SILVER • AL • AS	16/03/04 00/00/00	
<b>CS</b>	<b>935650</b>	ASS.CUPOLA SCHIUM.AR SILVER/EN INSULATED DOME SILVER/EN CABINETS	EN • AG60 • AS	19/07/01 00/00/00	
<b>DIS</b>	<b>996503</b>	DISTANZIALE IN NYLON 6,3X15X25 DCK82 NYLON SPACER 6,3X15X25 DCK82	AG60 • AS	24/07/00 00/00/00	

referim. reference	codice code	descrizione description	modello model	da...a from...to	ricambi cons. rec. spare part
<b>DIS</b>	<b>996503</b>	DISTANZIALE IN NYLON 6,3X15X25 DCK82 NYLON SPACER 6,3X15X25 DCK82	EN1	24/07/00 12/11/08	
	<b>935073</b>	DISTANZIALE IN PLASTICA AR EN L=40 NYLON SPACER L=40 EN CABINETS		13/11/08 00/00/00	
<b>E</b>	<b>995574</b>	TERMOSTATO F2000 +30+90°C C.1500 THERMOSTAT F2000 +30+90°C C.1500	EN -P • AL • AG60 -P • AS	12/01/01 00/00/00	●
<b>EV</b>	<b>935611</b>	EVAPORATORE 2 RANGHI AR SILVER/EN EVAPORATOR 2 ROWS SILVER/EN CABINET	AR-EN1 • AF-EN1 • ARP-EN1 • AL-EN1	07/06/00 00/00/00	
<b>EV</b>	<b>935613</b>	EVAPORATORE 3 RANGHI AR SILVER/EN EVAPORATOR 3 ROWS SILVER/EN CABINET	AF-EN_VTR • AF-EN2 • AF-EN ICE • AR-EN2 • ARP-EN2 • AL-EN2 • AG60 • AS	12/07/01 00/00/00	
<b>EV</b>	<b>935615</b>	EVAP.36 TUBI PASSO DIFF. AR SILVER/EN EVAPORATOR 36 TUBES SILVER/EN CABINETS	AF-EN2 SUPER • AF-EN2_VTR ICE	07/06/00 00/00/00	
<b>F</b>	<b>995376</b>	FILTRO DISIDRATORE 15 GR 6X3 DEHYDRATOR FILTER 15 GR 6X3	AR-EN1 • ARP-EN1 • AL-EN1	01/01/95 00/00/00	
<b>F</b>	<b>995377</b>	FILTRO DISIDRATORE 25 GR 6X3 DEHYDRATOR FILTER 25 GR 6X3	AF-EN1 • AR-EN2 • ARP-EN2 • AL-EN2 • AG60 SILVER H2O • AS	01/01/95 00/00/00	
<b>F</b>	<b>995482</b>	FILTRO DISIDRATORE 40 GR 6X3 DEHYDRATOR FILTER 40 GR 6X3	AG60	01/01/95 00/00/00	
<b>F</b>	<b>995690</b>	FILTRO DISIDRATORE ODF DML032S 023Z455 DEHYDRATOR FILTER ODF DML032S 023Z455	AL SUPER • AF-EN2 SUPER	01/01/95 00/00/00	
<b>FA</b>	<b>935997</b>	FILTRO X GOMMA ALIMENT.IDR.3/4' FILTER FOR HOSEPIPE 3/4'	AL • AS	24/05/02 00/00/00	
<b>FRE</b>	<b>935695</b>	FRONTALINO ESTERNO AR IRIIDIUM EXTERNAL FRONTAL PANEL IRIIDIUM CABINET	EN GOLD • ARP • AG60 GOLD • AS	11/04/03 00/00/00	
<b>FRI</b>	<b>935694</b>	FRONTALINO INTERNO AR IRIIDIUM INSIDE FRONTAL PANEL IRIIDIUM CABINET	EN GOLD • ARP • AG60 GOLD • AS	11/04/03 00/00/00	
<b>G</b>	<b>996200</b>	TELETERMOSTATO ID974 EN TN/BT TELETERMOSTAT ID974 EN TN/BT	EN SILVER • AG60 SILVER	29/05/03 00/00/00	●
<b>G</b>	<b>996033</b>	TELETERMOSTATO EWPX 174 (BUZZER) AR TELETERMOSTAT EWPX 174 (BUZZER) CABINETS	AF-EN2_SUPER SILVER	01/01/95 28/05/03	●
	<b>996253</b>	TELETERMOSTATO ID974LX EN TELETERMOSTAT ID974LX EN		29/05/03 00/00/00	●
<b>G1</b>	<b>990228</b>	SCHEDA DI POTENZA FERMALIEV MICRO PIU POWER CARD CONTROLLED PROVING MICRO PIU	AL	28/07/99 10/11/10	●
	<b>997011</b>	SCHEDA DI POTENZA AR/TL FL EVC FL08 POWER CARD AR/TL FL EVC FL08		11/11/10 00/00/00	●
<b>G1</b>	<b>996211</b>	SCHEDA DI POTENZA SERIE IRIIDIUM 08/2002 POWER CARD IRIIDIUM 08/2002	EN GOLD • AF-EN_VTR ICE • ARP • AG60 GOLD	01/01/95 05/06/08	●
	<b>996714</b>	SCHEDA DI POTENZA EVCO IRIIDIUM POWER CARD IRIIDIUM EVCO		06/06/08 00/00/00	●
<b>G1+G2</b>	<b>996309</b>	SCHEDA COMANDO+POTENZA AR IRIIDIUM COMMAND + POWER CARD IRIIDIUM	EN GOLD • AF-EN_VTR ICE • ARP • AG60 GOLD	01/01/95 05/06/08	●
	<b>996614</b>	ASS.SCHEDA ELET.EVCO IRIIDIUM COMMAND + POWER CARD IRIIDIUM EVCO		06/06/08 00/00/00	●
<b>G1+G2</b>	<b>996792</b>	SCHEDA ELET.EVCO IRIIDIUM STAGIONATORE ELECTRIC CARD EVCO IRIIDIUM SEASONER	AS	04/02/09 00/00/00	●
<b>G1+G2</b>	<b>997016</b>	ASS.SCHEDA AR/TL FERMALIEV. FL EVC FL08 PROVING ELECTRIC CARD AR/TL FL EVC FL08	AL	11/11/10 00/00/00	●
<b>G2</b>	<b>990227</b>	SCHEDA DI COMANDO FERMALIEV MICRO PIU COMMAND CONTROLLED PROV. CARD MICRO PIU	AL	01/01/95 10/11/10	●
	<b>997013</b>	SCHEDA TASTIERA AR/TL FL EVC FL08 COMMAND CARD AR/TL FL EVC FL08		11/11/10 00/00/00	●
<b>G2</b>	<b>996212</b>	SCHEDA DI COMANDO SERIE IRIIDIUM 08/2002 COMMAND CARD IRIIDIUM 08/2002	EN GOLD • AF-EN2_VTR ICE • ARP • AG60 GOLD	01/01/95 05/06/08	●
	<b>996715</b>	SCHEDA DI COMANDO EVCO IRIIDIUM COMMAND CARD EVCO IRIIDIUM		06/06/08 00/00/00	●
<b>G3</b>	<b>990229</b>	SCHEDA AUSILIARIA FERMALIEV MICRO PIU AUX. CONTROLLED PROVING CARD MICRO PIU	AL	28/07/99 11/11/10	●
	<b>997012</b>	SCHEDA DI ESPANSIONE AR/TL FL EVC FL08 EXPANSION CARD AR/TL FL EVC FL08		11/11/10 00/00/00	●
<b>GA</b>	<b>935679</b>	GOMMA ALIMENTAZ. IDR. 3/4 GAS L=2500 HOSEPIPE 3/4 GAS L=2500	AL	21/02/02 00/00/00	
<b>GC x1</b>	<b>990586</b>	GUIDA SINGOLA 'C' PER EN2 ICE 'C' SLIDE FOR EN2 ICE	AF-EN2 ICE • AS	04/05/05 00/00/00	
<b>GC x2</b>	<b>990443</b>	COPPIA GUIDE A 'C' PER EN2 ICE PAIR OF 'C' SLIDES FOR EN2 ICE	AF-EN2 ICE • AS	04/05/05 00/00/00	
<b>GC x2</b>	<b>996696</b>	COPPIA GUIDE 'C' DA 620 PER AR EN GELA PAIR OF 'C' SLIDES 620 FOR EN ICE CABINETS	AG60	18/06/08 00/00/00	

referim. reference	codice code	descrizione description	modello model	da...a from...to	ricambi cons. rec. spare part
<b>GL x1</b>	<b>935669</b>	GUIDA A 'L' DA 730 PER TEGLIE AR EN2 'L-SHAPED' SLIDE L=730 FOR BAKING TINS EN2	<b>EN2</b>	07/01/02 00/00/00	
<b>GL x1</b>	<b>935672</b>	GUIDA A 'L' DA 450 PER TEGLIE AR EN1 'L-SHAPED' SLIDE L=450 FOR BAKING TINS EN1	<b>EN1</b>	10/12/01 00/00/00	
<b>GL x2</b>	<b>990332</b>	COPPIA GUIDE A'L'PER EN1 PAIR OF 'L' SLIDES FOR EN1	<b>EN1</b>	10/12/01 00/00/00	
<b>GL x2</b>	<b>990333</b>	COPPIA GUIDE A'L'PER EN2 PAIR OF 'L' SLIDES FOR EN2	<b>EN2</b>	07/01/02 00/00/00	
<b>GPO</b>	<b>935638</b>	GUARNIZ. PORTA INTERA 670X1540 AR EN DOOR GASKET 670X1540 EN CABINETS	<b>EN • AG60 • AS</b>	01/01/95 16/05/07	●
	<b>936649</b>	NN22 GUARN.PORTA INTERA 640X1495 AR EN NN22 DOOR GASKET 640X1495 EN CABINETS		17/05/07 00/00/00	●
<b>GPO 1/2</b>	<b>935639</b>	GUARNIZ. PORTA MEZZA 670X740 AR EN1/EN2 HALF DOOR GASKET 670X740 EN1/EN2 CABINETS	<b>EN • AG60</b>	01/01/95 16/05/07	●
	<b>936672</b>	GUARN.PORTA 1/2 640X695 AR EN NEW HALF DOOR GASKET 640X695 EN1 NEW CABINETS		17/05/07 00/00/00	●
<b>GPO V</b>	<b>935954</b>	GUARNIZ.PORTA VETRO AR EN GLASS DOOR GASKET EN CABINETS	<b>EN</b>	12/07/06 31/12/08	●
	<b>997026</b>	GUARN. MM.648X1508 AR EN VTR 2008 GASKET MM.648X1508 FOR GLASS DOOR 2008		01/01/09 00/00/00	●
<b>GPV</b>	<b>925527</b>	GRIGLIA PROTEZIONE VENTILAT.4715FS FAN PROTECTION GRID 4715FS	<b>EN_H2O • AG60 H2O</b>	14/02/02 00/00/00	
<b>GPV</b>	<b>935194</b>	GRIGLIA PROTEZIONE VENTILATORE AR VINI FAN PROTECTION GRID WINES CABINETS	<b>AS</b>	05/02/09 00/00/00	
<b>GR</b>	<b>990026</b>	GRIGLIA EN 400X600 PLASTIFICATA PLASTICIZED SHELF EN 400X600	<b>AF-EN ICE</b>	07/10/03 00/00/00	
<b>GR</b>	<b>990027</b>	GRIGLIA GN2/1 INOX GN2/1 SHELF INOX	<b>AG60</b>	20/05/08 00/00/00	
<b>GR ICE</b>	<b>996695</b>	RIPIANO AR EN GELATO SHELF EN ICE CABINET	<b>AG60</b>	20/05/08 00/00/00	
<b>GS EN</b>	<b>935673</b>	MONT.X GUIDA A 'L' X TEGLIE AR EN1/EN2 UPRIGHTS FOR 'L' GUIDES BAKING TINS EN1/2	<b>EN • AG60</b>	10/12/01 00/00/00	
<b>GS ICE</b>	<b>936648</b>	ASS.MONTANTI VERS.GN PER ARMADI EN UPRIGHTS GN VERSION FOR EN CABINETS	<b>AG60 • AS</b>	20/05/08 00/00/00	
<b>H</b>	<b>995402</b>	LAMPADA SPIA GIALLA AR YELLOW INDICATOR LIGHT CABINETS	<b>AF-EN SILVER • AG60 SILVER</b>	13/10/03 00/00/00	
<b>I1</b>	<b>935074</b>	DEVIATORE BIPOLARE LUMINOSO VERDE FL B04 BIPOLAR SWITCH GREEN LIGHT B04	<b>AR-EN SILVER</b>	13/10/03 00/00/00	
<b>I1</b>	<b>935075</b>	INTER. UNIP. VERDE + DEV. UNIP. VERDE MAIN SWITCH GREEN + DEFL. UNIP. GREEN C/BL	<b>AR-EN_VTR SILVER</b>	13/10/03 00/00/00	
<b>I3</b>	<b>995405</b>	MICROPORTA MAGNETICO STEM E510 DOOR MICRO-SWITCH STEM E510	<b>EN GOLD • ARP • AG60 GOLD</b>	01/01/95 00/00/00	●
<b>I3</b>	<b>996356</b>	MICROINTERRUTTORE PORTA AR MICRO-SWITCH DOOR CABINETS	<b>EN1 SILVER • AG60 SILVER</b>	01/01/95 31/12/07	●
	<b>936091</b>	BN MICROINT. MECCANICO 3 TERMINALI BN MECHANICAL MICRO-SWITCH 3 TERMINALS		01/01/08 00/00/00	●
<b>I3</b>	<b>995047</b>	MAGNETE X MICROPORTA MND IAM 018 005T MAGNET FOR MICRO-S. DOOR MND IAM 018 005T	<b>EN_VTR • ARP_VTR • AG60 GOLD • AS</b>	12/06/08 00/00/00	
<b>IG</b>	<b>995410</b>	INTERRUTT.VERDE+SPIA GIALLA AR P.V. GREEN SWITCH + YELLOW LIGHT DOOR GLAS. C.	<b>AF-EN1_VTR SILVER • AF-EN2 SILVER</b>	13/10/03 00/00/00	
<b>IG</b>	<b>995647</b>	*****INTERRUTTORE BIP.LUM BLU 0401/2/C MAIN SWITCH BLUE LIGHT	<b>EN SILVER</b>	01/01/95 27/05/03	
	<b>995257</b>	INTERRUTTORE GENERALE VERDE C/GRIGIA MAIN SWITCH GREEN C/GRAY		28/05/03 00/00/00	
<b>IG</b>	<b>995257</b>	INTERRUTTORE GENERALE VERDE C/GRIGIA MAIN SWITCH GREEN C/GRAY	<b>AG60 SILVER</b>	28/05/03 00/00/00	
<b>IG</b>	<b>996032</b>	INTERRUTTORE BIPOLARE LUMINOSO BIANCO BIPOLAR SWITCH LIGHT WHITE	<b>AL_VTR</b>	28/06/07 00/00/00	
<b>kit CE/M3</b>	<b>930295</b>	KIT CONV/RES/VENT AR EN NEW CONVEYOR/RESIST./FAN KIT EN AR NEW	<b>AR-EN • ARP • AL</b>	11/11/05 00/00/00	
<b>kit CE/M3</b>	<b>930296</b>	KIT CONV/RES/VENT AF EN NEW CONVEYOR/RESIST./FAN KIT EN AF NEW	<b>AF-EN • AL-EN2 SUPER</b>	11/11/05 00/00/00	
<b>kit CO H2O</b>	<b>996655</b>	KIT CONDENS.ACQUA SALDOBRAZ B5/ZC207 WATER CONDENSER KIT BRAZED B5/ZC207	<b>EN_H2O • AG60 H2O</b>	20/11/05 00/00/00	
<b>kit CO+M2</b>	<b>990396</b>	KIT CONDENSAZIONE ACQUA B5 + VENTILATO WATER CONDENSER KIT B5 + FAN	<b>EN_H2O</b>	20/11/05 00/00/00	
<b>kit I3</b>	<b>995264</b>	MICROINTERRUTTORE+PIASTRINA PORTA AR MICRO-SWITCH + DOOR CABINETS PLATE	<b>EN SILVER</b>	01/01/95 31/12/07	●

referim. reference	codice code	descrizione description	modello model	da...a from...to	ricambi cons. rec. spare part
kit M2	995525	MOTORE+VENTOLA COND. STVF 93-139 ENGINE + CONDENSER FAN STVF 93-139	> 995522 > 995524	19/11/05 00/00/00	●
kit M2	995526	MOTORE+VENTOLA COND. STVF 124/194 ENGINE + CONDENSER FAN STVF 124/194	> 995523	08/04/03 00/00/00	●
kit M2	996161	MOTORE+VENTOLA COND. STVF 273 ENGINE + CONDENSER FAN STVF 273	> 995908	08/04/03 00/00/00	●
LL	995757	LIVELLOSTATO 'MOD.P500' LIEVITAMATIC LEVEL CONTROL 'MOD.P500' LIEVITAMATIC	AL • AS	21/02/02 00/00/00	
M1	995711	COMPRESSORE 34,37CC J2212GK CSR R404A COMPRESSOR 34,37CC J2212GK CSR R404A	AF-EN2 SUPER • AF-EN2 ICE_VTR	01/03/98 00/00/00	
M1	995746	COMPRESS. 20,4 CC T2178GK/SC18CL R404A COMPRESSOR 20,4 CC T2178GK/SC18CL R404A	AF-EN1_VTR • AF-EN1 ICE	15/09/08 00/00/00	
M1	995770	COMPRESS. 22,4 CC.T2180GK-SC21CL R404A COMPRESSOR 22,4 CC.T2180GK-SC21CL R404A	AF-EN2 • AF-EN2 ICE • AL-EN2 SUPER • AG60	30/04/97 00/00/00	
M1	995983	COMPRESSORE DANFOSS SC 15 G R134A COMPRESSOR DANFOSS SC 15 G R134A	AL-EN2 • AS	03/11/05 00/00/00	
M1	995740	COMPRESSORE NL7.3MF FR8.5G/B6160Z R134 COMPRESSOR NL7.3MF FR8.5G/B6160Z R134	AR-EN1 • ARP-EN1	01/03/98 05/11/06	
	996353	COMPRESS.DANFOSS NL7.3MF R134A 230/50-60 COMPRESSOR DANF. NL7.3MF R134A 230/50-60		06/11/06 00/00/00	
M1	995742	COMPRESSORE 8,85 CC B6170Z/FR10G R13 COMPRESSOR 8,85 CC B6170Z/FR10G R13	AL-EN1	01/03/98 00/00/00	
M1	995743	COMPRESSORE 12,00 CC E6187Z/SC12G R134 COMPRESSOR 12,00 CC E6187Z/SC12G	AR-EN2 • ARP-EN2	01/03/98 12/03/06	
	996355	COMPRESS.DANFOSS NL10 MF R134A 230/50-60 COMPRESSOR DANF. NL10 MF R134A 230/50-60		13/03/06 00/00/00	
M1	996725	COMPRESSORE DANFOSS SC 15 CLX.2 R404A COMPRESSOR DANFOSS SC 15 CLX.2 R404A	AF-EN1 • AL-EN1 SUPER	15/09/08 10/05/11	
	995745	COMP. 17,4 CC NEK2168GK/SC15CL R404 COMPR. 17,4 CC NEK2168GK/SC15CL R404		11/05/11 00/00/00	
M2	995635	VENTIL. PIATTO D=120 230V 4715MS-23T-B FLAT FAN D=120 230V 4715MS-23T-B	EN_H2O	14/02/02 00/00/00	●
M3	935581	VENTIL.TANGENZ.AR SILV/EN L.CAVO 1800 TANGENT FAN AR SILV/EN 1800 LONG LINE	AG60 ARIA/ACQUA AG60 AIR/WATER	14/11/04 00/00/00	●
M3	935581	VENTIL.TANGENZ.AR SILV/EN L.CAVO 1800 TANGENT FAN AR SILV/EN 1800 LONG LINE	EN • ARP • AL • AG60 • AS	14/11/04 03/11/08	●
	995635	VENTIL. PIATTO D=120 230V 4715MS-23T-B FLAT FAN D=120 230V 4715MS-23T-B		04/11/08 00/00/00	●
M3	935630	VENTIL. MA-VIB EVF10A 200-27° AP + VIT FAN MA-VIB EVF10A 200-27° AP	AF-EN2 SUPER	18/06/01 00/00/00	●
M4	915008	VENTILAT FANDIS A08A23SWBY00 80X80 FLAT FAN FANDIS A08A23SWBY00 80X80	AS	05/02/09 00/00/00	●
kit M3	935647	VENTIL. MA-VIB EVF10A 200-27° AP + VIT FAN MA-VIB EVF10A 200-27° AP	AF-EN2 SUPER	23/05/01 00/00/00	●
MAS	935884	MASCHERINA COMANDI IRIIDIUM GRIGIA FRX CONTROL PANEL IRIIDIUM GRAY FRX	AS	28/04/04 00/00/00	
MAS	935890	MASCHERINA COMANDI IRIIDIUM GIALLA FRX CONTROL PANEL IRIIDIUM YELLOW FRX	EN GOLD • ARP • AG60 GOLD	28/04/04 00/00/00	
MAS	995977	MASCHERINA COMANDI FERMALIEVITA MICRO+ CONTROL PANEL FOR CONTR. PROVING MICRO	AL	01/01/95 10/11/10	
	997014	MASCHERINA AR/TL FL EVC FL08 FRX CONTROL PANEL FOR AR/TL FL EVC FL08 FRX		11/11/10 00/00/00	
MAS T	935652	MASC.PASTICC. AR EN1-2 RESINATA BAKING CONTROL PANEL EN1-2 CAB. RESINED	AR-EN SILVER	26/01/05 00/00/00	
MAS T	935076	MASCH. COMANDI AR EN1-EN2 BT RESINATA CONTROL PANEL EN1-EN2 CABINET RESINED	AF-EN SILVER • AG60 SILVER	26/01/05 00/00/00	
MN	935955	MANIGLIA PORTA VTR AR STAR NEW HANDLE FOR GLASS DOOR STAR CABINETS NEW	EN_VTR	01/09/08 00/00/00	
MN	935195	MANIGLIA PORTA VETRO SUT / EN 2009 HANDLE FOR GLASS DOOR SUT / EN 2009	AS_VTR	04/02/09 00/00/00	
MT	995496	MANOPOLA X TIMER-COMMUTATORE TIMER-COMMUTATOR CONTROL	AF-EN SILVER • AG60 SILVER	27/02/02 00/00/00	●
O	995393	PROGRAMMATORE DI CICLI 230V CYCLES PROGRAMMER 230V	AF-EN • AG60 SILVER	16/12/99 00/00/00	
OR	995714	ORIFIZIO N°0,5-FLICA N°0,5 ORIFICE - FLICA	AR-EN-P • AL-EN SUPER	29/11/00 04/04/04	
	996208	ORIFIZIO N°00 DANFOSS N°00 ORIFICE DANFOSS		05/04/04 00/00/00	

referim. reference	codice code	descrizione description	modello model	da...a from...to	ricambi cons. rec. spare part
OR	995717	ORIFIZIO N°1,5--FLICA N°1,5 ORIFICE - FLICA	AF-EN-P • AF-EN2 SUPER • AL-EN1 -P • AL-EN2 SUPER • AG60 -P	15/02/01 04/04/04	
	996263	ORIFIZIO N°01 ODF DANFOSS N°01 ORIFICE ODF DANFOSS		05/04/04 00/00/00	
P	995240	PRESSOSTATO KP 5 AUTOMATICO HP KP 5 PRESSURE SWITCH AUTOMATIC HP	EN2_H2O • AG60 H2O	17/11/05 00/00/00	●
P/I3	935898	PIASTRINA ISOLANTE MICRO PORTA INSULATING PLATE FOR MICRO-SWITCH	EN SILVER	01/01/95 31/12/07	
PC G	965648	PARACOLPO D=20,5 H=7,6 BUMPER D=20,5 H=7,6	EN • AG60 • AS	01/01/95 00/00/00	
PI 1	990581	ASS.PIEDINO 2" FOOT ASSEMBLY 2'	EN • AG60 • AS	02/04/04 18/09/07	
	930269	ASSIEME PIEDINO TR NEW 2' H=145-205 FOOT ASSEMBLY TR NEW 2' H=145-205		19/09/07 00/00/00	
PI 2	995012	PIEDE INOX LISCIO DA 2"G AR MNSC INOX FOOT 2' G MNCQ CABINETS	EN • AG60 • AS	02/04/04 18/09/07	
	995024	PIEDINO INOX 2' GAS L= 92 AR TR INOX FOOT 2' GAS L=92 TR CABINETS		19/09/07 00/00/00	
PI 4	995011	SUPPORTO PIEDE INOX AR MNSC AGF0082 INOX FOOT SUPPORT MNCQ CABINETS AGF0082	EN • AG60 • AS	02/04/04 18/09/07	
	995025	ASS.SUP.PIEDE PIASTRA L=130 AR EN+TR N INOX FOOT SUPPORT L=130 EN+TR CAB. NEW		19/09/07 00/00/00	
PL	935633	PANNELLO LAT DX AR EN1 RIGHT SIDE PANEL EN1 CABINETS	EN1	11/07/01 12/11/08	
	935077	PANNELLO LATERALE DX AR EN1 NEW RIGHT SIDE PANEL EN1 CABINETS NEW		13/11/08 00/00/00	
PL	935634	PANNELLO LAT.SX AR EN1 LEFT SIDE PANEL EN1 CABINETS	EN1	11/07/01 12/11/08	
	935078	PANNELLO LATERALE SX AR EN1 NEW LEFT SIDE PANEL EN1 CABINETS NEW		13/11/08 00/00/00	
PL	935635	PANNELLO LAT DX AR EN2 RIGHT SIDE PANEL EN2 CABINETS	EN2 • AS	11/07/01 13/11/08	
	935079	PANNELLO LATERALE DX AR EN2 NEW RIGHT SIDE PANEL EN2 CABINETS NEW		14/11/08 00/00/00	
PL	935636	PANNELLO LAT SX AR EN2 LEFT SIDE PANEL EN2 CABINETS	EN2 • AS	11/07/01 13/11/08	
	935085	PANNELLO LATERALE SX AR EN2 NEW LEFT SIDE PANEL EN2 CABINETS NEW		14/11/08 00/00/00	
PL	936645	PANNELLO LAT.SX AR EN GELATO LEFT SIDE PANEL EN ICE CABINET	AG60	20/05/08 00/00/00	
PL	936646	PANNELLO LAT.DX AR EN GELATO RIGHT SIDE PANEL EN ICE CABINET	AG60	20/05/08 00/00/00	
PO	935641	ASS.PORTA INTERA AR EN1/EN2 DOOR FOR EN1/2 CABINETS	EN SILVER	01/01/95 12/11/08	
	935086	ASSIEME PORTA INTERA AR EN-EN2 NEW DOOR FOR EN1/2 CABINETS NEW		13/11/08 00/00/00	
PO	935911	ASS.PORTA INTERA AR EN1/EN2 GOLD DOOR FOR EN1/EN2 CABINETS GOLD	EN GOLD • AG60 GOLD • AL-EN2 • AS	01/01/95 12/11/08	
	936651	ASS.PORTA INTERA AR EN GOLD NEW DOOR FOR EN CABINETS GOLD NEW		13/11/08 00/00/00	
PO	935641	ASS.PORTA INTERA AR EN1/EN2 DOOR FOR EN1/2 CABINETS	AL-EN1	01/01/95 17/12/07	
	935911	ASS.PORTA INTERA AR EN1/EN2 GOLD DOOR FOR EN1/EN2 CABINETS GOLD		18/12/07 00/00/00	
PO	936650	ASS.PORTA INTERA AR EN PANNELLATA DOOR EN CABINET paneled	AG60 SILVER	20/05/08 00/00/00	
PO 1/2	935642	ASS PORTA MEZZA AR EN1/EN2 HALF DOOR EN1/EN2 CABINETS	EN SILVER	01/01/95 12/11/08	
	935087	ASSIEME PORTA MEZZA AR EN1-EN2 NEW HALF DOOR EN1/EN2 NEW CABINETS		13/11/08 00/00/00	
PO 1/2	935915	ASS.PORTA 1/2 AR EN1/EN2 GOLD HALF DOOR EN1/2 CABINETS GOLD	EN1 GOLD	08/11/04 12/11/08	
	935088	ASSIEME PORTA MEZZA AR EN GOLD NEW HALF DOOR EN1/2 CABINETS GOLD NEW		13/11/08 00/00/00	
PO 1/2	935916	ASS.PORTA 1/2 INF.DX AR EN1/EN2 GOLD LOWER RIGHT HALF DOOR EN1/EN2 CAB. GOLD	EN GOLD	08/11/04 12/11/08	
	935089	ASS. PORTA MEZZA INF. DX AR EN GOLD NEW LOWER RIGHT HALF DOOR EN CAB. GOLD NEW		13/11/08 00/00/00	

referim. reference	codice code	descrizione description	modello model	da...a from...to	ricambi cons. rec. spare part
PO 1/2	6234360	ASS.PORTA MEZZA SCH.INF.SX AR EN GOLD LOWER LEFT HALF DOOR EN CABINETS GOLD	EN GOLD	08/11/04 12/11/08	
	935094	ASS. PORTA MEZZA INF. SX AR EN GOLD NEW LOWER LEFT HALF DOOR EN CAB. GOLD NEW		13/11/08 00/00/00	
PO 1/2	935120	ASS. PORTA 1/2 SUP. DX/SX AR EN PANN. RIGHT/LEFT UPPER HALF DOOR EN CABINETS	AG60 SILVER	23/02/09 00/00/00	
PO V	935900	PORTA VTR DX TN 2VTR B.E. AR EN NEW RIGHT GLASS DOOR TN 2 GLASSES EN CAB. NEW	AR-EN_VTR • ARP	01/01/95 17/11/08	
	935095	PORTA VTR DX TN 2VTR B.E. AR EN NEW RIGHT GLASS DOOR TN 2 GLASSES EN CAB. NEW		18/11/08 00/00/00	
PO V	935901	PORTA VTR SX TN 2VTR B.E. AR EN NEW LEFT GLASS DOOR TN 2 GLASSES EN CAB. NEW	AR-EN_VTR • ARP	01/01/95 17/11/08	
	935096	PORTA VTR SX TN 2VTR B.E. AR EN NEW LEFT GLASS DOOR TN 2 GLASSES EN CAB.		18/11/08 00/00/00	
PO V	935902	PORTA VTR 3VTR RISC.DX+LUCE+VAR.TEN.NEW RIGHT GLASS DOOR 3 GLASS. WARMED + LIGHT	AF-EN_VTR • AL	01/01/95 17/11/08	
	935098	PORTA VTR 3VTR RISC. DX + LUCE EN NEW RIGHT GLASS DOOR 3 GL.WARMED+LIGHT EN NEW		18/11/08 00/00/00	
PO V	935903	PORTA VTR 3VTR RISC.SX+LUCE+VAR.TEN.NEW LEFT GLASS DOOR 3 GLASSES WARMED + LIGHT	AF-EN1_VTR • AL	01/01/95 17/11/08	
	935097	PORTA VTR 3VTR RISC. SX + LUCE EN NEW LEFT GLASS DOOR 3 GL. WARMED+LIGHT EN NEW		18/11/08 00/00/00	
PO V	935196	PORTA VETRO 2VTR DX LED AR EN 2009 RIGHT GLASS DOOR 2 GLASSES LED EN 2009 CAB.	AS_VTR	04/02/09 00/00/00	
PR 3	996600	RUOTA GIR D=100 3477PJO100/30P62 C/F REVOLVING CASTOR D=100 WITH BRAKES	EN • AG60 • AL • AS	__ 00/00/00	
PR 4	996599	RUOTA GIR D=100 3470PJO100/30P62 S/F REVOLVING CASTOR D=100 WITHOUT BRAKES	EN • AG60 • AL • AS	__ 00/00/00	
PVE	995776	ASS.SEMIPROT.VALVOLA 'FLICA-DANFOSS' SEMI-PROTECTION VALVE 'FLICA/DANFOSS'	-P • AF-EN2 SUPER • AL-EN SUPER	29/11/00 00/00/00	
Q	995712	RELE'AVV.3ARR3B3AV3 RVA112 (J2212GK START. RELAY 3ARR3B3AV3 RVA112 (J2212GK	> 995711	30/01/01 00/00/00	●
Q	996017	RELE' AVVIAMENTO DANFOSS '117U6003' STARTING RELAY DANFOSS '117U6003'	> 995743	01/03/98 00/00/00	●
Q	996018	RELE' AVVIAMENTO DANFOSS '117U6005' STARTING RELAY DANFOSS '117U6005'	> 995983	15/11/01 00/00/00	●
Q	996019	RELE' AVVIAMENTO DANFOSS '117U6010' STARTING RELAY DANFOSS '117U6010'	> 995742	15/11/01 00/00/00	●
Q	996021	RELE' AVVIAMENTO DANFOSS '117U6019' STARTING RELAY DANFOSS '117U6019'	> 996725 > 995747	11/06/08 00/00/00	●
Q	996548	RELE' AVVIAMENTO DANFOSS '117U6016' STARTING RELAY DANFOSS '117U6016'	> 996353 > 996354	01/06/07 00/00/00	●
Q	996549	RELE' AVVIAMENTO DANFOSS '117U6022' STARTING RELAY DANFOSS '117U6022'	> 996355	01/06/07 00/00/00	●
Q	996751	RELE' AVVIAMENTO DANFOSS '117U6013' STARTING RELAY DANFOSS '117U6013'	> 995746	11/06/08 00/00/00	●
Q1	995345	RELE'DI POTENZA 30A 250V POWER RELAY 30A 250V	AL	25/06/98 00/00/00	●
R1	935353	RESISTENZA PORTA INTERA AF MNSC 52W FRAME HEATER DOOR AF MNSC 52W	EN • AG60 SILVER • AL • AS	15/11/04 31/12/07	●
	935849	RES.BATT.GUARN.PORTA 31W PLANET/STAR FRAME HEATER DOOR 31W PLANET/STAR		01/01/08 00/00/00	●
R1	935190	RESISTENZA CORNICE PORTA L=4230 15W/M EN FRAME HEATER DOOR L=4230 15W/M EN	AG60 GOLD	01/01/08 00/00/00	●
R1	935354	RESISTENZA PORTE MEZZE AF MNSC 68W FRAME HEATER HALF DOORS AF MNSC 68W	AR-EN	01/01/95 00/00/00	●
R1	935354	RESISTENZA PORTE MEZZE AF MNSC 68W FRAME HEATER HALF DOORS AF MNSC 68W	AF-EN • AG60 SILVER	01/01/95 31/12/07	●
	935850	RES.BAT.GUARN.P.1/2 41W PLANET/STAR HALF DOORS FRAME HEATER 41W PLANET/STAR		01/01/08 00/00/00	●
R2	935614	RES.SBRIN.EVAP.3RANGHI AR SILVER/EN DEFR. RESIST. EV. 3 ROWS SILVER/EN CAB.	AF-EN2 • AF-EN1_VTR • AF-EN1_ICE • AR-EN2 • ARP-EN2 • AL-EN2 • AG60 • AS	01/07/05 00/00/00	●
R2	990337	RES.SBRIN.EVAP.2R AR-SILVER+CONT.MASCH DEFR. RESISTANCE EVAP. 2 ROWS SILVER CAB.	AR-EN1 • AF-EN1 • AR-EN1_VTR • ARP- EN1 • AL-EN1	14/11/04 00/00/00	●
R3	935616	RES. EVAPORAZ. 100W 230V EVAP. CONDENCE RESIST. 100W 230V	-P • AL • AS	12/01/01 00/00/00	●
R3	995941	RESISTENZA 190W UMIDIFIC. TR LIEVITAM. RESISTANCE HUMIDIF. 190 RC LIEVITAMATIC	AL • AS	21/02/02 00/00/00	●

referim. reference	codice code	descrizione description	modello model	da...a from...to	ricambi cons. rec. spare part
<b>R4</b>	<b>936682</b>	RESISTENZA H25 3C VT27 230V 500+500W RESISTANCE H25 3C VT27 230V 500+500W	<b>AL • AS</b>	07/03/02 00/00/00	●
<b>R4</b>	<b>945005</b>	RESISTENZA SCARICO CONDENSA CELLE 100W DISCHARGE COND. RESITANCE C. ROOMS 100W	<b>ARP • AL</b>	10/05/04 31/12/08	●
	<b>996788</b>	RESISTENZA PRALINERIA 150W CORAZZATA PRALINE RESISTANCE 150W		01/01/09 30/11/10	●
	<b>935677</b>	ASS.RESISTENZA+STAFFE EN2 LIEVITAMATIC HEATER ASS.+ FRAME FOR EN2 LIEVITAMATIC		01/12/10 00/00/00	●
<b>R6</b>	<b>935876</b>	RES.FLESS. DI SCARICO AR STAR 21W 230V DISCHARGE FLEX. RESIST. AR STAR 21W 230V	<b>AF-EN1 • AF-EN2 • AG60</b>	16/11/04 00/00/00	●
<b>RL</b>	<b>995906</b>	RICEVITORE DI LIQUIDO 0,58 LITRI LIQUID RICEIVER 0,58 LITERS	<b>AF-EN2 SUPER • AL SUPER</b>	07/10/06 00/00/00	
<b>RP</b>	<b>945724</b>	REGOLATORE PRESSIONE CRO-4-0/75 R404A PRESSION REGULATOR CRO-4-0/75 R404A	<b>AG60 G/CALDO</b>	16/11/04 00/00/00	
<b>S</b>	<b>995851</b>	STARTER PER TUBI AL NEON STARTER DEVICE FOR TUBULAR LAMP	<b>EN_VTR</b>	14/09/98 00/00/00	
<b>S/MS</b>	<b>996745</b>	SUPPORTO MAGNETE E SERRATURA MAGNET AND LOCKING SUPPORT	<b>EN • AG60 • AS</b>	21/11/08 00/00/00	
<b>S/R4</b>	<b>935101</b>	SUPP. RESISTENZE EN2 VENTOLE ASSIALI RESISTANCE SUPPORT EN2 AXIAL FAN	<b>EN • AG60 • AS</b>	04/11/08 00/00/00	
<b>SCE</b>	<b>936027</b>	ASS.SCATOLA ELETTR.AF STAR-EN-PLANET ELECTRIC BOX AF STAR-EN-PLANET	<b>AF EN GOLD</b>	08/11/04 05/06/08	
	<b>936047</b>	ASS.SCATOLA ELETTR.AR7-14 STAR-EN-PLANET ELECTRIC BOX ASS. AR7-14 STAR-EN-PLANET		06/06/08 00/00/00	
<b>SCE</b>	<b>936047</b>	ASS.SCATOLA ELETTR.AR7-14 STAR-EN-PLANET ELECTRIC BOX ASS. AR7-14 STAR-EN-PLANET	<b>AR EN GOLD • ARP • AG60 GOLD</b>	08/11/04 00/00/00	
<b>SCE</b>	<b>990580</b>	ASS.SCATOLA EL. AR EN ID974 ELECTRIC BOX ASS. EN CABINETS ID974	<b>AR-EN SILVER</b>	03/07/06 00/00/00	
<b>SCE</b>	<b>935102</b>	SCATOLA ELETT. AR FERMALIEVITA + TRIVAL. ELECTRIC BOX ASS. CONTROLLED PROVING CAB.	<b>AL</b>	15/06/98 10/11/10	
	<b>6839750</b>	ASS.SCATOLA ELETT. AL EN FERMALIEV.FL08 ELECTRIC BOX ASS. AL EN FERMALIEV.FL08		11/11/10 00/00/00	
<b>SCE</b>	<b>935109</b>	ASS.SCAT.EL.ARMADI AF EN1/EN2 ID974 ELECTRIC BOX ASS. AF EN1/EN2 CAB. ID974	<b>AF-EN SILVER • AG60 SILVER</b>	13/11/06 00/00/00	
<b>SCE</b>	<b>935197</b>	ASS. SCAT.EL. AR7 STAR EVCO STAGIONATORE ELECTRIC BOX AR7 STAR EVCO SEASONER	<b>AS</b>	04/02/09 00/00/00	
<b>SCE/C</b>	<b>935103</b>	COPERCHIO SCATOLA FERMALIEVITA ARMADI COVER. ELECT. BOX CONTROLLED PROVING CAB.	<b>AL</b>	15/06/98 10/11/10	
<b>T</b>	<b>990319</b>	TRASFORMATORE 230/24V 17VA 50/60HZ TRANSFORMER 230/24V 17VA 50/60HZ	<b>AL</b>	12/07/02 00/00/00	●
<b>T</b>	<b>990435</b>	TRASFORMATORE 230/24V 17VA 50/60HZ TRANSFORMER 230/24V 17VA 50/60HZ	<b>EN GOLD</b>	08/11/04 05/06/08	●
<b>T2</b>	<b>915103</b>	REATTORE PER NEON 36W 220V 50HZ BALLAST - 36W 220V 50HZ	<b>EN_VTR • AS_VTR</b>	17/12/04 00/00/00	
<b>TAI</b>	<b>935191</b>	GOMMA ALIMENTAZ.IDR.3/4 GAS L=2500 WATER FEEDING HOSEPIPE 3/4 GAS L=2500	<b>AL • AS</b>	11/11/08 00/00/00	
<b>TEC</b>	<b>935104</b>	SERPENTINA EVAP. COND. AR SILVER - AR EN COIL PIPE EV. DEFROST WATER EN SILV. CAB.	<b>AR-EN • ARP • AL • AG60 H2O • AS</b>	14/11/04 00/00/00	
<b>TEC</b>	<b>935104</b>	SERPENTINA EVAP.COND. AR SILVER/AR EN COIL PIPE EV. DEFROST WATER EN SILVER CAB.	<b>AL-EN1 SUPER</b>	11/06/00 06/10/08	
	<b>935105</b>	SERPENTINA EVAPORA COND. AF-EN2 BT COIL PIPE EV. DEFROST WATER AF-EN2		07/10/08 00/00/00	
<b>TEC</b>	<b>935105</b>	SERPENTINA EVAPORA COND. AF-EN2 BT COIL PIPE EV. DEFROST WATER AF-EN2 R404A	<b>AF-EN1 • AF-EN2 • AF-EN2 ICE • AG60</b>	11/06/00 00/00/00	
<b>TEC</b>	<b>935106</b>	SERP. EV.COND. AR SILVER-AR EN COND. H2O COIL PIPE EV. DEFR.WATER EN WATER COND.	<b>EN1_H2O</b>	11/06/00 00/00/00	
<b>TEC</b>	<b>935107</b>	SERP. EVAPORA COND.EN2 SUPER-SILVER P.V. COIL PIPE EV. DEFROST WATER EN2 SUPER-SIL.	<b>AF-EN2 SUPER • AL-EN2 SUPER</b>	18/07/01 00/00/00	
<b>TG</b>	<b>996148</b>	TUBO FLEX GOMMA+CALZA 3/8M-1/2F L=200 FLEX PLAST. TUBE+BRAIDING 3/8M-1/2F L=200	<b>EN_H2O • AG60 H2O</b>	09/05/02 00/00/00	
<b>TR</b>	<b>935643</b>	ASS.TRAVERSA PORTA MEZZA AR EN1/EN2 CROSSBEAM HALF DOOR EN1/2 CABINET	<b>EN • AG60</b>	01/12/99 12/11/08	
	<b>935110</b>	ASS.TRAVERSA PORTA MEZZA AR EN1/EN2 NE CROSSBEAM HALF DOOR EN1/2 NEW CAB.		13/11/08 00/00/00	
<b>TS</b>	<b>935998</b>	NN12 SCAMBIATORE AF14 SILVER / AF-EN2 NN12 EXCHANGER AF14 SILVER / AF-EN2	<b>AF-EN1_VTR • AF-EN2 • AF-EN ICE • AG60</b>	07/06/00 00/00/00	
<b>TS</b>	<b>936058</b>	SCAMBIATORE AR EN1-EN2+IRIDIUM EXCHANGER EN1-EN2+IRIDIUM CABINET	<b>AR-EN • AL • ARP-EN1 • ARP-EN2 • AS</b>	07/06/00 00/00/00	

referim. reference	codice code	descrizione description	modello model	da...a from...to	ricambi cons. rec. spare part
<b>TS</b>	<b>996491</b>	NN12 SCAMBIATORE AF7 SILVER / AF-EN1 NN12 EXCHANGER AF7 SILVER / AF-EN1	<b>AF-EN1</b>	07/06/00 00/00/00	
<b>TS</b>	<b>935108</b>	ASS.SCAMBIATORE 1,24X1900 AF14VTR SILVER EXCHANGER 1,24X1900 AF14VTR SILVER	<b>AF-EN2_VTR ICE</b>	14/11/04 00/00/00	
<b>TSC</b>	<b>936661</b>	TUBO SCARICO BAC.EVAP.AR EN DRAIN EVAPORATOR COND. TUBE EN CABINETS	<b>EN • AG60 • AS</b>	07/06/00 00/00/00	
<b>V1</b>	<b>995682</b>	VALVOLA SOL.CASTEL ACQUA F-F 3/8"230V SOLENOID VALVE CASTEL WATER F-F 3/8"230V	<b>AL • AS</b>	16/03/04 00/00/00	●
<b>V1</b>	<b>995336</b>	VALVOLA SOLENOIDE 1/4"A SILDARE 230V SOLENOID VALVE 1/4"A TO SOLD 230V	<b>AG60 G/CALDO</b>	11/03/09 00/00/00	●
<b>VCC</b>	<b>936016</b>	VASCHET.EVAP.ACQUA CONDENSA AR EN1-2 TRAY EVAP. WATER CONDENSATE AR EN1-2	<b>EN • AG60</b>	31/07/00 00/00/00	
<b>VCC1</b>	<b>996419</b>	ASS.VASCHETTA UMID.LIEVITAMATIC EN EN LIEVITAMATIC TRAY TO COLLECT HUMIDITY	<b>AL • AS</b>	21/02/02 00/00/00	
<b>VE</b>	<b>995678</b>	VALV.TERMOSTAT.'TMV'+15/-30 R134A THERMOSTAT VALVE 'TMV'+15/-30 R134A	<b>AR-EN -P • AL-EN -P</b>	29/11/00 04/04/04	
	<b>996205</b>	VALV.TN2 68Z3384 ODF -40+10 S/MOP R13 VALVE TN2 68Z3384 ODF -40+10 S/MOP R13		05/04/04 00/00/00	
<b>VE</b>	<b>995771</b>	VALV.TERMOSTATICA'TMV'(MOP-18)R404 THERMOSTATIC VALVE 'TMV'(MOP-18 )R404	<b>AF-EN2 SUPER • AL-EN SUPER • AF- EN2 -P</b>	15/02/01 04/04/04	
	<b>996206</b>	VALVOLA TERMOSTATICA TS2 R404A SILDARE THERMOSTATIC VALVE TS2 R404A TO SOLD		05/04/04 00/00/00	
<b>VE</b>	<b>996206</b>	VALVOLA TERMOSTATICA TS2 R404A SILDARE THERMOSTATIC VALVE TS2 R404A TO SOLD	<b>AF-EN1 -P • AG60 SILVER -P</b>	05/04/04 00/00/00	
<b>VE</b>	<b>996257</b>	VALV.TS2 68Z3435 ODF -40+10 VALVE TS2 68Z3435 ODF -40+10	<b>AL-EN2 SUPER</b>	26/06/07 00/00/00	
<b>VEC</b>	<b>935951</b>	VASCHETTA RACC.COND.AR SILVER/AR EN CONDENSATE WATER TRAY EN/SILVER CABINETS	<b>AG60 ARIA/ACQUA</b>	07/06/00 00/00/00	
<b>VEC</b>	<b>935951</b>	VASCHETTA RACC.COND.AR SILVER/AR EN CONDENSATE WATER TRAY EN/SILVER CABINETS	<b>EN • ARP-EN2 • AL • AG60 • AS</b>	07/06/00 03/11/08	
	<b>935030</b>	VASCHETTA RACC.COND.AR EN MODIF.VE ASS CONDENSATE WATER TRAY EN CAB. MODIF.		04/11/08 00/00/00	
<b>VEC</b>	<b>936032</b>	VASCHETTA INOX EVAP.AR EN2 SUPER INOX TRAY EVAP. AR EN2 SUPER	<b>AF-EN2 SUPER</b>	08/05/01 00/00/00	
<b>VP</b>	<b>995492</b>	VALVOLA PRESSOSTATICA DA 3/8 ACQUA PRESSURE VALVE 3/8 WATER	<b>EN_H2O • AG60 H2O</b>	01/01/95 00/00/00	
<b>XB</b>	<b>965526</b>	MORSETTO PHOENIX MSTB 2,5/3-ST PAS=5 PHOENIX TERMINAL MSTB 2,5/3-ST PAS=5	<b>AR-EN1 GOLD • AG60 GOLD</b>	_/_/_ 00/00/00	
<b>W</b>	<b>995340</b>	LAMPADA NEON DA 36W L=1200 NEON LAMP 36W L=1200	<b>EN_VTR</b>	28/11/02 31/12/08	
<b>WL/S</b>	<b>997024</b>	KIT DX FERM.+LED PORTA AR EN RIGHT GLAZING BEAD+LED DOOR KIT EN CAB.	<b>EN_VTR</b>	01/01/09 00/00/00	
<b>WL/S</b>	<b>997025</b>	KIT SX FERM.+LED PORTA AR EN LEFT GLAZING BEAD+LED DOOR KIT EN CAB.	<b>EN1_VTR</b>	01/01/09 00/00/00	