

---

DESPIECE TECNICO

---

**Cocina de inducción  
Induction ranges  
Fourneaux induction  
Induktion-herde  
Cucine induzione  
Fogões indução**

**GAMA 900**

**Modelos:**

**CI9-20 PLUS**

**CI9-40 PLUS**

***Marzo 01/03/2011 March***

***Revisado Junio 2013 June Revised***



---

F A G O R I N D U S T R I A L

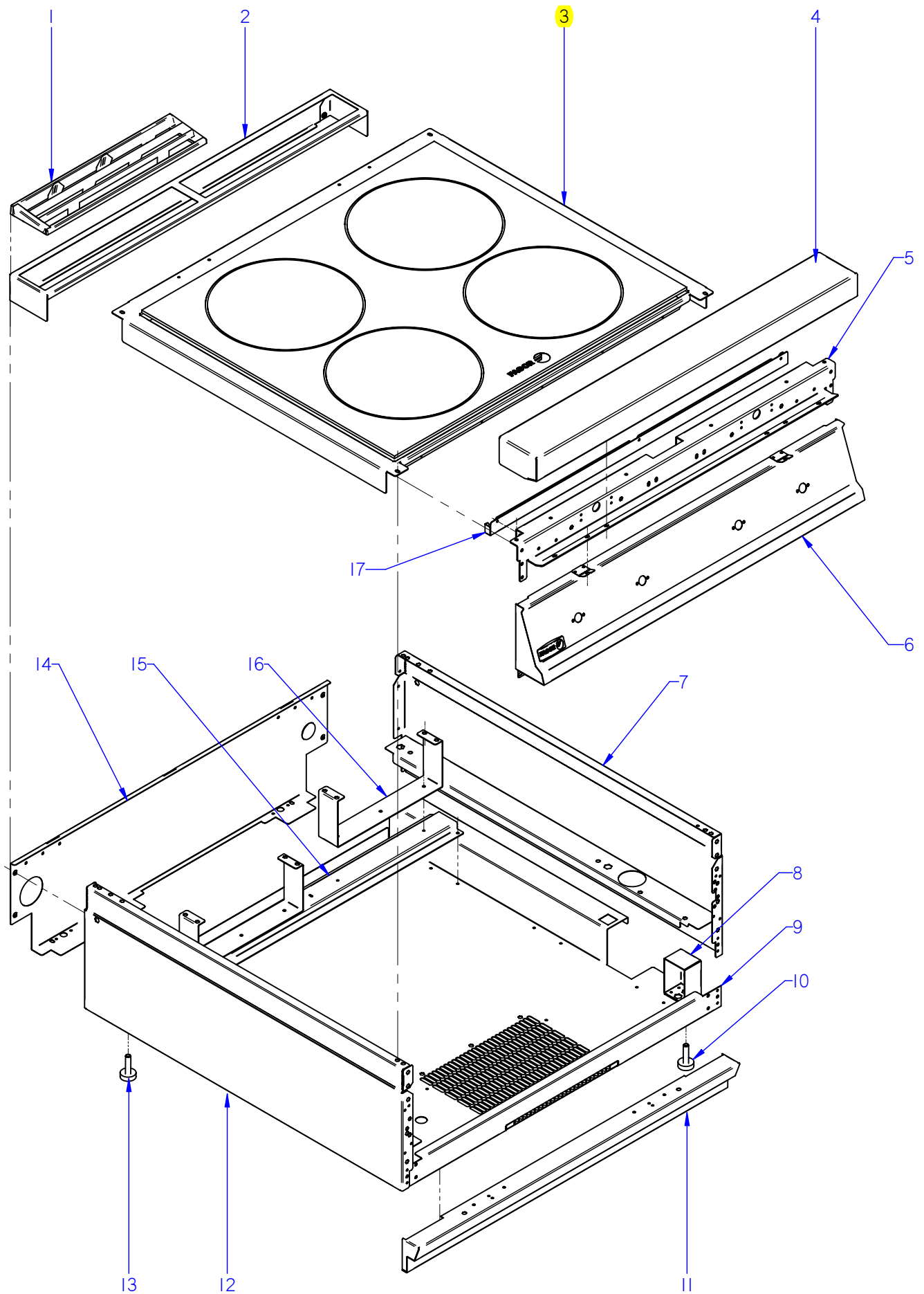

ITEM MARCADO EN COLOR = REPUESTO RECOMENDADO  
 COLOURED ITEM = RECOMMENDED SPARE PART

Nº plano / N° plane	Firma	Fecha / Date	Denominación / Denomination:	MUEBLE / FITTING	Lamina / Sheet	FAGOR
C-2693	<i>[Signature]</i>	2011-03	COCINA / RANGES CI9-20 / CI9-40 PLUS		1	FAGOR INDUSTRIAL

MOD.		COCINAS / RANGES		ZONA / ZONE		MUEBLE / FITTING							PLANO DIAGRAM		C-2693
ITEM	CODIGO REFERENCE	DENOMINACION	DENOMINATION	CI9-20 PLUS	CI9-40 PLUS							ELIMINADO ELIMINATED	INTRODUCID. INTRODUCED	NOTAS	
1	R205425000	EMBELLECEDOR ESMALTE	ENAMEL TRIM	1	2										
2	R205438000	SOPORTE EMBELLECEDOR 1/2M	1/2M TRIM SUPPORT	1											
2	R205439000	SOPORTE EMBELLECEDOR 1M	TRIM SUPPORT 1M		1										
	Q419005000	REMACHE 4X8 ALMG3 / ALUMINIO	RIVET 4X8 ALMG3 / ALUMINIUM	2	2										
3	U175410000	ENCIMERA COMPLETA CI9-20	TOP CI9-20 COMPL.	1											
3	U175409000	ENCIMERA COMPLETA CI9-40	TOP CI9-40 COMPL.		1							04.09.13			
3	12095134	ENCIMERA COMPLETA CI9-40	TOP CI9-40 COMPL.		1								04.09.13		
	Q012032000	TORNILLO EXAGONAL M5x15 A304	HEXAGONAL BOLT M5x15	6	6										
4	R045416000	ANTERIOR DE MESA 1/2 M	BENCH FRONT 1/2 M	1											
4	S105402000	ANTERIOR MESA 1 M	BENCH FRONT 1 M		1										
	Q152004000	TORNIL, APLASTADO M5x13 A304	FLAT HEADED BOLT M5x13 A304	2	2										
	Q302022000	ARANDELA 16x6x1,2 A304	WASHER 16x6x1,2 A304	2	2										
5	R042611000	ESCUADRA INTER. DE MESA 1/2M	INTER BRACKET. TABLE 1/2M	1											
5	U172618000	ESCUADRA INTER. DE MESA 1M	INTER BRACKET. TABLE 1 M		1										
	Q221342000	REMACHE EXAGONAL M5	HEXAGONAL RIVET M5	4	4										
	Q012032000	TORNILLO EXAGONAL M5x15 A304	HEXAGONAL BOLT M5x15	6	6										
	Q302022000	ARANDELA 16x6x1,2 A304	WASHER 16x6x1,2 A304	4	4										
	Q419005000	REMACHE 4x8 ALMG3 / ALUMINIO	RIVET 4X8 ALMG3 / ALUMINIUM	7	7										
	Q221345000	REMACHE EXAGONAL M10	HEXAGONAL RIVET M10	8	8										
6	U172815000	PORTAMANDOS CI9-20	CONTROL HOLDER CI9-20	1											
6	U172808000	PORTAMANDOS CI9-40	CONTROL HOLDER CI9-40		1										
	U022836000	ESCUDO FAGOR	FAGOR EMBLEM	1	1										
	Q221023000	CLIP SUJECIÓN RÁPIDA Ø5	RAPID CONNECT CLIP Ø5	2	2										
	Q152004000	TORNIL, APLASTADO M5x13 A304	FLAT HEADED BOLT M5x13 A304	2	2										
7	R062810000	PANEL LATERAL DERECHO	RIGHT SIDE PANEL	1	1										
	Q221343000	REMACHE EXAGONAL M6	HEXAGONAL RIVET M6	5	5										
	Q221342000	REMACHE EXAGONAL M5	HEXAGONAL RIVET M5	7	7										
8	U962627000	ESCUADRA AMARRE PATA AD	LEG FASTENING BRACKET AD	2	2										
	Q162030000	TUERCA EXAGONAL M5	HEXAGONAL NUT M5	4	4										
	Q302022000	ARANDELA 16x6x1,2 A304	WASHER 16x6x1,2 A304	4	4										
	X010503000	CIERRE MUELLE	LOCK SPRING	2	2										

MOD.		COCINAS / RANGES	ZONA / ZONE	MUEBLE / FITTING							PLANO DIAGRAM	C-2693	
ITEM	CODIGO REFERENCE	DENOMINACION	DENOMINATION	C19-20 PLUS	C19-40 PLUS						ELIMINADO ELIMINATED	INTRODUCID. INTRODUCED	NOTAS
1	R205425000	EMBELLECEDOR ESMALTE	ENAMEL TRIM	1	2								
2	R205438000	SOPORTE EMBELLECEDOR 1/2M	1/2M TRIM SUPPORT	1	-								
2	R205439000	SOPORTE EMBELLECEDOR 1M	TRIM SUPPORT 1M	-	1								
	Q419005000	REMACHE 4X8 ALMG3 / ALUMINIO	RIVET 4X8 ALMG3 / ALUMINIUM	2	2								
3	U175410000	ENCIMERA COMPLETA CI9-20	TOP CI9-20 COMPL.	1	-								
3	U175409000	ENCIMERA COMPLETA CI9-40	TOP CI9-40 COMPL.	-	1								
	Q012032000	TORNILLO EXAGONAL M5x15 A304	HEXAGONAL BOLT M5x15	6	6								
4	R045416000	ANTERIOR DE MESA 1/2 M	BENCH FRONT 1/2 M	1	-								
4	S105402000	ANTERIOR MESA 1 M	BENCH FRONT 1 M	-	1								
	Q152004000	TORNIL, APLASTADO M5x13 A304	FLAT HEADED BOLT M5x13 A304	2	2								
	Q302022000	ARANDELA 16x6x1,2 A304	WASHER 16x6x1,2 A304	2	2								
5	R042611000	ESCUADRA INTER. DE MESA 1/2M	INTER BRACKET. TABLE 1/2M	1	-								
5	U172618000	ESCUADRA INTER. DE MESA 1M	INTER BRACKET. TABLE 1 M	-	1								
	Q221342000	REMACHE EXAGONAL M5	HEXAGONAL RIVET M5	4	4								
	Q012032000	TORNILLO EXAGONAL M5x15 A304	HEXAGONAL BOLT M5x15	6	6								
	Q302022000	ARANDELA 16x6x1,2 A304	WASHER 16x6x1,2 A304	4	4								
	Q419005000	REMACHE 4x8 ALMG3 / ALUMINIO	RIVET 4X8 ALMG3 / ALUMINIUM	7	7								
	Q221341000	REMACHE EXAGONAL M4	HEXAGONAL RIVET M4	1	1								
	Q221345000	REMACHE EXAGONAL M10	HEXAGONAL RIVET M10	8	8								
6	U172815000	PORTAMANDOS CI9-20	CONTROL HOLDER CI9-20	1	-								
6	U172808000	PORTAMANDOS CI9-40	CONTROL HOLDER CI9-40	-	1								
	U022836000	ESCUDO FAGOR	FAGOR EMBLEM	1	1								
	Q221023000	CLIP SUJECIÓN RÁPIDA Ø5	RAPID CONNECT CLIP Ø5	2	2								
	Q152004000	TORNIL, APLASTADO M5x13 A304	FLAT HEADED BOLT M5x13 A304	2	2								
7	R062810000	PANEL LATERAL DERECHO	RIGHT SIDE PANEL	1	1								
	Q221343000	REMACHE EXAGONAL M6	HEXAGONAL RIVET M6	5	5								
	Q221342000	REMACHE EXAGONAL M5	HEXAGONAL RIVET M5	7	7								
8	U962627000	ESCUADRA AMARRE PATA AD	LEG FASTENING BRACKET AD	2	2								
	Q162030000	TUERCA EXAGONAL M5	HEXAGONAL NUT M5	4	4								
	Q302022000	ARANDELA 16x6x1,2 A304	WASHER 16x6x1,2 A304	4	4								
	X010503000	CIERRE MUELLE	LOCK SPRING	2	2								

MOD.	COCINAS / RANGES		ZONA / ZONE	MUEBLE / FITTING							PLANO DIAGRAM	C-2693	
ITEM	CODIGO REFERENCE	DENOMINACION	DENOMINATION	C19-20 PLUS	C19-40 PLUS						ELIMINADO ELIMINATED	INTRODUCID. INTRODUCED	NOTAS
9	U172627000	BASE COMPLETA CI9-05	COMPLETE BASE CI9-05	1	-								
9	U172628000	BASE COMPLETA CI9-40	COMPLETE BASE CI9-40	-	1								
	Q419005000	REMACHE 4x8 ALMG3 / ALUMINIO	RIVET 4X8 ALMG3 / ALUMINIUM	12	12								
10	Z200107000	PATA REGULABLE	ADJUSTABLE LEG	2	2								
11	R062805000	ZOCALO COMPLETO 1/2M	COMPLETE SKIRTING 1/2M	1	-								
11	H352817000	ZOCALO COMPLETO	COMPLETE SKIRTING	-	1								
	Q151336000	TORNILLO SOPORTE GUIAS	TORNILLO SOPORTE GUIAS	2	2								
	Q221343000	REMACHE EXAGONAL M6	HEXAGONAL RIVET M6	2	2								
	Q152004000	TORNIL, APLASTADO M5x13 A304	FLAT HEADED BOLT M5x13	2	2								
	Q302022000	ARANDELA 16x6x1,2 A304	WASHER 16x6x1,2 A304	2	2								
12	R062811000	PANEL LATERAL IZQUIERDO	LEFT SIDE PANEL	1	1								
	Q221343000	REMACHE EXAGONAL M6	HEXAGONAL RIVET M6	5	5								
	Q221342000	REMACHE EXAGONAL M5	HEXAGONAL RIVET M5	7	7								
13	Z200107000	PATA REGULABLE	ADJUSTABLE LEG	2	2								
14	R042838000	PANEL POSTERIOR 1/2M AD	REAR PANEL 1/2M AD	1	-								
14	U042805000	PANEL POSTERIOR 1M AD	REAR PANEL 1M AD	-	1								
	Q419005000	REMACHE 4x8 ALMG3 / ALUMINIO	RIVET 4X8 ALMG3 / ALUMINIUM	4	4								
	Q152004000	TORNIL, APLASTADO M5x13 A304	FLAT HEADED BOLT M5x13 A304	2	2								
	X010503000	CIERRE MUELLE	LOCK SPRING	2	2								
15	U172612000	SOPORTE OMEGA CI9-20	OMEGA CI9-20 SUPPORT	2	-								
15	U172613000	SOPORTE OMEGA CI9-40	OMEGA CI9-40 SUPPORT	-	2								
	Q419005000	REMACHE 4x8 ALMG3 / ALUMINIO	RIVET 4X8 ALMG3 / ALUMINIUM	8	8								
16	U172609000	SOPORTE CARRIER	CARRIER SUPPORT	2	4								
	Q419005000	REMACHE 4x8 ALMG3 / ALUMINIO	RIVET 4X8 ALMG3 / ALUMINIUM	4	8								
	Q221342000	REMACHE EXAGONAL M5	HEXAGONAL RIVET M5	4	8								
17	12046932	CORREAGUAS 0,5M	WATER COLLECT 0,5M	1	-							01,10,12	
17	12046955	CORREAGUAS 1M	WATER COLLECT 1M	-	1							01,10,12	

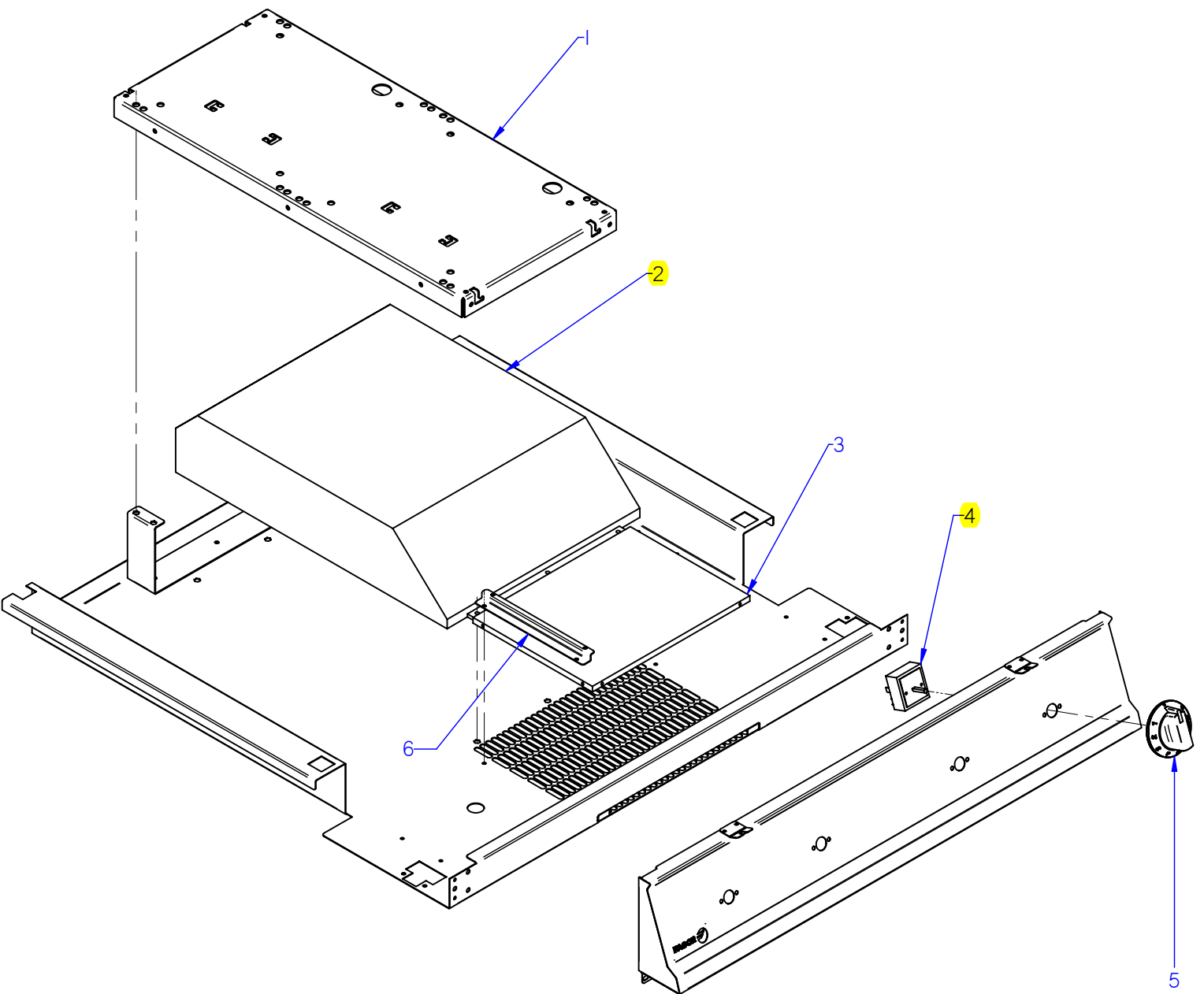

ITEM MARCADO EN COLOR = REPUESTO RECOMENDADO  
COLOURED ITEM = RECOMMENDED SPARE PART

Nº plano / N° plane	Firma	Fecha / Date	Denominación / Denomination:	Lamina / Sheet
C-2694		2011-03	COCINA / RANGES CI9-20 / CI9-40 PLUS PARTE FUNCIONAL ELECTRICA / ELECTRICAL FUNCTIONAL PART	2
<b>FAGOR</b> FAGOR INDUSTRIAL				

MOD.	COCINAS / RANGES		ZONA / ZONE	PARTE FUNCIONAL ELECTRICA ELECTRICAL FUNCTIONAL PART								PLANO DIAGRAM		C-2694
ITEM	CODIGO REFERENCE	DENOMINACION	DENOMINATION	C19-20 PLUS	C19-40 PLUS							ELIMINADO ELIMINATED	INTRODUCID. INTRODUCED	NOTAS
1	U172602000	BOBINA REDONDA	ROUND COIL	1	2									
	Q302022000	ARANDELA 16x6x1,2 A304	WASHER 16x6x1,2 A304	2	4									
	Q012032000	TORNILLO EXAGONAL M5x15 A304	HEXAGONAL BOLT M5x15	2	4									
2	U173015000	GENERADOR 2x5kW	GENERATOR 2x5kW	1	-									
2	U173014000	GENERADOR 4x5kW	GENERATOR 4x5kW	-	1									
3	U172624000	FILTRO CI9-40	CI9-40 FILTER	1	1									
4	U173016000	MANDO ROTATORIO CI	ROTATING KNOB CI	2	4									
	Q151320000	TORNILLO ALOMADO M4x6 H.ZINC	CURVED SCREW M4X6 H. ZINC	4	8									
5	S162102000	BOTON DE MANDO	CONTROL BUTTON	2	4									
6	U172617000	GUIA FILTRO CI-900	FILTER GUIDE CI-900	2	2									
	Q419005000	REMACHE 4x8 ALMG3 / ALUMINIO	RIVET 4X8 ALMG3 / ALUMINIUM	4	4									
	Q221342000	REMACHE EXAGONAL M5	HEXAGONAL RIVET M5	6	6									
S/Nº	R253044000	REGLETA AUXILIAR FV-122	AUXILIARY TERMINAL STRIP FV-	1	1									

<b>MOD.</b>	<b>COCINAS / RANGES</b>	<b>ZONA / ZONE</b>	<b>VARIOS / MISCELLANEOUS</b>	<b>PLANO DIAGRAM</b>	
-------------	-------------------------	--------------------	-------------------------------	--------------------------	--

<b>ITEM</b>	<b>CODIGO REFERENCE</b>	<b>DENOMINACION</b>	<b>DENOMINATION</b>	<b>C19-20 PLUS</b>	<b>C19-40 PLUS</b>							<b>ELIMINADO ELIMINATED</b>	<b>INTRODUCID. INTRODUCED</b>	<b>NOTAS</b>
	U176502000	FOLLETO DE INSTRUCCIONES CV	INSTRUCTION LEAFLET CV	1	1									
	U173020000	MANGUERA 2 x 6 mm2 SILICONA	HOSE 2 x 6 mm2 SILICONE	2	4									
	U173021000	MANGUERA 2 x 0,5 mm2 SILICONA	HOSE 2 x 0,5 mm2 SILICONE	2	4									
	X363017000	CABLE MANGUERA 5X2.5 FE-8-18	HOSE CABLE 5X2.5 FE-8-18	1	-									
	X393008000	CABLE MANGUERA 5X6MM2	HOSE CABLE 5X6MM2	-	1									
	12004421	ESQUEMA MONTAJE	ASSEMBLY DIAGRAM	1	1									PLANO HC-71229
NO INCLUYE ESQUEMA TEORICO, ESTA INTEGRADO EN KIT EGO				THE THEORETICAL DIAGRAM IS NOT INCLUDED AS IT IS GOUND THE WIT EGO KIT										



MOD.		COCINAS / RANGES	ZONA / ZONE	REPUESTOS RECOMENDADOS RECOMMENDED SPARE PART								PLANO DIAGRAM	
ITEM	CODIGO REFERENCE	DENOMINACION	DENOMINATION	C19-20 PLUS	C19-40 PLUS						ELIMINADO ELIMINATED	INTRODUCID. INTRODUCED	NOTAS
3	U175410000	ENCIMERA COMPLETA CI9-20	TOP CI9-20 COMPL.	1	-								C-2693
3	U175409000	ENCIMERA COMPLETA CI9-40	TOP CI9-40 COMPL.	-	1								C-2693
2	U173015000	GENERADOR 2x5kW	GENERATOR 2x5kW	1	-								C-2694
2	U173014000	GENERADOR 4x5kW	GENERATOR 4x5kW	-	1								C-2694
4	U173016000	MANDO ROTATORIO CI	ROTATING KNOB CI	2	4								C-2694

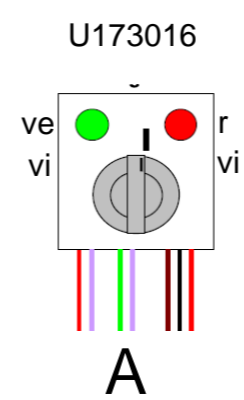
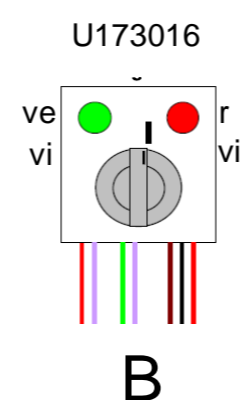
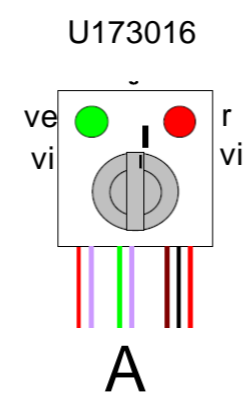
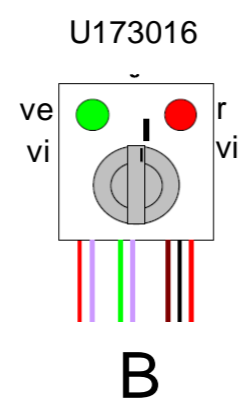
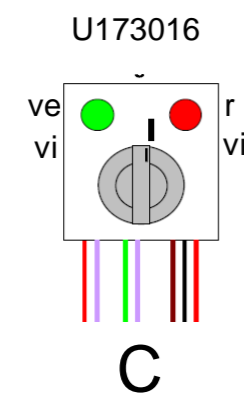
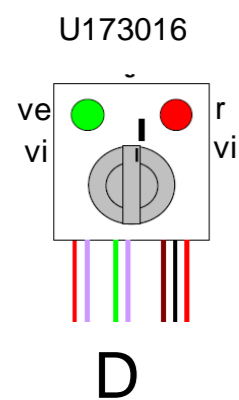

### CI 9-40

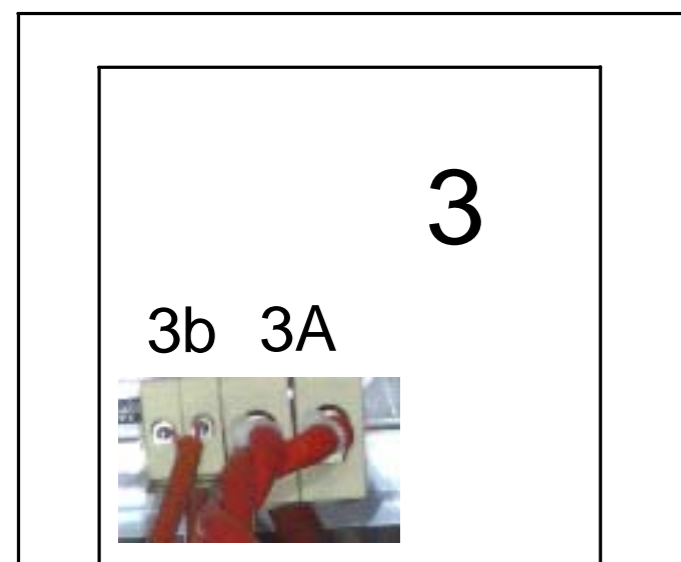

U172602

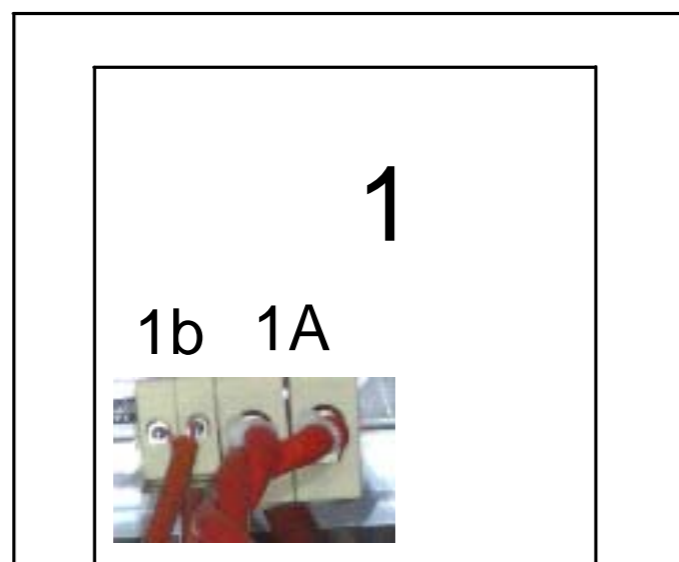

U172602

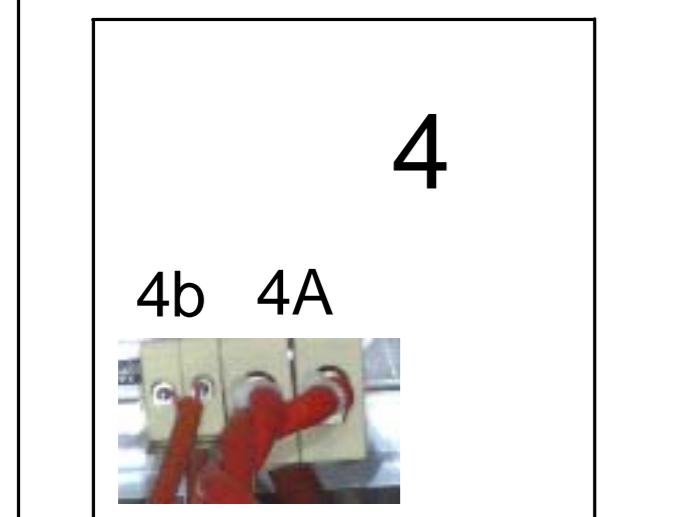

U175401

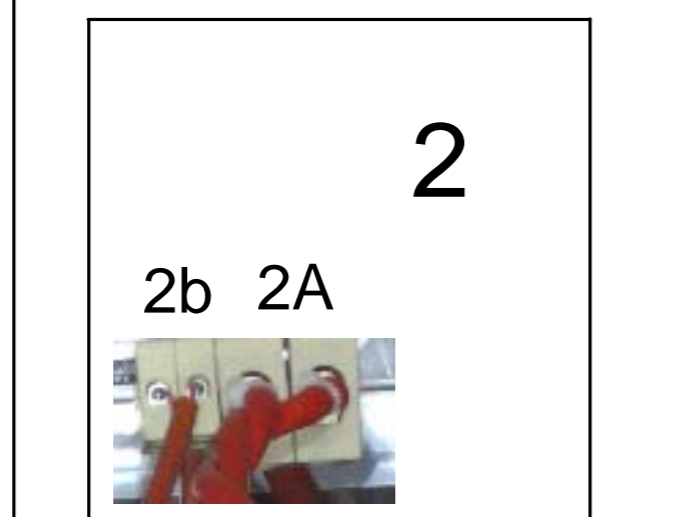

### CI 9-20

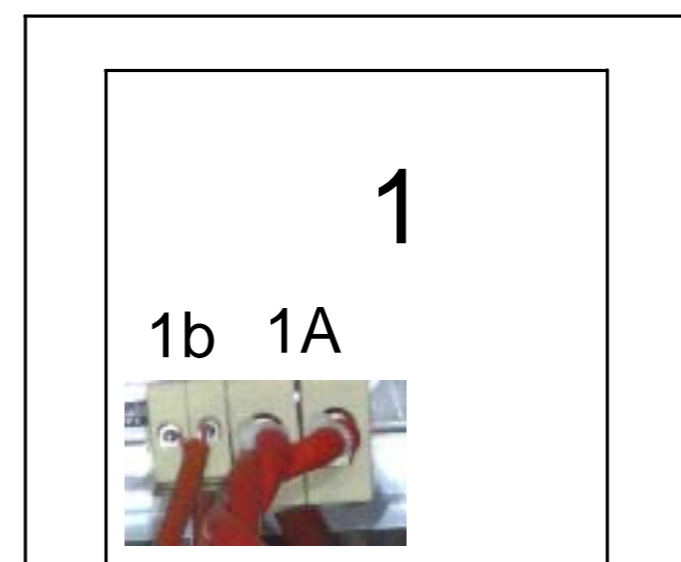

U172602

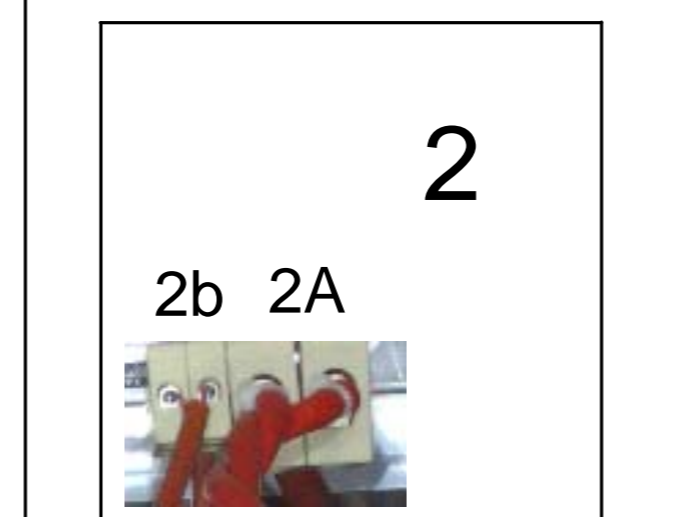

U175403

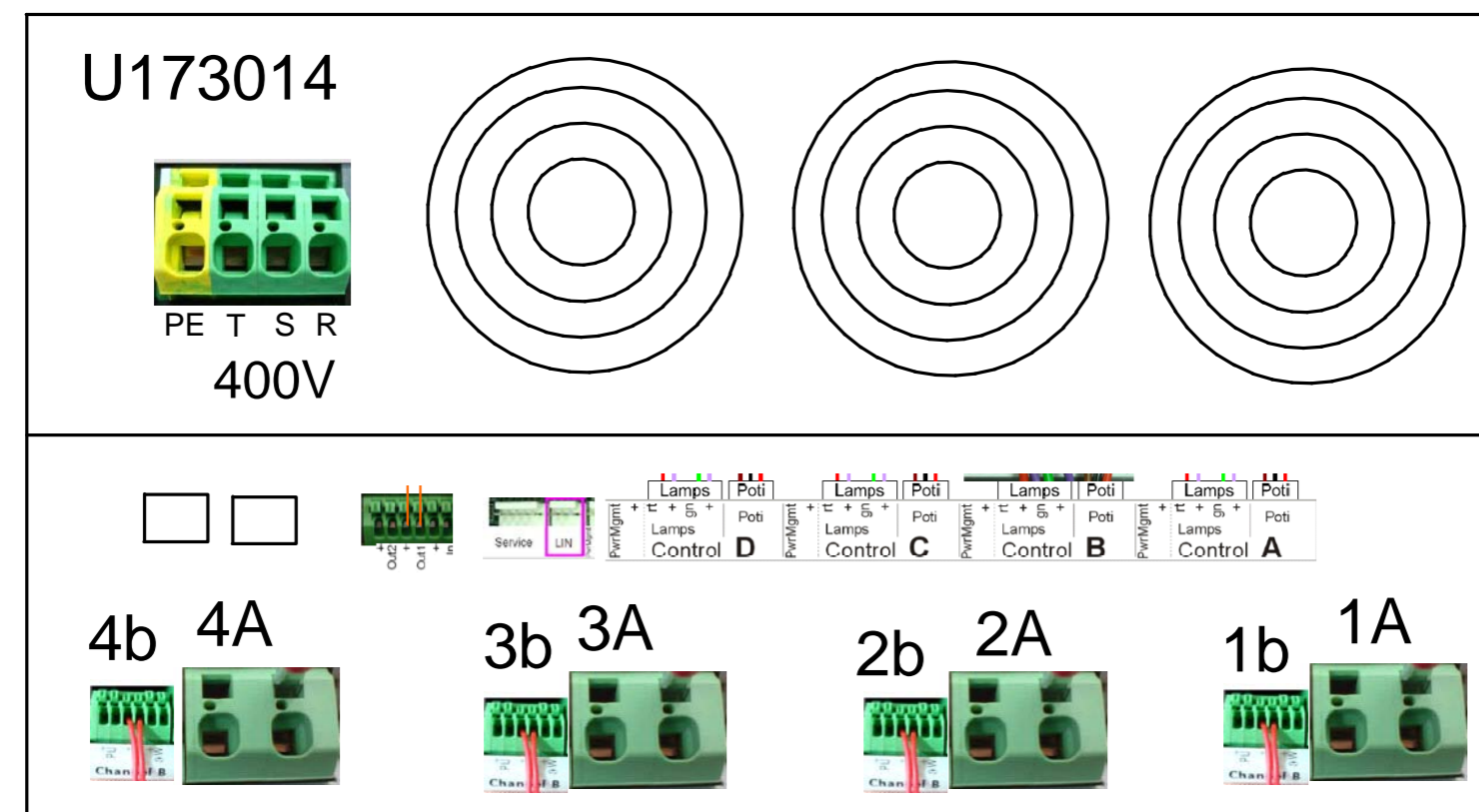

U173017 U173018 U173017 U173018 U173017 U173018 U173017 U173018

filtro 200x150x12 U172624

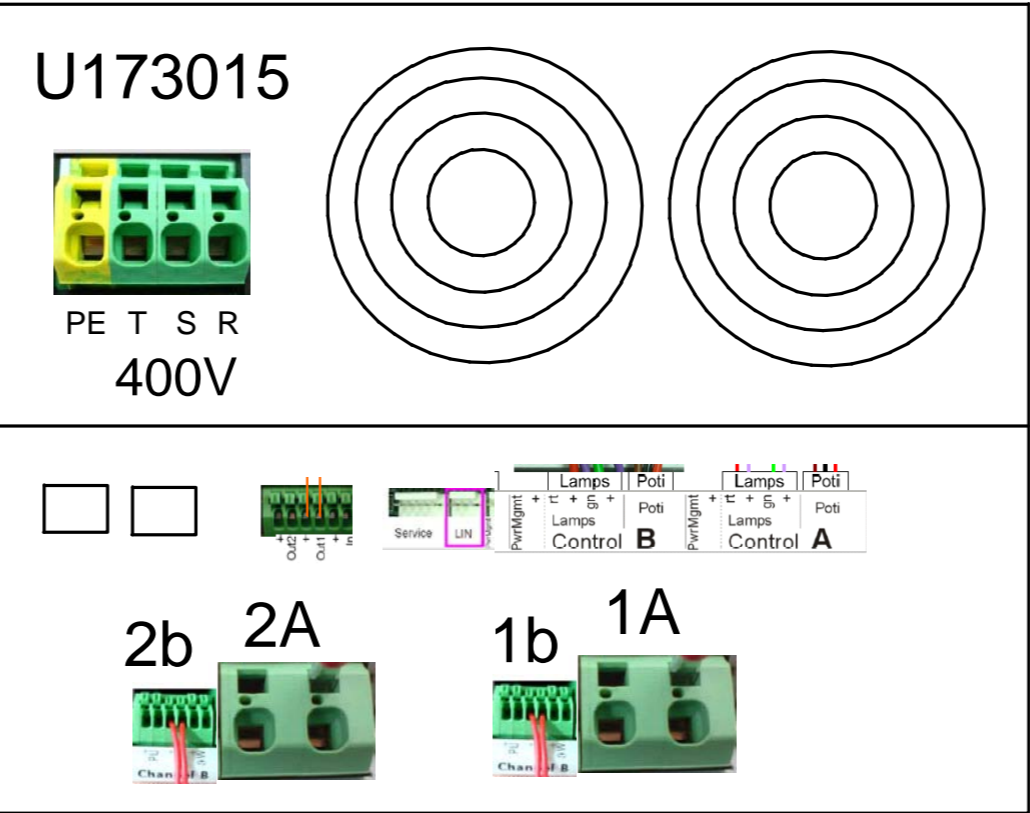

U173017 U173018 U173017 U173018

filtro 200x150x12 U172624

CI 920 Cable  
manguera 5x2.5mm<sup>2</sup>  
X363017

CI 940 Cable  
manguera 5x6mm<sup>2</sup>  
X393008

Plano Montaje Cocina de Induccion				U173019000		
Zk./Nº	Pieza	Cant.	Materia/Material	Klas. zk/Nº Clas.	Gainazal akabera/Tratamiento	
Zk./Nº	Aldaketa/Modificaciones		Nork proposatua/Propuesta de	Data/Fecha	Perdoi orokorrak Tolerancias generales	
-	-	-	-	-	< 5 ± 0.2	50 ± 100 ± 0.8
-	-	-	-	-	5 ± 25 ± 0.4	> 100 ± 1
-	-	-	-	-	25 ± 50 ± 0.6	α ± 1
				Sinadura/Firma	Data/Fecha	Gainazal perdoia Mecanizado superficial
Marrastua/Dibujado		M.Mailla	2010-0903	FAGOR		
Proiektatua/Proyectado		M.Mailla	2010-0903	Fagor Industrial, Koop. Elk. Mugatua		
Egiaztatua/Comprobado		ENERITZ	2010-0903			
Eskala/Escala				COCINAS		Plano Zk./Plano Nº HD -13207
						- Zk. ord. du
						- Zk.gaitik ord.

Plano hau ezin daiteke erabili, ez berrizatu, gure baimenik gabe.