

**Hornos Mixtos
Fours Mixtes
Combi Ovens
HeiBluftdämpfer
Forno Misti**

Modelos:

**HMI-6/11
HMI-10/11
HMI-10/21
HMI-2-10/11**

**MFHMI-6/11
MFHMI-10/11
MFHMI-10/21**

**HMI-6/11 UL
HMI-10/11 UL
HMI-10/21 UL**

**VEI-6/11
VEI-10/11
VEI-10/21
VEI-2-10/11**

Noviembre 2003 November



Fagor Industrial

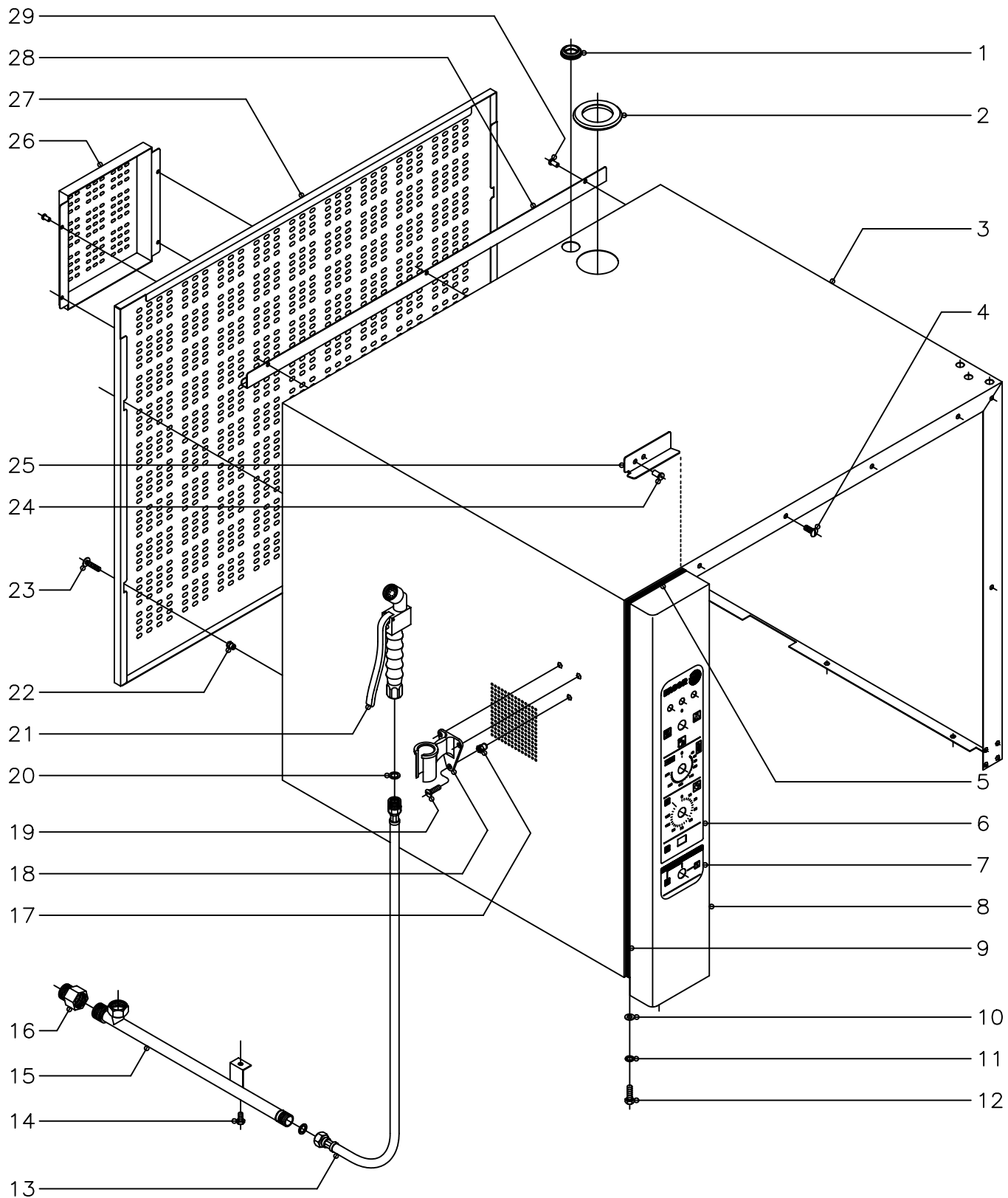

N plano C-1436	Firma <i>[Signature]</i>	Fecha 11-2003	Aparato MUEBLE HORNOS MIXTOS DE INYECCION	Lamina 1	Fagor Industrial S.Coop. FAGOR Ofite
-------------------	-----------------------------	------------------	---	-------------	--

MOD.		HORNOS MIXTOS DE INYECCION		ZONA	MUEBLE							PLANO	C-1436
ITEM	CODIGO	DENOMINACION	TEXTO	HMI-6/11	HMI-10/11	HMI-10/21	HMI-2-10/11	HMI-6/11 UL	HMI-10/11 UL	HMI-10/21 UL		NOTAS	
1	N503017	Soporte termostato		1	1	1	1	1	1	1		Pasamuros chimenea	
2	R662813	Pasamuros chimenea		1	1	1	1	1	1	1			
3	R662819	Cuerpo exterior de horno 6/11		1	-	-	-	1	-	-			
3	R672816	Cuerpo exterior de horno 10/11		-	1	-	-	-	1	-			
3	R682812	Cuerpo exterior de horno 10/21		-	-	1	1	-	-	1			
4	Q152017	Tornillo amarre M-6x13		6	6	6	6	6	6	6			
5	3715400	Junta panel portamandos L=130		1	1	1	1	1	1	1			
6	R693014	Serigrafia superior (FAGOR)		1	1	1	1	-	-	-			
6	R693075	Serigrafia superior (FAGOR - UL)		-	-	-	-	1	1	1			
6	R693030	Serigrafia superior (MF)		-	-	-	-	1	1	1			
7	R663014	Serigrafia inferior (FAGOR)		1	-	-	-	1	-	-			
7	R693000	Serigrafia inferior (FAGOR)		-	1	1	1	-	1	1			
7	R693057	Serigrafia inferior (MF)		-	-	-	-	1	-	-			
7	R693031	Serigrafia inferior (MF)		-	-	-	-	-	1	1			
8	R692814	Panel portamandos 6/11		1	-	-	-	1	-	-			
8	R702805	Panel portamandos 10/11 y 10/21		-	1	1	1	-	1	1			
9	3715400	Junta panel portamandos L=530		2	-	-	-	2	-	-			
9	3715400	Junta panel portamandos L=770		-	2	2	2	-	2	2			
10	Q232040	Arandela plana A-6		2	2	2	2	2	2	2			
11	Q262040	Arandela muelle A-6		2	2	2	2	2	2	2			
12	Q012042	Tornillo exagonal M-6x15		2	2	2	2	2	2	2			
13	R095006	Flexible de ducha		1	1	1	1	1	1	1		Opcional bajo pedido	
14	Q012042	Tornillo exagonal M-6x15		1	1	1	1	1	1	1		Opcional bajo pedido	
15	R675002	Suplemento ducha		1	1	-	-	1	1	-		Opcional bajo pedido	
15	R685003	Suplemento ducha		-	-	1	1	-	-	1		Opcional bajo pedido	
16	T125033	Adaptador a rosca UL		-	-	-	-	1	1	1		Poner el de la electroválvula	
17	Q221342	Remache exagonal M-4		3	3	3	3	3	3	3		Opcional bajo pedido	
18	R095007	Soporte de ducha		1	1	1	1	1	1	1		Opcional bajo pedido	
19	Q042022	Tornillo avellanado M-4x15		3	3	3	3	3	3	3		Opcional bajo pedido	

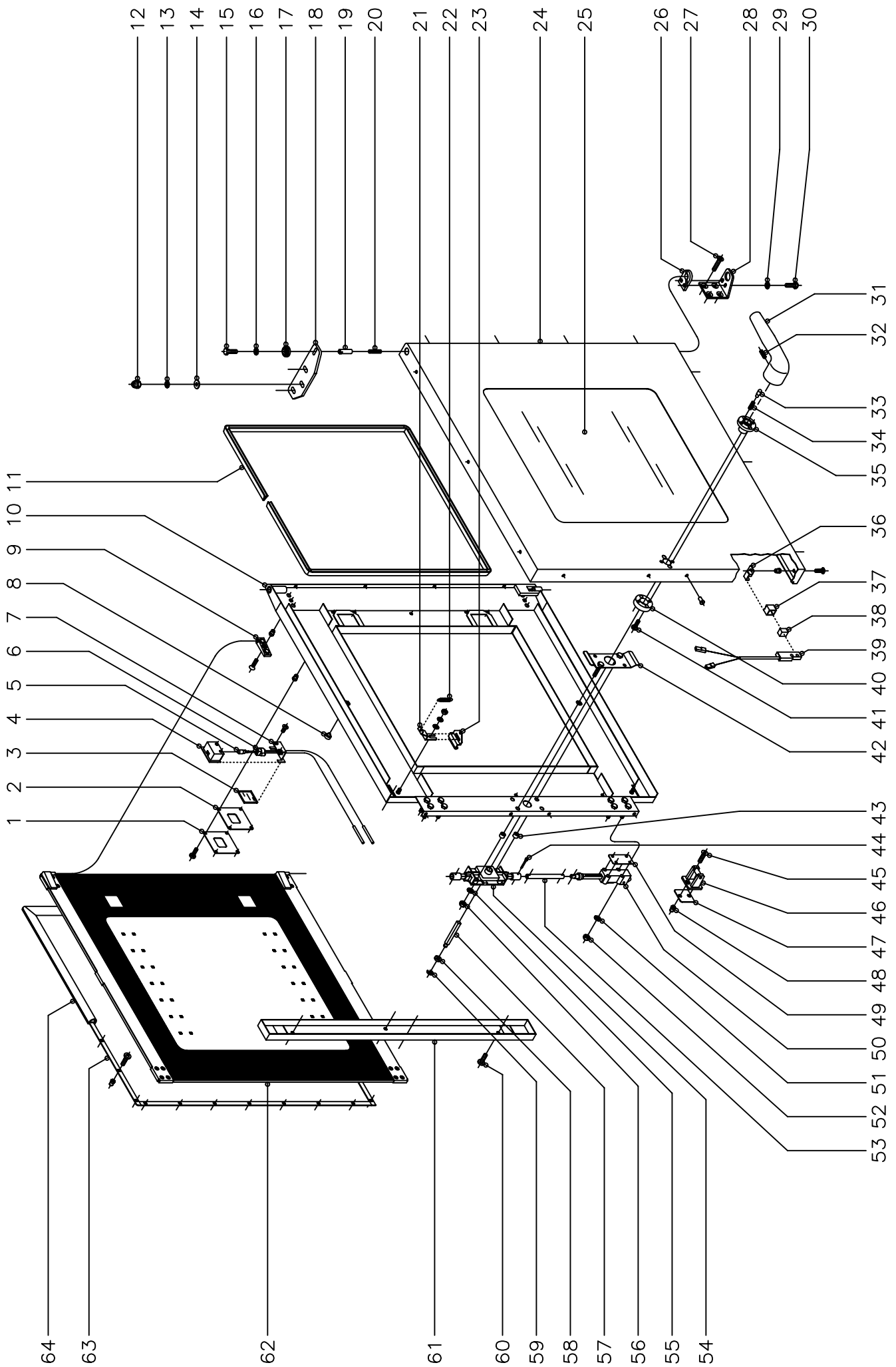

N plano
C-1437

Firma
[Signature]

Fecha
11-2003

Aparato
PUERTA
HORNOS MIXTOS DE INYECCION

Lamina
2

Fagor Industrial S.Coop. **FAGOR**
Ofate

MOD.		HORNOS MIXTOS DE INYECCION		ZONA	PUERTA							PLANO	C-1437
ITEM	CODIGO	DENOMINACION	TEXTO	HMI-6/11	HMI-10/11	HMI-10/21	HMI-2-10/11	HMI-6/11 UL	HMI-10/11 UL	HMI-10/21 UL			NOTAS
	1100002594	KIT Puerta completa 6/11		1	-	-	-	1	-	-			
	1100002595	KIT Puerta completa 10/11		-	1	-	-	-	1	-			
	1100002596	KIT Puerta completa 10/21		-	-	1	1	-	-	1			
1	R670608	Tapa cierre lampara		2	2	2	2	2	2	2			
	Q152004	Tornillo aplastado M-5x13		8	8	8	8	8	8	8			
	Q222011	Remache exagonal M-5		8	8	8	8	8	8	8			
2	R670609	Junta cierre lampara		2	2	2	2	2	2	2			
3	R670618	Cristal de lampara		2	2	2	2	2	2	2			
4	R670610	Deflector de lampara		2	2	2	2	2	2	2			
5	R663013	Lampara 10 W. 12 V.		2	2	2	2	2	2	2			
6	R663058	Portalamparas		2	2	2	2	2	2	2			
7	R670611	Suplemento deflector		2	2	2	2	2	2	2			
	Q042031	Tornillo avellanado M-5x10		4	4	4	4	4	4	4			
8	R670617	Tope cristal interior		6	6	6	6	6	6	6			
9	R670615	Base de bisagra		2	2	2	2	2	2	2			
	Q042032	Tornillo avellanado M-5x15		2	2	2	2	2	2	2			
	Q222011	Remache exagonal M-5		2	2	2	2	2	2	2			
10	T080500	Contrapuerta completa 6/11		1	-	-	-	1	-	-			
10	T110500	Contrapuerta completa 10/11		-	1	-	-	-	1	-			
10	T120500	Contrapuerta completa 10/21		-	-	1	1	-	-	1			
11	3715200	Junta cristal L=1700		1	-	-	-	1	-	-			
11	3715200	Junta cristal L=2000		-	1	-	-	-	1	-			
11	3715200	Junta cristal L=2300		-	-	1	1	-	-	1			
12	Q212051	Tuerca sombrerete M-8		3	3	3	3	3	3	3			
13	Q242050	Arandela abanico A-8		3	3	3	3	3	3	3			
14	Q302025	Arandela plana Ø8,4xØ20x1,5		3	3	3	3	3	3	3			
15	Q012042	Tornillo exagonal M-6x15		1	1	1	1	1	1	1			
16	Q242040	Arandela abanico A-6		1	1	1	1	1	1	1			

MOD.		HORNOS MIXTOS DE INYECCION		ZONA	PUERTA							PLANO	C-1437
ITEM	CODIGO	DENOMINACION	TEXTO	HMI-6/11	HMI-10/11	HMI-10/21	HMI-2-10/11	HMI-6/11 UL	HMI-10/11 UL	HMI-10/21 UL			NOTAS
17	R662807	Arandela amarre puerta		1	1	1	1	1	1	1			
18	T130500	Bisagra superior		1	1	1	1	1	1	1			
19	R660534	Eje superior		1	1	1	1	1	1	1			
20	Z850519	Resorte		1	1	1	1	1	1	1			
21	R670612	Base de pestillo		2	2	2	2	2	2	2			
	Q302022	Arandela plana Ø16xØ6x1,2		2	2	2	2	2	2	2			
	Q242040	Arandela abanico A-6		2	2	2	2	2	2	2			
	Q162040	Tuerca exagonal M-6		2	2	2	2	2	2	2			
22	R660605	Muelle tensor pestillo		2	2	2	2	2	2	2			
23	R670613	Pestillo sujecion cristal interior		2	2	2	2	2	2	2			
24	R660600	Panel puerta 6/11		1	-	-	-	1	-	-			
24	R670600	Panel puerta 10/11		-	1	-	-	-	1	-			
24	R680600	Panel puerta 10/21		-	-	1	1	-	-	1			
	Q412002	Remache tubular Ø4x7,5		14	14	14	14	14	14	14			
25	R660606	Cristal exterior 6/11		1	-	-	-	1	-	-			
25	R670625	Cristal exterior 10/11		-	1	-	-	-	1	-			
25	R680609	Cristal exterior 10/21		-	-	1	1	-	-	1			
26	R660549	Guia eje inferior		1	1	1	1	1	1	1			
27	Q062040	Tornillo avellanado M-6x16		4	4	4	4	4	4	4			
28	R660551	Bisagra inferior		1	1	1	1	1	1	1			
29	Q242040	Arandela abanico A-6		2	2	2	2	2	2	2			
30	Q012041	Tornillo exagonal M-6x10		2	2	2	2	2	2	2			
31	T130502	Manilla		1	1	1	1	1	1	1			
32	Q132042	Varilla roscada M-6x15		1	1	1	1	1	1	1			
33	T130507	Piton enganche		2	2	2	2	2	2	2			
34	T130506	Resorte		2	2	2	2	2	2	2			
35	T130515	Guia manilla		1	1	1	1	1	1	1			
36	T130513	Soporte iman		1	1	1	1	1	1	1			
37	Z200507	Protector iman		1	1	1	1	1	1	1			

MOD.		HORNOS MIXTOS DE INYECCION		ZONA	PUERTA							PLANO	C-1437
ITEM	CODIGO	DENOMINACION	TEXTO	HMI-6/11	HMI-10/11	HMI-10/21	HMI-2-10/11	HMI-6/11 UL	HMI-10/11 UL	HMI-10/21 UL			NOTAS
38	Z200506	Iman		1	1	1	1	1	1	1			
39	Z100522	Interruptor magnetico		1	1	1	1	1	1	1			
40	T130514	Soporte resortes		1	1	1	1	1	1	1			
41	Q032032	Tornillo alomado M-5x15		2	2	2	2	2	2	2			
42	T130511	Suplemento fijacion cerradura		1	1	1	1	1	1	1			
43	Z608410	Casquillo		2	2	2	2	2	2	2			
44	Q352001	Pasador de aletas Ø2x15		4	4	4	4	4	4	4			
45	Q042043	Tornillo avellanado M-6x20		4	4	4	4	4	4	4			
46	R260545	Enganche		2	2	2	2	2	2	2			
47	R660538	Calzo de enganche		4	4	4	4	4	4	4			
48	Q221343	Remache exagonal M-6		4	4	4	4	4	4	4			
49	T080503	Suplemento elemento cierre		6	6	6	6	6	6	6			
50	T080504	Elemento de cierre		2	2	2	2	2	2	2			
51	Q262040	Arandela muelle A-6		8	8	8	8	8	8	8			
52	Q162040	Tuerca exagonal M-6		8	8	8	8	8	8	8			
53	R020502	Tubo alargadera		-	2	2	2	-	2	2			
54	T130509	Mecanismo de cierre		1	1	1	1	1	1	1			
55	Q262040	Arandela muelle A-6		2	2	2	2	2	2	2			
56	Q162040	Tuerca exagonal M-6		2	2	2	2	2	2	2			
57	T130508	Eje de manilla		1	1	1	1	1	1	1			
58	T130505	Casquillo		1	1	1	1	1	1	1			
59	Q271033	Arandela de seguridad Ø6		1	1	1	1	1	1	1			
60	Q032031	Tornillo alomado M-5x10		2	2	2	2	2	2	2			
60	Q032021	Tornillo alomado M-4x10		2	2	2	2	2	2	2			
61	T080502	Tapa cierre puerta		1	-	-	-	1	-	-			
61	T110502	Tapa cierre puerta		-	1	1	1	-	1	1			
62	1100002806	KIT Cristal interior completo 6/11		1	-	-	-	1	-	-			
62	1100002807	KIT Cristal interior completo 10/11		-	1	-	-	-	1	-			
62	1100002808	KIT Cristal interior completo 10/21		-	-	1	1	-	-	1			

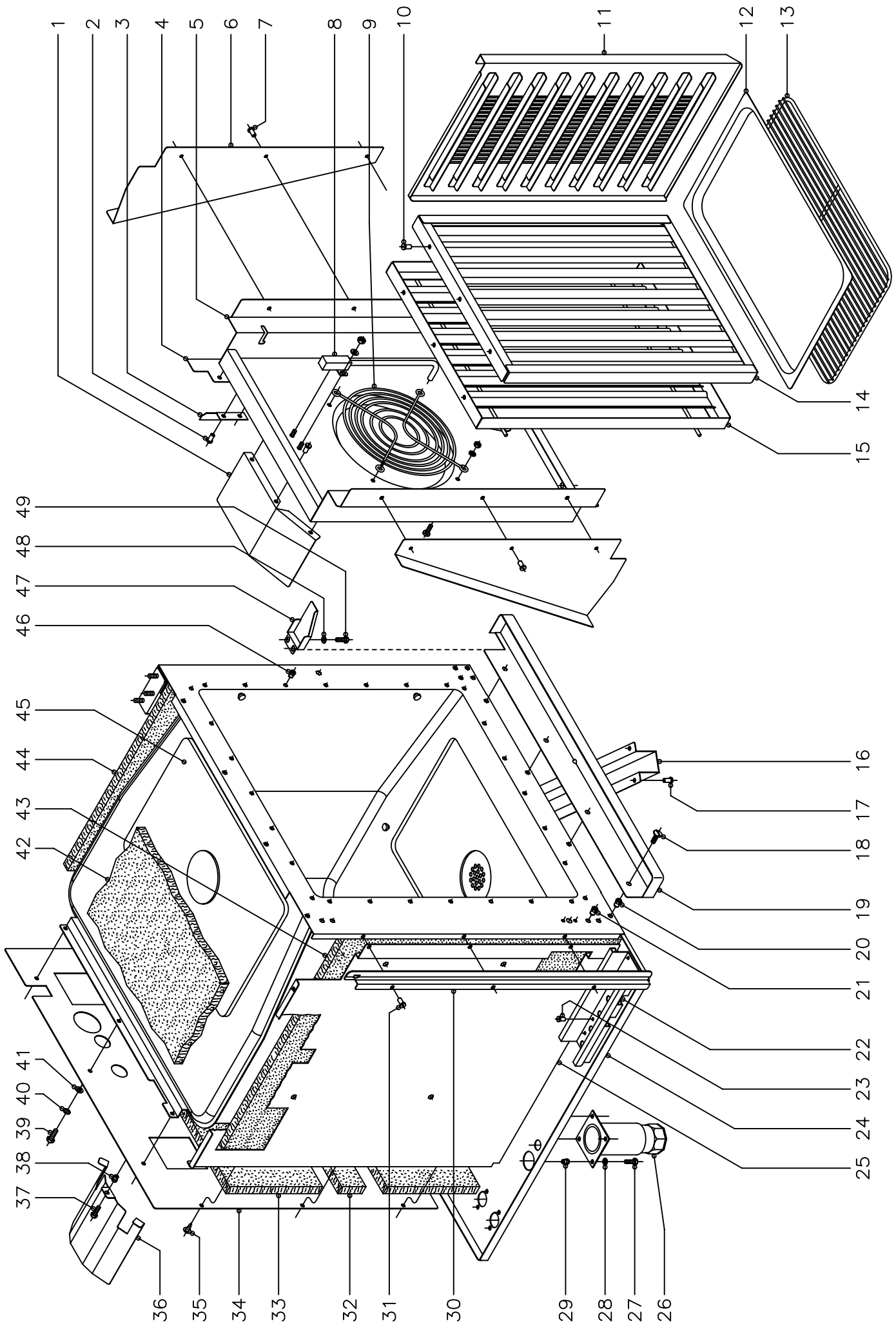

N plano C-1438	Firma 	Fecha 11-2003	Aparato MUEBLE INTERIOR HORNOS MIXTOS DE INYECCION	Lamina 3	Fagor Industrial S.Coop. FAGOR Onate
--------------------------	--	-------------------------	---	--------------------	--

MOD.		HORNOS MIXTOS DE INYECCION		ZONA	MUEBLE INTERIOR							PLANO	C-1438
ITEM	CODIGO	DENOMINACION	TEXTO	HMI-6/11	HMI-10/11	HMI-10/21	HMI-2-10/11	HMI-6/11 UL	HMI-10/11 UL	HMI-10/21 UL			NOTAS
1	R682632	Deflector de turbina		-	-	2	2	-	-	2			
	Q412002	Remache tubular Ø 4x7,5		-	-	6	6	-	-	6			
2	Q412002	Remache tubular Ø 4x7,5		4	4	4	4	4	4	4			
3	R292647	Escuadra sujecion cubreventilador		2	2	2	2	2	2	2			
4	R662648	Aleron derecho		1	-	-	-	1	-	-			
s/n	R662647	Aleron izquierdo		1	-	-	-	1	-	-			
5	R662656	Cubre ventilador		1	-	-	-	1	-	-			
5	R672651	Cubre ventilador		-	1	-	-	-	1	-			
5	R682669	Cubre ventilador		-	-	1	1	-	-	1			
6	R732619	Aleron lateral		-	-	2	2	-	-	2			
7	Q412002	Remache tubular Ø 4x7,5		-	-	6	6	-	-	6			
8	R665020	Tubo inyector		1	-	-	-	1	-	-			
8	R675017	Tubo inyector		-	1	1	1	-	1	1			
	Q232030	Arandela plana A-5		2	2	2	2	2	2	2			
	Q162030	Tuerca exagonal M-5		2	2	2	2	2	2	2			
9	R662661	Proteccion de turbina		-	-	-	-	1	1	1			
	Q032021	Tornillo alomado M-4x10		-	-	-	-	4	4	4			
	Q242020	Arandela abanico A-4		-	-	-	-	4	4	4			
	Q162020	Tuerca exagonal M-4		-	-	-	-	4	4	4			
10	Q412002	Remache tubular Ø 4x7,5		6	6	6	6	6	6	6			
11	R662668	Guia de bandejas derecha		1	-	-	-	1	-	-			
s/n	R662670	Guia de bandejas izquierda		1	-	-	-	1	-	-			
11	T112615	Guia de bandejas derecha		-	1	-	-	-	1	-			
s/n	T112617	Guia de bandejas izquierda		-	1	-	-	-	1	-			
11	T122614	Guia de bandejas derecha		-	-	1	-	-	-	-			
s/n	T122616	Guia de bandejas izquierda		-	-	1	-	-	-	-			
11	R682640	Guia de bandejas MARKET-FORGE		-	-	-	-	-	-	2			
12	R252816	Bandeja 1/1 (530x325x20)		1	1	-	1	-	-	-			
12	R032605	Bandeja 2/1 (530x650x40)		-	-	1	-	-	-	-			

MOD.	HORNOS MIXTOS DE INYECCION	ZONA	MUEBLE INTERIOR	PLANO	C-1438
------	-----------------------------------	------	------------------------	-------	---------------

ITEM	CODIGO	DENOMINACION	TEXTO	HMI-6/11	HMI-10/11	HMI-10/21	HMI-2-10/11	HMI-6/11 UL	HMI-10/11 UL	HMI-10/21 UL			NOTAS
13	R672665	Parrilla 1/1		1	1	-	1	3	5	-			
13	R682676	Parrilla 2/1		-	-	1	-	-	-	-			
13	R682641	Parrilla 2/1 MARKET-FORGE		-	-	-	-	-	-	5			
14	R662617	Anterior de filtro		1	-	-	-	1	-	-			
14	R092618	Anterior de filtro		-	1	1	1	-	1	1			
15	R662622	Posterior de filtro		1	-	-	-	1	-	-			
15	R092621	Posterior de filtro		-	1	1	1	-	1	1			
16	R672804	Cubre desagüe		1	1	-	-	1	1	-			
16	R682805	Cubre desagüe		-	-	1	1	-	-	1			
17	Q412002	Remache tubular Ø 4x7,5		8	8	8	8	8	8	8			
18	Q152017	Tornillo amarre M-6x13		4	4	4	4	4	4	4			
19	T112813	Recoge aguas		1	1	-	-	1	1	-			
19	T122811	Recoge aguas		-	-	1	1	-	-	1			
20	Q221343	Remache exagonal M-6		4	4	4	4	4	4	4			
21	Q221343	Remache exagonal M-6		8	8	8	8	8	8	8			
22	R342821	Guia del cuadro electrico		1	1	1	1	1	1	1			
23	Q412002	Remache tubular Ø 4x7,5		8	8	8	8	8	8	8			
24	R672813	Base exterior de horno		1	1	-	-	1	1	-			
24	R682811	Base exterior de horno		-	-	1	1	-	-	1			
25	T072614	Soporte lateral aislante		1	-	-	-	1	-	-			
25	T112624	Soporte lateral aislante		-	1	-	-	-	1	-			
25	T122619	Soporte lateral aislante		-	-	1	1	-	-	1			
26	X260151	Pata regulable		4	4	4	4	4	4	4			
27	Q012042	Tornillo exagonal M-6x15		16	16	16	16	16	16	16			
28	Q242040	Arandela abanico A-6		16	16	16	16	16	16	16			
29	Q221343	Remache exagonal M-6		16	16	16	16	16	16	16			
30	R662682	Protector portamandos		1	-	-	-	1	-	-			
30	R672674	Protector portamandos		-	1	1	1	-	1	1			
31	Q412002	Remache tubular Ø 4x7,5		3	3	3	3	3	3	3			

MOD.		HORNOS MIXTOS DE INYECCION		ZONA	MUEBLE INTERIOR							PLANO	C-1438
ITEM	CODIGO	DENOMINACION	TEXTO	HMI-6/11	HMI-10/11	HMI-10/21	HMI-2-10/11	HMI-6/11 UL	HMI-10/11 UL	HMI-10/21 UL			NOTAS
32	R662616	Aislante posterior 560x60x20		3	3	4	4	3	3	4			
33	R662615	Aislante posterior 800x110x20		2	-	-	-	2	-	-			
33	R672631	Aislante posterior 670x230x20		-	2	2	2	-	2	2			
34	R662655	Soporte aislante posterior		1	-	-	-	1	-	-			
34	R672608	Soporte aislante posterior		-	1	-	-	-	1	-			
34	R682606	Soporte aislante posterior		-	-	1	1	-	-	1			
35	Q151301	Tornillo alomado		3	3	3	3	3	3	3			
36	R142628	Tejadillo motor turbina		1	1	1	1	1	1	1			
37	Q012042	Tornillo exagonal M-6x15		1	1	1	1	1	1	1			
38	Q221343	Remache exagonal M-6		1	1	1	1	1	1	1			
39	Q012042	Tornillo exagonal M-6x15		12	12	12	12	12	12	12			
40	Q262040	Arandela muelle A-6		12	12	12	12	12	12	12			
41	Q232040	Arandela plana A-6		12	12	12	12	12	12	12			
42	R662614	Aislante base y techo 650x650x20		5	5	-	-	5	5	-			
42	R682623	Aislante base y techo 860x790x20		-	-	5	5	-	-	5			
43	R662613	Aislante lateral 650x530x20		3	-	-	-	3	-	-			
43	R672630	Aislante lateral 770x650x20		-	3	-	-	-	3	-			
43	R682623	Aislante lateral 860x790x20		-	-	3	3	-	-	3			
44	R662613	Aislante lateral 650x530x20		2	-	-	-	2	-	-			
44	R672630	Aislante lateral 770x650x20		-	2	-	-	-	2	-			
44	R682623	Aislante lateral 860x790x20		-	-	2	2	-	-	2			
45	R692610	Cuerpo interior horno		1	-	-	-	1	-	-			
45	R702605	Cuerpo interior horno		-	1	-	-	-	1	-			
45	R712615	Cuerpo interior horno		-	-	1	1	-	-	1			
	R662636	Refuerzo base de cuerpo interior		1	1	-	-	1	1	-			
	R682633	Refuerzo base de cuerpo interior		-	-	1	1	-	-	1			
	R682663	Refuerzo vertical de cuerpo interior		-	-	2	2	-	-	2			
	Q232040	Arandela plana A-6		8	8	21	21	8	8	21			Amarre refuerzos
	Q262040	Arandela muelle A-6		8	8	21	21	8	8	21			Amarre refuerzos

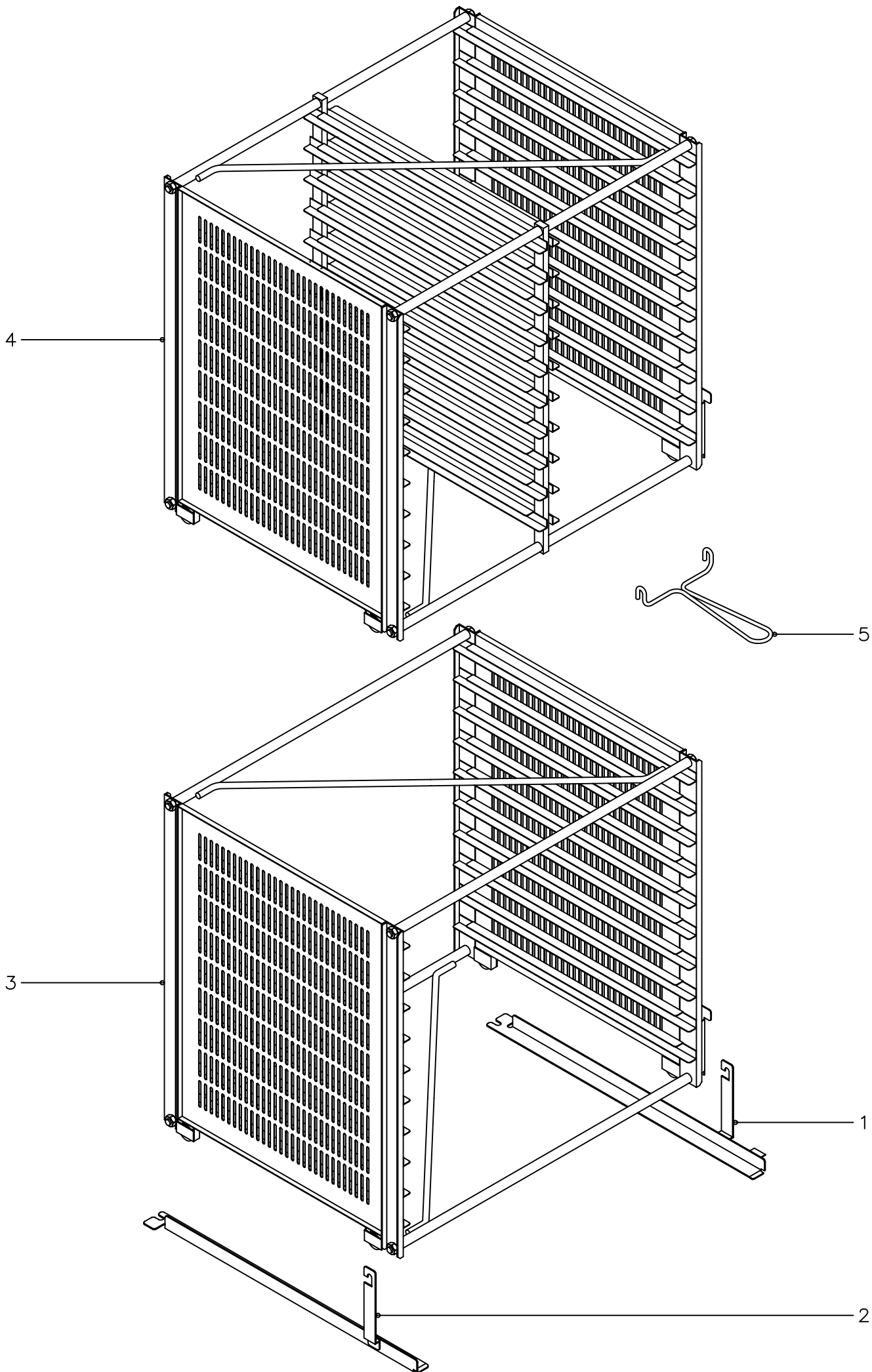

N plano
C-1439

Firma

Fecha
11-2003

Aparato
EXTRACTURAS PORTABANDEJAS
HORNOS MIXTOS DE INYECCION

Lamina
4

Fagor Industrial S.Coop. **FAGOR** 
Oñate

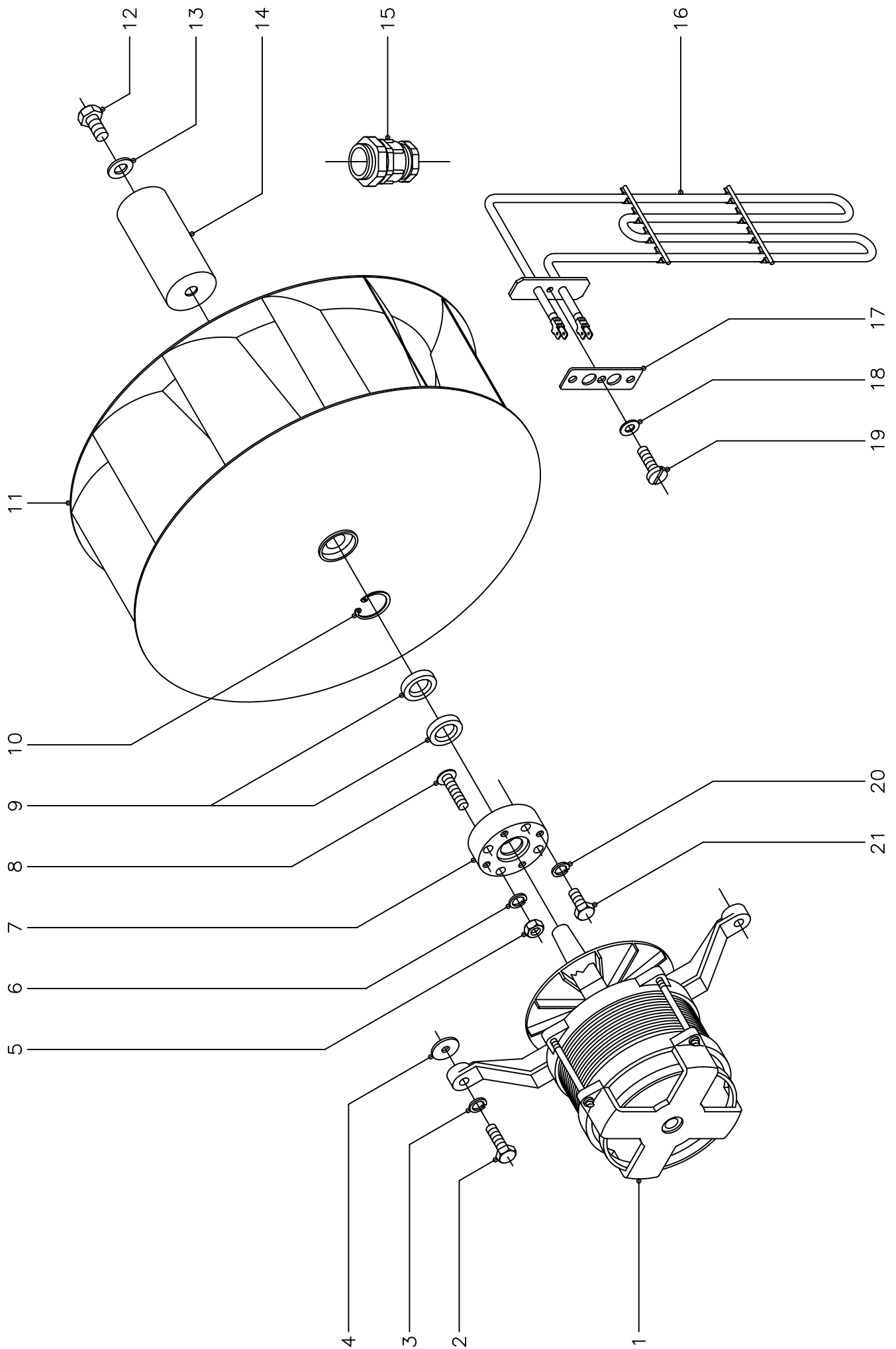

N plano C-1440	Firma 	Fecha 11-2003	Aparato TURBINA HORNOS MIXTOS DE INYECCION	Lamina 5	Fagor Industrial S.Coop. FAGOR Oñate
-------------------	--	------------------	--	-------------	--

MOD.		HORNOS MIXTOS DE INYECCION		ZONA	TURBINA							PLANO	C-1440
ITEM	CODIGO	DENOMINACION	TEXTO	HMI-6/11	HMI-10/11	HMI-10/21	HMI-2-10/11	HMI-6/11 UL	HMI-10/11 UL	HMI-10/21 UL			NOTAS
1	R253049	Conj. motor (230/400 V., 50/60 Hz.)		1	1	1	1	1	1	1			
2	Q012044	Tornillo exagonal M-6x25		4	4	4	4	4	4	4			
3	Q262040	Arandela muelle A-6		4	4	4	4	4	4	4			
4	Q301304	Arandela calzo Ø 23xØ 6,5x2		8	8	8	8	8	8	8			
5	Q162040	Tuerca exagonal M-6		4	4	4	4	4	4	4			
6	Q262040	Arandela muelle A-6		4	4	4	4	4	4	4			
7	R662623	Casquillo reten		1	1	1	1	1	1	1			
8	-	Perno M-6 (Caldeado a cuerpo)		4	4	4	4	4	4	4			
9	R662627	Reten Ø 28xØ 17x7		2	2	2	2	2	2	2			
10	Q302023	Anillo de seguridad Ø 28x1,2		1	1	1	1	1	1	1			
11	R253042	Turbina		1	1	1	1	1	1	1			
12	Q012063	Tornillo exagonal M-10x20		1	1	1	1	1	1	1			
13	R763010	Arandela seguridad Hanning		1	1	1	1	1	1	1			
14	R665025	Distribuidor inyeccion		1	1	1	1	1	1	1			
15	R033002	Prensaestopas		1	1	1	1	1	1	1			
16	R663016	Resistencia 1500W., 230V.		6	-	-	-	6	-	-			
16	R673002	Resistencia 1500+1500W., 230V.		-	6	-	-	-	6	-			
16	R683000	Resistencia 2000+2000W., 230V.		-	-	6	6	-	-	6			
17	R693017	Junta resistencia 6/11		6	-	-	-	6	-	-			
17	R673063	Junta resistencia 10/11 y 10/21		-	6	6	6	-	6	6			
18	Q232030	Arandela plana A-5		6	18	18	18	6	18	18			
19	Q062031	Tornillo alomado M-5x10		6	18	18	18	6	18	18			
20	Q232030	Arandela muelle A-5		4	4	4	4	4	4	4			
21	Q012031	Tornillo exagonal M-5x10		4	4	4	4	4	4	4			

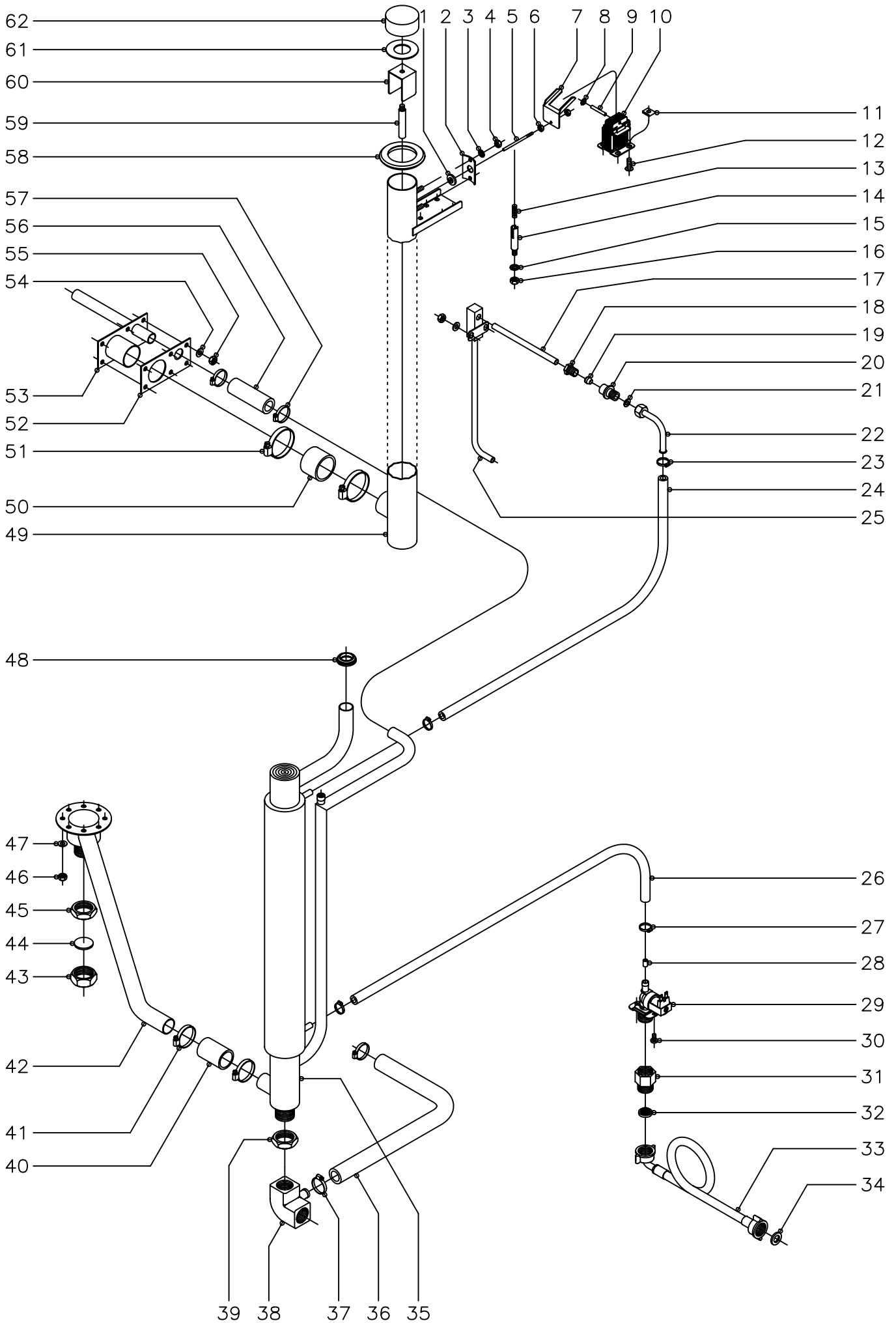

MOD.		HORNOS MIXTOS DE INYECCION		ZONA	CIRCUITO DE AGUA							PLANO	C-1441
ITEM	CODIGO	DENOMINACION	TEXTO	HMI-6/11	HMI-10/11	HMI-10/21	HMI-2-10/11	HMI-6/11 UL	HMI-10/11 UL	HMI-10/21 UL			NOTAS
1	R675033	Junta palanca accionamiento		1	1	1	1	1	1	1			
2	T115105	Amarre junta a conduccion vahos		1	1	1	1	1	1	1			
3	Q242030	Arandela abanico A-5		2	2	2	2	2	2	2			
4	Q162030	Tuerca exagonal M-5		2	2	2	2	2	2	2			
5	R675014	Palanca accionamiento		1	1	1	1	1	1	1			
6	Q162020	Tuerca exagonal M-4		2	2	2	2	2	2	2			
7	R672640	Escuadra accionamiento		1	1	1	1	1	1	1			
8	Q301035	Sujecion rapida Ø4		2	2	2	2	2	2	2			
9	R675016	Pasador electroiman		1	1	1	1	1	1	1			
10	R663030	Electroiman		1	1	1	1	1	1	1			
11	Q221012	Tuerca rapida M-5		2	2	2	2	2	2	2			
12	Q152004	Tornillo aplastado M-5x13		2	2	2	2	2	2	2			
13	Z883001	Resorte		1	1	1	1	1	1	1			
14	R665027	Guia resorte		1	1	1	1	1	1	1			
15	Q242040	Arandela abanico A-6		1	1	1	1	1	1	1			
16	Q162040	Tuerca exagonal M-6		1	1	1	1	1	1	1			
17	R665024	Tubo conduccion a inyector		1	1	1	1	1	1	1			
18	R695003	Manguito cierre		1	1	1	1	1	1	1			
19	R695004	Bicono		1	1	1	1	1	1	1			
20	-	Soldado a cuerpo de horno		1	1	1	1	1	1	1			
21	Q306025	Arandela junta Ø14xØ8,5x1,5		1	1	1	1	1	1	1			
22	R695017	Tubo conduccion agua		1	1	1	1	1	1	1			
23	Q881302	Abrazadera 12 - 20		2	2	2	2	2	2	2			
24	3676900	Tubo de goma Ø17xØ10x1000		1	1	1	1	1	1	1			
25	R665020	Tubo inyector		1	-	-	-	1	-	-			
25	R675017	Tubo inyector		-	1	1	1	-	1	1			
	Q232030	Arandela plana A-5		2	2	2	2	2	2	2			
	Q162030	Tuerca exagonal M-5		2	2	2	2	2	2	2			
26	3676900	Tubo de goma Ø17xØ10x1000		1	1	1	1	1	1	1			

MOD.		HORNOS MIXTOS DE INYECCION		ZONA	CIRCUITO DE AGUA							PLANO	C-1441
ITEM	CODIGO	DENOMINACION	TEXTO	HMI-6/11	HMI-10/11	HMI-10/21	HMI-2-10/11	HMI-6/11 UL	HMI-10/11 UL	HMI-10/21 UL			NOTAS
27	Q881302	Abrazadera 12 - 20		2	2	2	2	2	2	2			
28	R665041	Regulador caudal (0,25 l/m) verde		1	1	-	-	1	1	-			
28	R715011	Regulador caudal (0,50 l/m) rojo		-	-	1	1	-	-	1			
29	Z701135	Electrovalvula simple		1	1	1	1	1	1	1			
30	Q032021	Tornillo alomado M-4x10		2	2	2	2	2	2	2			
31	T125033	Adaptador a rosca UL		-	-	-	-	1	1	1			
32	Z701132	Filtro-junta entrada de agua		1	1	1	1	1	1	1			
33	Z601114	Manguera entrada de agua		1	1	1	1	-	-	-			
34	Q307031	Arandela junta Ø24xØ14x3		1	1	1	1	1	1	1			
35	R695025	Tubo retorno y chimenea		1	-	-	-	1	-	-			
35	R705020	Tubo retorno y chimenea		-	1	-	-	-	1	-			
35	R715010	Tubo retorno y chimenea		-	-	1	1	-	-	1			
36	3715600	Tubo silicona forra. Ø26xØ18x1000		1	1	1	1	1	1	1			
37	Q881304	Abrazadera 20 - 32		2	2	2	2	2	2	2			
38	R665067	Codo desague		1	1	1	1	1	1	1			
39	Q223014	Contratuerca 1"		1	1	1	1	1	1	1			
40	3714100	Tubo silicona Ø38xØ31x100		1	1	1	1	1	1	1			
41	Q881305	Abrazadera 25 - 40		2	2	2	2	2	2	2			
42	R675022	Tubo de desague		1	1	-	-	1	1	-			
42	R685006	Tubo de desague		-	-	1	1	-	-	1			
43	R665053	Tuerca tapon 1"		1	1	1	1	1	1	1			
44	R015011	Arandela junta tapon Ø34x3		1	1	1	1	1	1	1			
45	Q223014	Contratuerca 1"		1	1	1	1	1	1	1			
46	Q162040	Tuerca exagonal M-6		8	8	8	8	8	8	8			
47	Q232040	Arandela plana A-6		8	8	8	8	8	8	8			
48	N503017	Soporte termostato		1	1	1	1	1	1	1			Pasamuros chimenea
49	R695008	Conjunto chimenea		1	1	1	1	1	1	1			
50	3710900	Tubo silicona Ø51xØ43x40		1	1	1	1	1	1	1			
51	Q881307	Abrazadera 40 - 60		2	2	2	2	2	2	2			

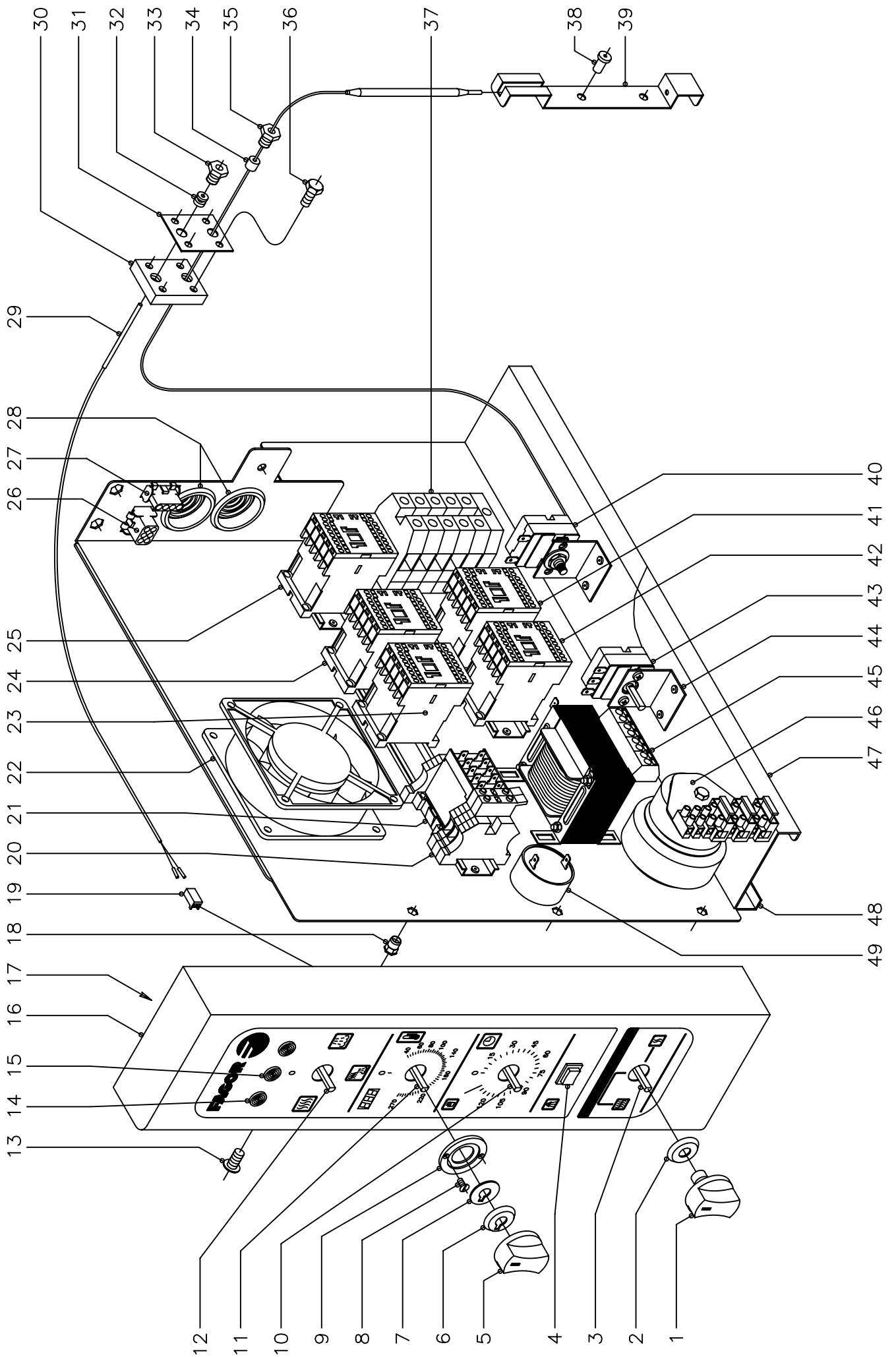

MOD.		HORNOS MIXTOS DE INYECCION		ZONA	PARTE FUNCIONAL ELECTRICA							PLANO	C-1442
ITEM	CODIGO	DENOMINACION	TEXTO	HMI-6/11	HMI-10/11	HMI-10/21	HMI-2-10/11	HMI-6/11 UL	HMI-10/11 UL	HMI-10/21 UL			NOTAS
1	R663062	Boton de mando (conmutadores)		2	3	3	3	2	3	3			FAGOR
1	R663070	Boton de mando (conmutadores)		-	-	-	-	2	3	3			MARKET-FORGE
2	R663046	Junta (conmutadores)		2	3	3	3	2	3	3			
3	R753000	Conmutador de potencia		-	1	1	1	-	1	1			
4	R663032	Pulsador humidificador		1	1	1	1	1	1	1			
5	R663063	Boton de mando (circuito impreso)		1	1	1	1	1	1	1			FAGOR
5	R663071	Boton de mando (circuito impreso)		-	-	-	-	1	1	1			MARKET-FORGE
6	R663045	Junta (circuito impreso)		1	1	1	1	1	1	1			
7	R662810	Arandela guia		1	1	1	1	1	1	1			
8	Q151346	Tornillo avellanado M-3x5		2	2	2	2	2	2	2			
9	R662809	Guia boton de mando		1	1	1	1	1	1	1			
10	R723000	Temporizador manual		1	1	1	1	1	1	1			
11	R743013	Termostato electronico 270°C.		1	1	1	1	-	-	-			
11	R693058	Termostato electronico 500°F.		-	-	-	-	1	1	1			
12	R693004	Conmutador de funciones		1	1	1	1	1	1	1			
13	Q152004	Tornillo aplastado M-5x13		3	3	3	3	3	3	3			
14	R693056	Piloto ambar		2	2	2	2	2	2	2			
15	R693055	Piloto verde		1	1	1	1	1	1	1			
16	R692814	Panel portamandos 6/11		1	-	-	-	1	-	-			
16	R702805	Panel portamandos 10/11 y 10/21		-	1	1	1	-	1	1			
17	R692806	Soporte componentes		1	1	1	1	1	1	1			
18	Q221342	Remache exagonal M-5		3	3	3	3	3	3	3			
19	R663092	Conector 2 vias		1	1	1	1	1	1	1			
20	R073005	Bornas portafusibles		2	2	2	2	2	2	2			
	P184011	Cartucho fusible 4 A.		2	2	2	2	2	2	2			
	Z263303	Tope final		1	1	1	1	1	1	1			
21	Z683087	Contactador 3TF20 01 - 3AL2 (230 V.)		1	1	1	1	1	1	1			
	Z263303	Tope final		1	1	1	1	1	1	1			
22	Z103066	Ventilador		1	1	1	1	1	1	1			

MOD.		HORNOS MIXTOS DE INYECCION		ZONA	PARTE FUNCIONAL ELECTRICA							PLANO	C-1442
ITEM	CODIGO	DENOMINACION	TEXTO	HMI-6/11	HMI-10/11	HMI-10/21	HMI-2-10/11	HMI-6/11 UL	HMI-10/11 UL	HMI-10/21 UL			NOTAS
23	Z203050	Contactador sirius 3RT-1016-2AP01		-	1	1	1	-	1	1			
24	Z203050	Contactador sirius 3RT-1016-2AP01		1	1	1	1	1	1	1			
	R693009	Guia contactor 250		1	1	1	1	1	1	1			
25	Z203050	Contactador sirius 3RT-1016-2AP01		1	1	1	1	1	1	1			
	Z403016	Guia contactor 100		1	1	1	1	1	1	1			
26	-	Conector hembra 6 vias		1	1	1	1	1	1	1			
27	-	Conector hembra 4 vias		1	1	1	1	1	1	1			
28	N103013	Pasacables		2	2	2	2	2	2	2			
29	R663090	Conjunto termopar L=1500		1	1	1	1	1	1	1			
30	R662659	Pasamuros doble para sonda		1	1	1	1	1	1	1			
31	R692811	Junta pasamuros doble		1	1	1	1	1	1	1			
32	R662652	Bicono cierre sonda		1	1	1	1	1	1	1			
33	R662629	Racord cierre sonda		1	1	1	1	1	1	1			
34	R662662	Junta cierre bulbo limitador		1	1	1	1	1	1	1			
35	R662629	Racord cierre sonda		1	1	1	1	1	1	1			
36	Q012021	Tornillo exagonal M-4x10		4	4	4	4	4	4	4			
37	P453025	Borne gris fases 10		3	-	-	-	3	-	-			
	R263003	Borne gris fases 35		-	3	3	3	-	3	3			
	Z263302	Borne azul neutro 10		1	-	-	-	1	-	-			
	R673010	Borne azul neutro 35		-	1	1	1	-	1	1			
	P453026	Borne verde-amarillo tierra 10		1	-	-	-	1	-	-			
	Z103035	Borne verde-amarillo tierra 35		-	1	1	1	-	1	1			
	Z263303	Tope final		1	-	-	-	1	-	-			
	Z683096	Tope final 35		-	1	1	1	-	1	1			
	Z683068	Señalizacion bornes		1	1	1	1	1	1	1			
	R663055	Guia contactor 120		1	1	1	1	1	1	1			
38	Q412002	Remache tubular Ø4x7,5		2	2	2	2	2	2	2			
39	R662630	Soporte de bulbo		1	1	1	1	1	1	1			
40	R243016	Termostato limitador temperatura		1	1	1	1	1	1	1			

MOD.		HORNOS MIXTOS DE INYECCION		ZONA	VARIOS							PLANO
ITEM	CODIGO	DENOMINACION	TEXTO	HMI-6/11	HMI-10/11	HMI-10/21	HMI-2-10/11	HMI-6/11 UL	HMI-10/11 UL	HMI-10/21 UL		NOTAS
	R696501	Folleto de instrucciones (FAGOR)		1	1	1	1	1	1	1		
	R696503	Folleto de instrucciones (M F)		-	-	-	-	1	1	1		
	R693069	Esquema electrico adhesivo		1	-	-	-	-	-	-		Plano HC-73226
	R693076	Esquema electrico adhesivo (MF)		-	-	-	-	1	-	-		Plano HC-74736
	R693077	Esquema electrico adhesivo (UL)		-	-	-	-	1	-	-		Plano HC-74746
	R703015	Esquema electrico adhesivo		-	1	1	1	-	-	-		Plano HC-73227
	R703027	Esquema electrico adhesivo (MF)		-	-	-	-	-	1	1		Plano HC-74737
	R703028	Esquema electrico adhesivo (UL)		-	-	-	-	-	1	1		Plano HC-74747
	R693070	Esquema electrico de montaje		1	-	-	-	1	-	-		Plano HC-73225
	R703016	Esquema electrico de montaje		-	1	1	1	-	1	1		Plano HC-73224
	R693089	Instalacion electrica HMI		1	1	1	1	-	-	-		
	R693016	Instalacion electrica HMI (UL)		-	-	-	-	1	1	1		
	R693066	Cableado fuerza conveccion		1	-	-	-	-	-	-		
	R743062	Cableado fuerza conveccion (UL)		-	-	-	-	1	-	-		
	R143005	Cableado fuerza conveccion		-	1	1	1	-	-	-		
	R143015	Cableado fuerza conveccion (UL)		-	-	-	-	-	1	1		
	R693065	Instalacion fuerza cuadro electrico		1	-	-	-	-	-	-		
	R693073	Instalacion fuerza cuadro elec. (UL)		-	-	-	-	1	-	-		
	R703013	Instalacion fuerza cuadro electrico		-	1	1	1	-	-	-		
	R703025	Instalacion fuerza cuadro elec. (UL)		-	-	-	-	-	1	1		
	R663095	Cableado luz interior		1	1	1	1	1	1	1		
	R663094	Cableado luz puerta		1	1	1	1	-	-	-		
	R693053	Cableado luz puerta (UL)		-	-	-	-	1	1	1		
	3713900	Funda roja-negra Ø6,4x500		1	1	1	1	1	1	1		En cableado puerta

3N~50/60Hz 380/415V

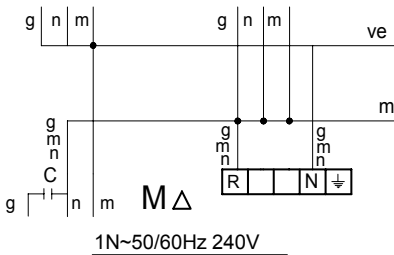
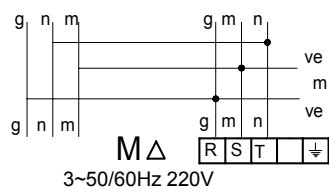
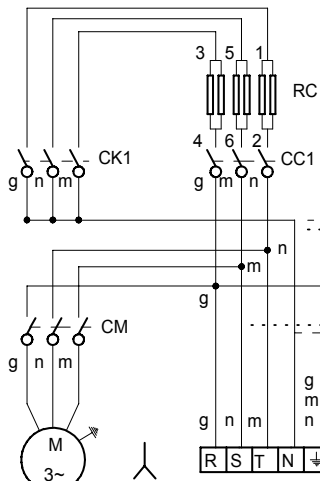

MODELO HMI-6/11

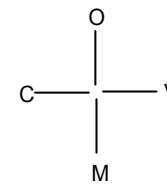
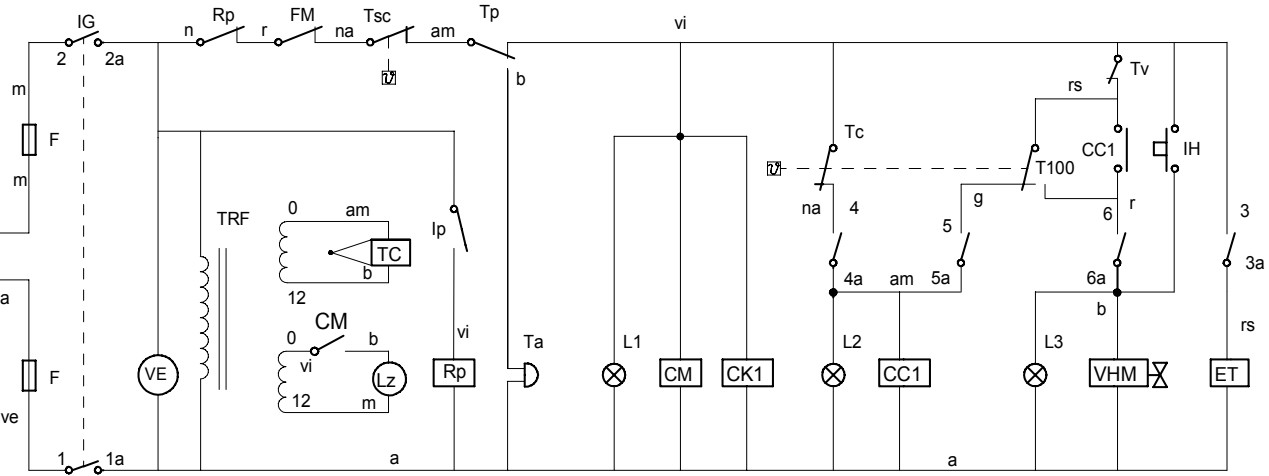

IG	1	2	3	4	5	6
o	1a	2a	3a	4a	5a	6a
VAPOR	×	×			×	×
MIXTO	×	×		×		×
CONVECCION	×	×	×	×		

av: amarillo-verde,yellow-green,jaune-vert
 am: amarillo,yellow,jaune
 a: azul,blue,bleu
 b: blanco,white,blanc
 g: gris,greys,gris
 ve: verde,green,vert

na: naranja,orange,orange
 r: rojo,red,rouge
 m: marron,brown,marron
 n: negro,black,noir
 rs: rosa,pink,rose
 vi: violeta,violet,violette

R-693069

T100: Termostato de 100°C
 Rc: Resistencia de calentamiento
 IG: Interruptor general
 Lz: Luz interior
 F: Fusible
 CM: Contactor motor
 VHM: Electrovalvula humidificador
 IP: Interruptor puerta
 FM: Térmico motor
 TP: Temporizador manual
 TSC: Termostato seguridad convección
 TV: Termostato vapor
 TRF: Transformador

M: Motor
 Tc: Termostato convección
 CK1, CC1: Contactor calentamiento
 ET: Electroimán de apertura de tiro
 C: Condensador
 L1: Lámpara marcha
 L2: Lámpara calentamiento
 L3: Lámpara humidificador
 Ta: Timbre avisador
 FI: Filtro de interferencias
 IH: Pulsador de humidificador
 VE: Ventilador cuadro eléctrico
 Rp: Relé puerta

		3~50/60Hz 220V		
		1N~50Hz 240V		
	ESQUEMA TEORICO ADHESIVO	3~50/60Hz 380/415V	R-693069	
Nº	Pieza	Material	Nº Clasificación	Acabado
Nº	Modificación	Propuesta de	Fecha	Tolerancias generales
1	Introducir Rp	Maillo	25/2/2002	<5± : 5-25± : 25-50± :
				50-100± : > 100± : ∞±
Dibujado	Firma	Fecha	Mecanizado superficial	
Proyectado	Irabxe	16/11/98		
Comprobado				
Escala				
Horno Inyección HMI-6/11			Plano numero HC-73226 -1	
Plano hau ez dateke erabili ez berrizta gure baimenitz gabe			Sustituye al Nº Sustituido por	

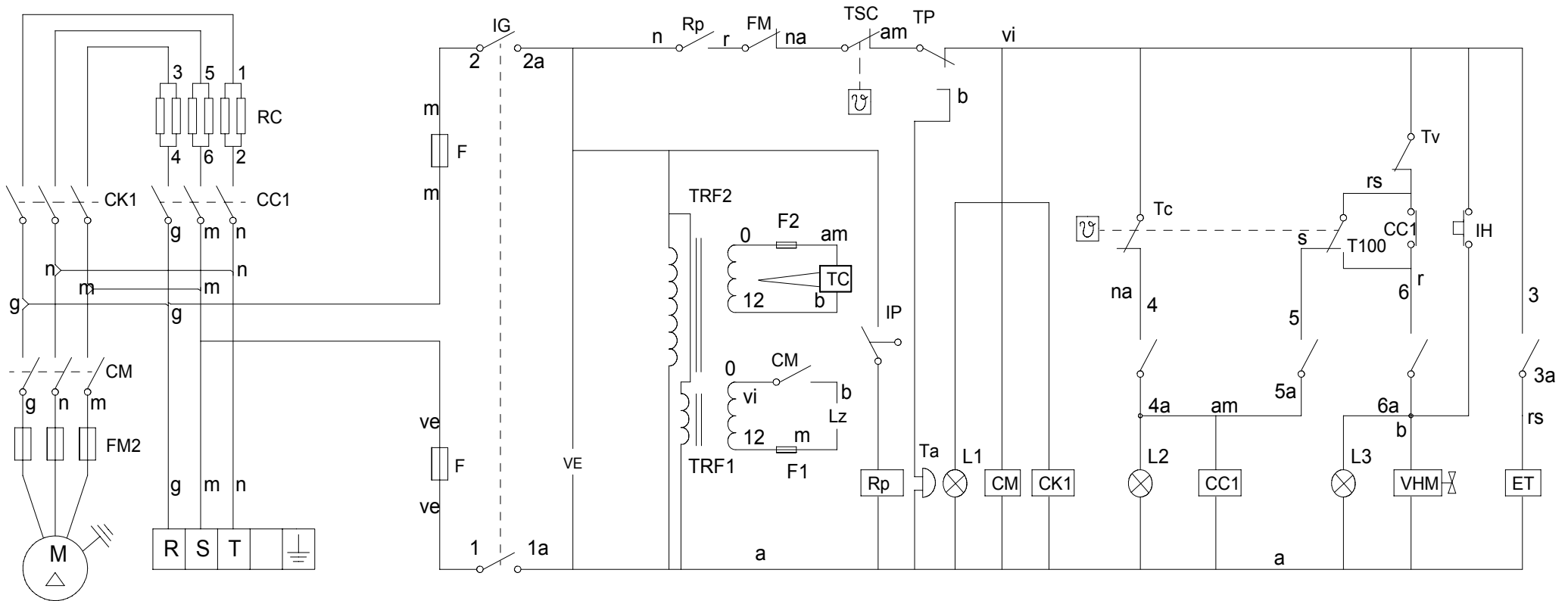

T100: 100 °C Thermostat

Rc= Heating element

IG= General switch

Lz= Indoor light

F= Fuse

CM= Motors relay

VHM= Humidify water solenoid

IP= Door's switch

FM= Motor's thermal protection

TP= Manual timer

TSC= Convection's security thermostat

TV= Steamer's thermostat

TRF2= Transformer (Electronic thermostat)

TRF1= Transformer (Indoor light)

Rp = Door's relay

M = Motor

Tc = Convection thermostat

CC, CC1 = Heating relays

ET = Chimney solenoid

L1 = Pilot lamp (on/off)

L2 = Pilot lamp (Heating)

L3 = Pilot lamp (Water)

Ta = Alarm

IH = Humidity switch

VE = Control panel's fan

F1, F2 = Transformer fuse

FM2 = Motor fuse

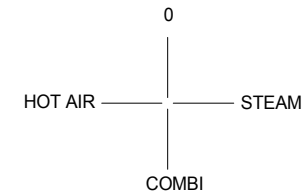

am/ve = amarillo/verde-yellow/green-jaune/vert

am = amarillo-yellow-jaune

a = azul-blue-bleu

b = blanco-white-blanc

g = gris-grey -gris

ve = verde-green-vert

IG	1	2	3	4	5	6
	1a	2a	3a	4a-5a	6a	
0						
STEAM	X	X			X	X
COMBI	X	X		X		X
HOT AIR	X	X	X	X		

na = naranja-orange-orange

r = rojo-red-rouge

m = marron-brown-marron

n = negro-black-noir

rs = rosa-pink-rose

vi = violeta-violet-violette

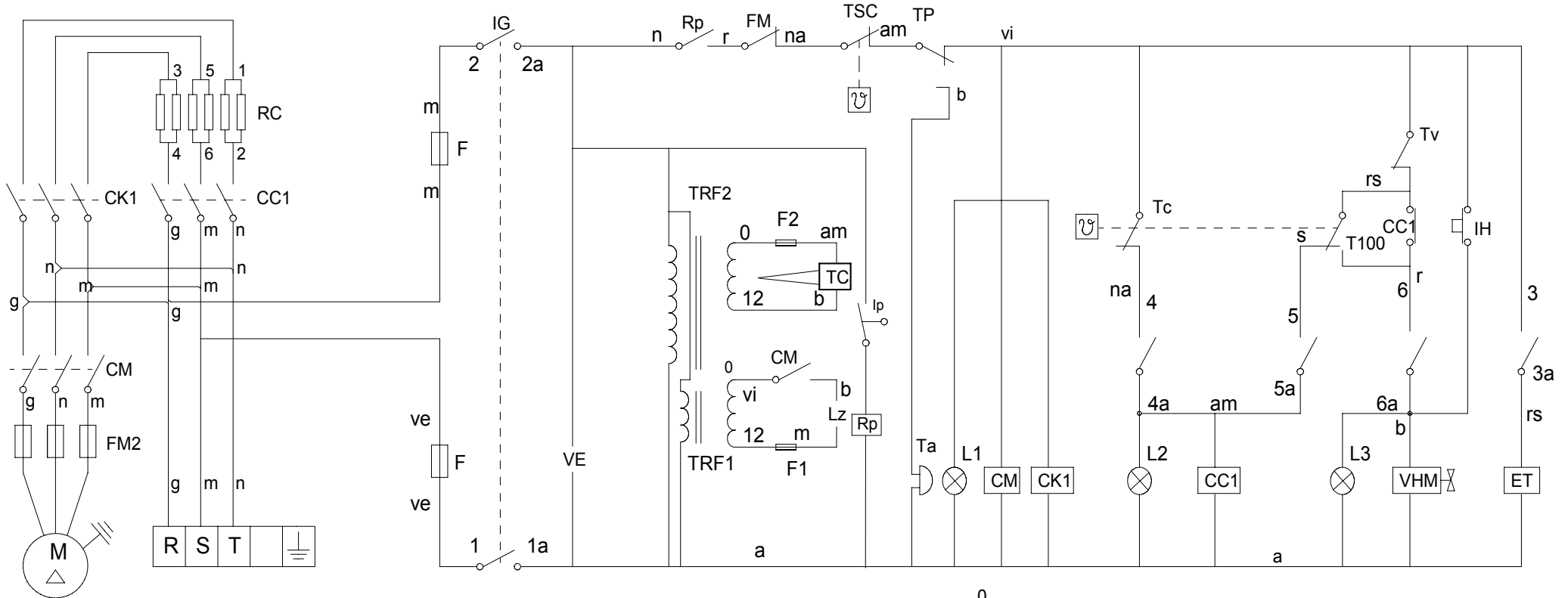

T100: 100 °C Thermostat

Rc= Heating element

IG= General switch

Lz= Indoor light

F= Fuse

CM= Motors relay

VHM= Humidify water solenoid

IP= Door's switch

FM= Motor's thermal protection

TP= Manual timer

TSC= Convection's security thermostat

TV= Steamer's thermostat

TRF2= Transformer (Electronic thermostat)

TRF1= Transformer (Indoor light)

Rp = Door's Relay

M = Motor

Tc = Convection thermostat

CC, CC1 = Heating relays

ET = Chimney solenoid

L1 = Pilot lamp (on/off)

L2 = Pilot lamp (Heating)

L3 = Pilot lamp (Water)

Ta = Alarm

IH = Humidity switch

VE = Control panel's fan

F1, F2 = Transformer fuse

FM2 = Motor fuse

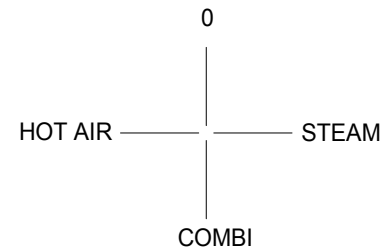

am/ve = amarillo/verde-yellow/green-jaune/vert

am = amarillo-yellow-jaune

a = azul-blue-bleu

b = blanco-white-blanc

g = gris-grey -gris

ve = verde-green-vert

na = naranja-orange-orange

r = rojo-red-rouge

m = marron-brown-marron

n = negro-black-noir

rs = rosa-pink-rose

vi = violeta-violet-violette

IG	1 1a	2 2a	3 3a	4 4a - 5a	5 6a	6
0						
STEAM	X	X			X	X
COMBI	X	X		X		X
HOT AIR	X	X	X	X		

MODELO HMI-10/11 HMI-10/21

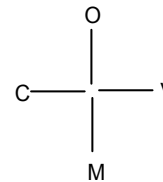
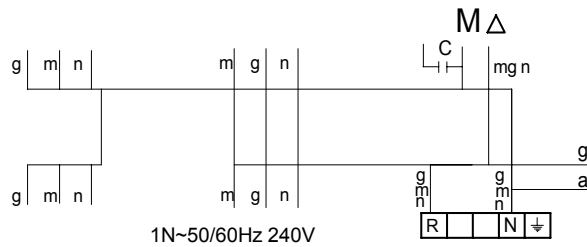
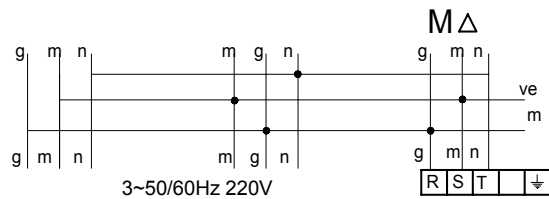
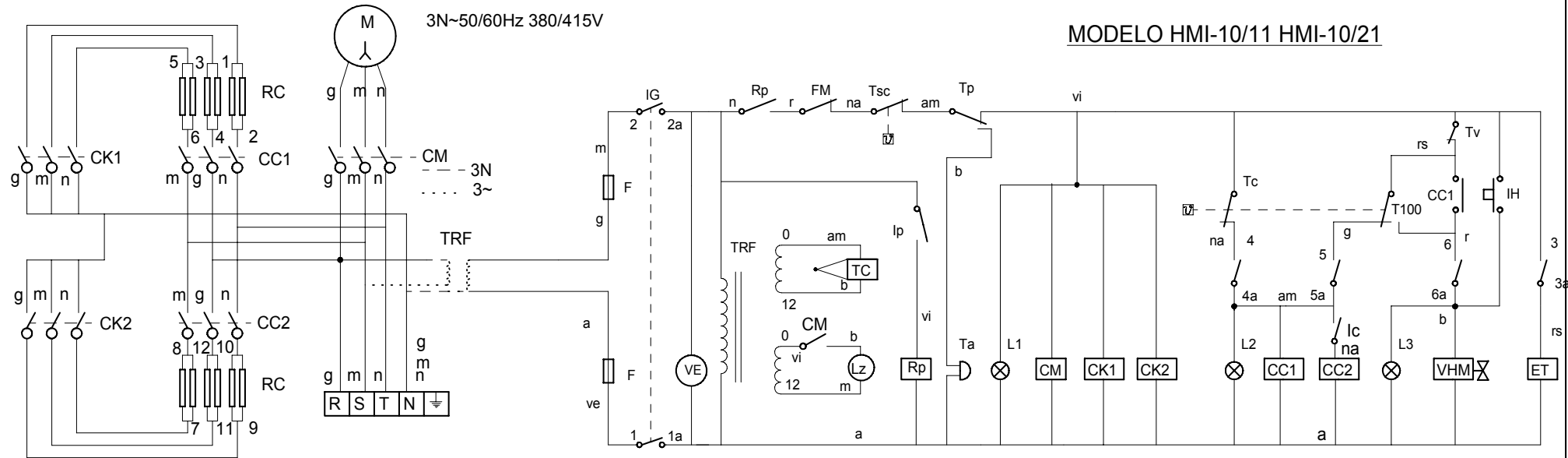

IG	1	2	3	4	5	6
	1a	2a	3a	4a	5a	6a
VAPOR	X	X			X	X
MIXTO	X	X		X		X
CONVECCION	X	X	X	X		

av: amarillo-verde, yellow-green, jaune-vert
 am: amarillo, yellow, jaune
 a: azul, blue, bleu
 b: blanco, white, blanc
 g: gris, grey, gris
 ve: verde, green, vert

na: naranja, orange, orange
 r: rojo, red, rouge
 m: marron, brown, marron
 n: negro, black, noir
 rs: rosa, pink, rose
 vi: violeta, violet, violette

- T100: Termostato de 100°C
- Rc: Resistencia de calentamiento
- IG: Interruptor general
- Lz: Luz interior
- F: Fusible
- CM: Contactor motor
- VHM: Electrovalvula humidificador
- IP: Interruptor puerta
- FM: Térmico motor
- TP: Temporizador manual
- TSC: Termostato seguridad convección
- TV: Termostato vapor
- TRF: Transformador
- M: Motor
- Tc: Termostato convección
- CK1, CC1: Contactor calentamiento
- ET: Electroimán de apertura de tiro
- C: Condensador
- L1: Lámpara marcha
- L2: Lámpara calentamiento
- L3: Lámpara humidificador
- Ta: Timbre avisador
- FI: Filtro de interferencias
- IH: Pulsador de humidificador
- VE: Ventilador cuadro eléctrico
- Rp: Relé puerta

R-703015

		3~50/60Hz 220V		
		1N~50Hz 240V		
		3~50/60Hz 380/415V	R-703015	
Nº	Pieza	Material	Nº Clasificación	Acabado
Nº	Modificación	Propuesta de	Fecha	Tolerancias generales
1	Introducir RP	Maillo	25/2/2002	<5± : 50-100± : 5-25± : > 100± 25-50± : <X±
		Firma	Fecha	Mecanizado superficial
		Iraxte	13/11/98	
		Fagor Industrial, Koop, Elk, Mugatua		
		Plano numero		
		<p align="center">HORNO INYECCION HMI-10/11 HMI-10/21</p>		
		<p align="center">HC-73227 -1</p>		
		Sustituye al Nº		
		Sustituido por		

Plano hau ez dateke erabili ez berrizta gure baimenitz gabe

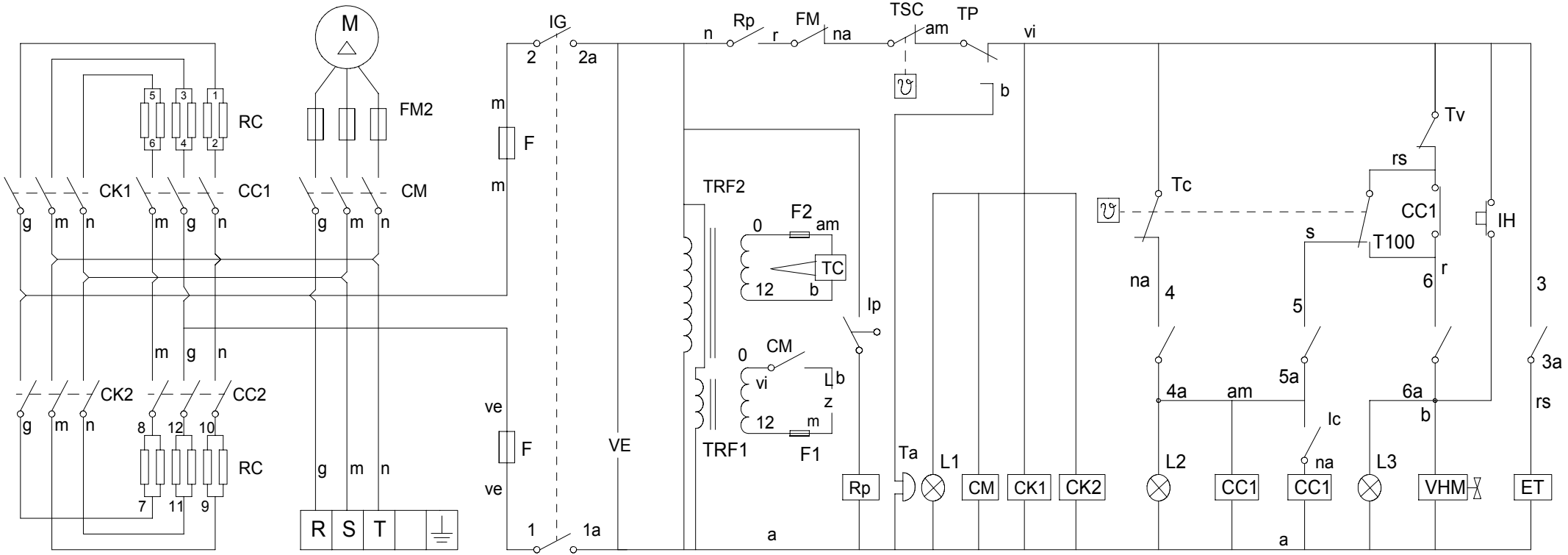

T100= 100 °C Thermostat

Rc= Heating element

IG= General switch

Lz= Indoor light

F= Fuse

CM= Motors relay

VHM= Humidify water solenoid

IP= Door's switch

FM= Motor's thermal protection

TP= Manual timer

TSC= Convection's security thermostat

TV= Steamer's thermostat

TRF2= Transformer (Electronic thermostat)

TRF1= Transformer (Indoor light)

FM2 = Motor fuse

Rp = Door's Relay

M = Motor

Tc = Convection thermostat

CC, CC1, CC2 = Heating relays

ET = Chimney solenoid

L1 = Pilot lamp (on/off)

L2 = Pilot lamp (Heating)

L3 = Pilot lamp (Water)

Ta = Alarm

IH = Humidity switch

IC = Power reduction switch

VE = Control panel's fan

F1, F2 = Transformer fuse

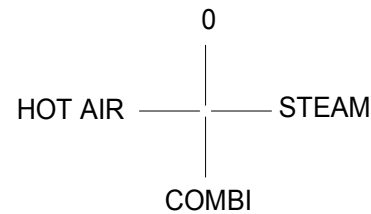

IG	1 1a	2 2a	3 3a	4 4a-5a	6 6a
0					
STEAM	X	X		X	X
COMBI	X	X		X	X
HOT AIR	X	X	X	X	

am/ve = amarillo/verde-yellow/green-jaune/vert

am = amarillo-yellow-jaune

a = azul-blue-bleu

b = blanco-white-blanc

g = gris-grey -gris

ve = verde-green-vert

na = naranja-orange-orange

r = rojo-red-rouge

m = marron-brown-marron

n = negro-black-noir

rs = rosa-pink-rose

vi = violeta-violet-violette

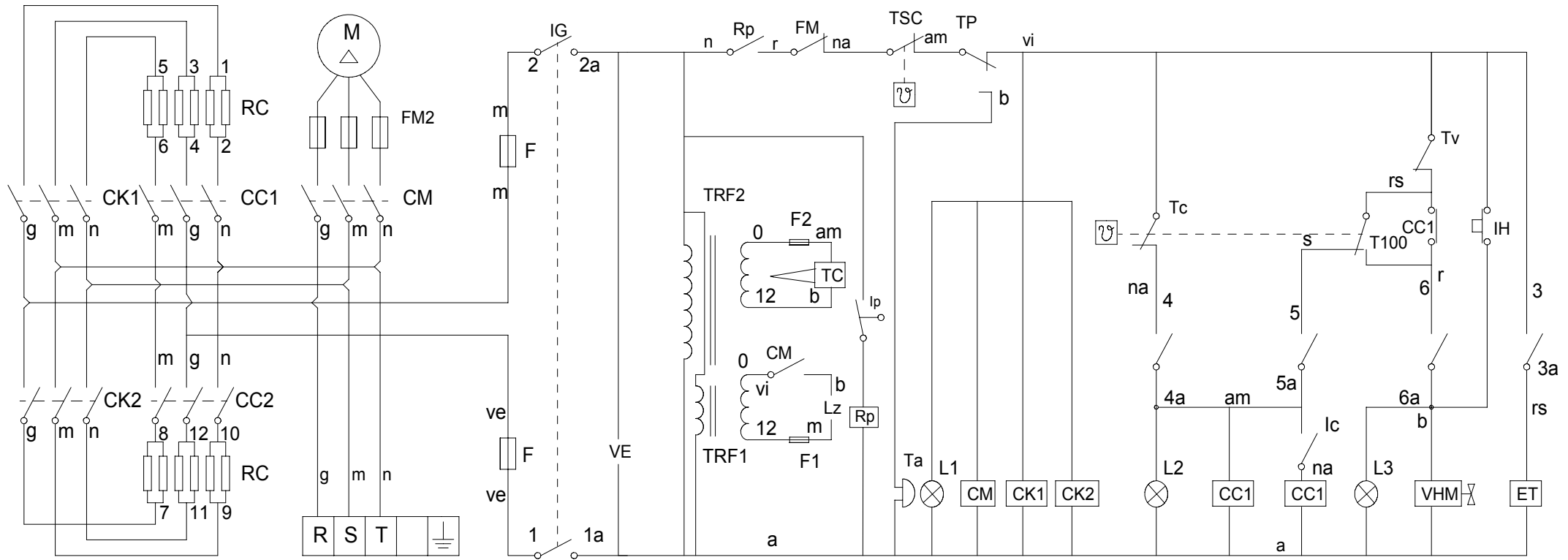

T100= 100 °C Thermostat

Rc= Heating element

IG= General switch

Lz= Indoor light

F= Fuse

CM= Motors relay

VHM= Humidify water solenoid

IP= Door's switch

FM= Motor's thermal protection

TP= Manual timer

TSC= Convection's security thermostat

TV= Steamer's thermostat

TRF2= Transformer (Electronic thermostat)

TRF1= Transformer (Indoor light)

Rp = Door's Realy

FM2 = Motor fuse

M = Motor

Tc = Convection thermostat

CC, CC1, CC2 = Heating relays

ET = Chimney solenoid

L1 = Pilot lamp (on/off)

L2 = Pilot lamp (Heating)

L3 = Pilot lamp (Water)

Ta = Alarm

IH = Humidity switch

IC = Power reduction switch

VE = Control panel's fan

F1, F2 = Transformer fuse

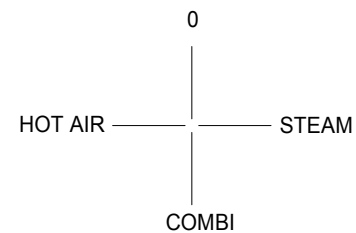

am/ve = amarillo/verde-yellow/green-jaune/vert

am = amarillo-yellow-jaune

a = azul-blue-bleu

b = blanco-white-blanc

g = gris-grey -gris

ve = verde-green-vert

IG	1 1a	2 2a	3 3a	4 4a-5a	6 6a
0					
STEAM	X	X		X	X
COMBI	X	X		X	X
HOT AIR	X	X	X	X	

na = naranja-orange-orange

r = rojo-red-rouge

m = marron-brown-marron

n = negro-black-noir

rs = rosa-pink-rose

vi = violeta-violet-violette

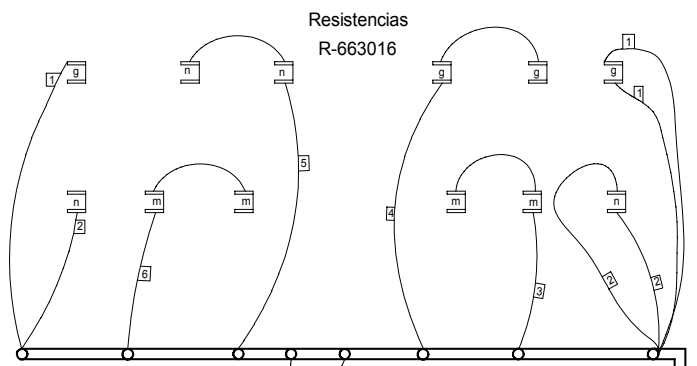

Resistencias
R-663016

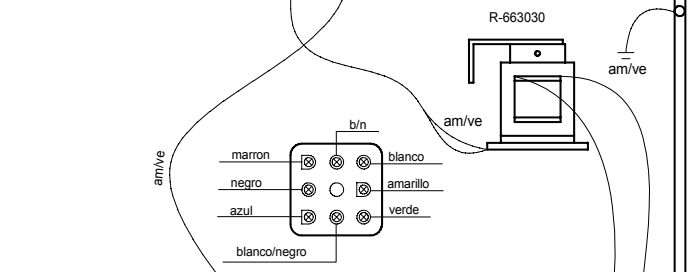

Motor
R-693043

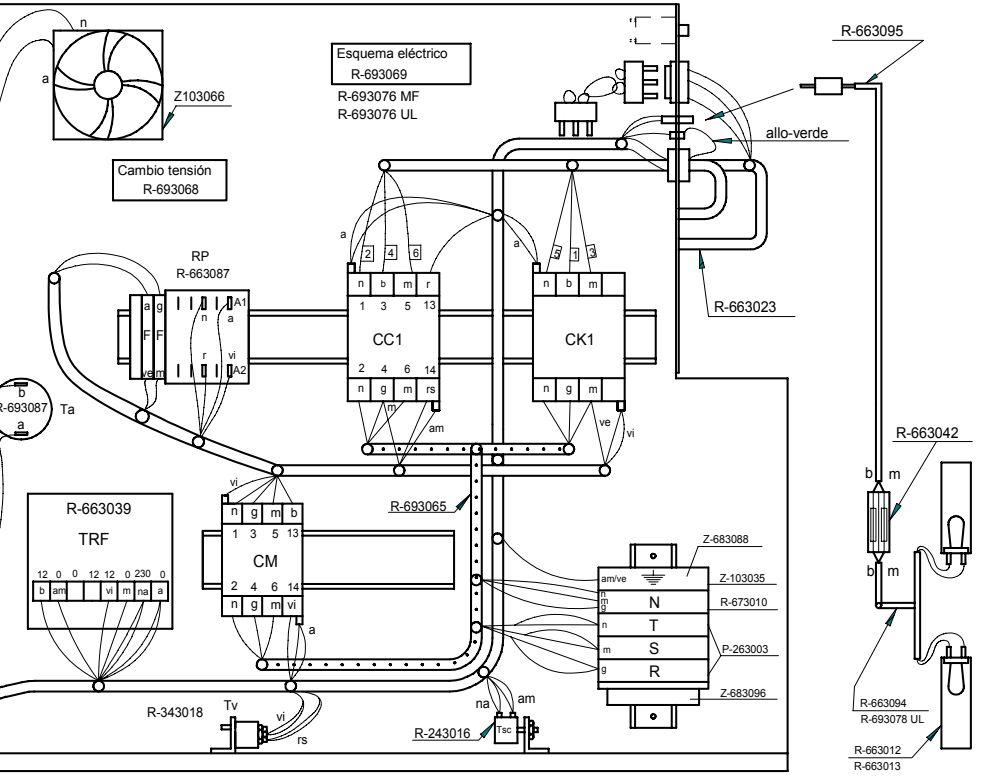
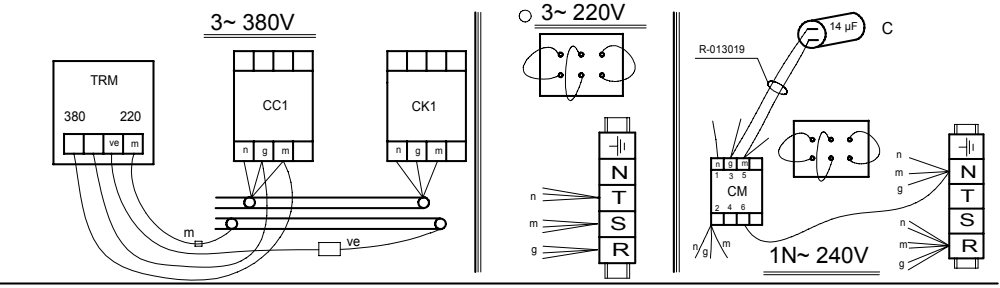
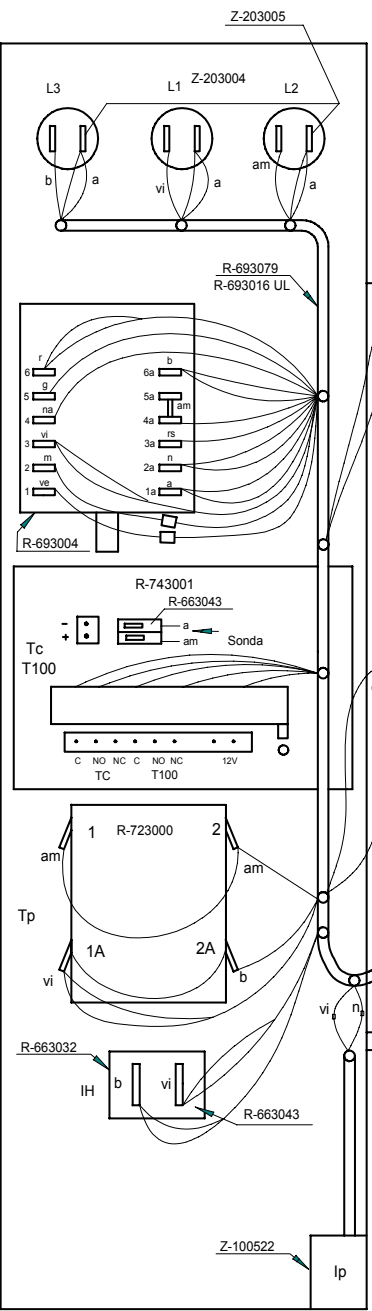
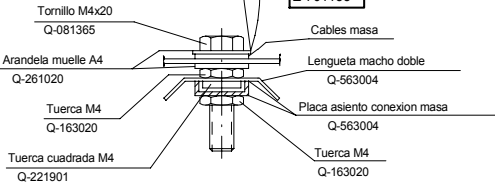
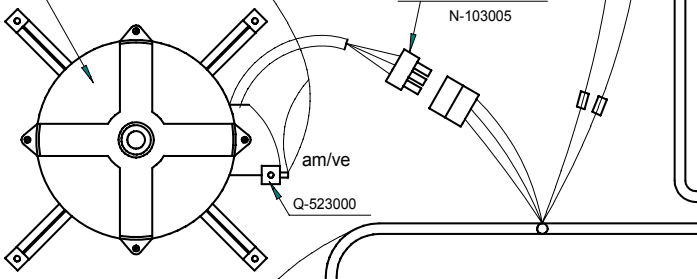

Esquema de montaje 3N 380V		R-693070	
Nº Pieza	Cant.	Material	Nº Clasificación
1	Introducir RP	Maillo	26/2/2002
Nº Modificación		Propuesta de	Fecha
1		Maillo	26/2/2002
		Tolerancias generales	
		< 5 ±	50-100 ±
		5-25 ±	> 100 ±
		25-50 ±	∞ ±
Dibujado		Firma	Fecha
Proyectado		KONTXI	8/4/98
Comprobado		FAGOR	
Escala		Fagor Industrial, Koop, Elk, Mugatua	
		Mecanizado superficial	
		Plano numero	
		HC-73225 -1	
		Sustituye al Nº	
		Sustituido por	

Plano hau ez dateke erabili ez berritza gure baimenitz gabe

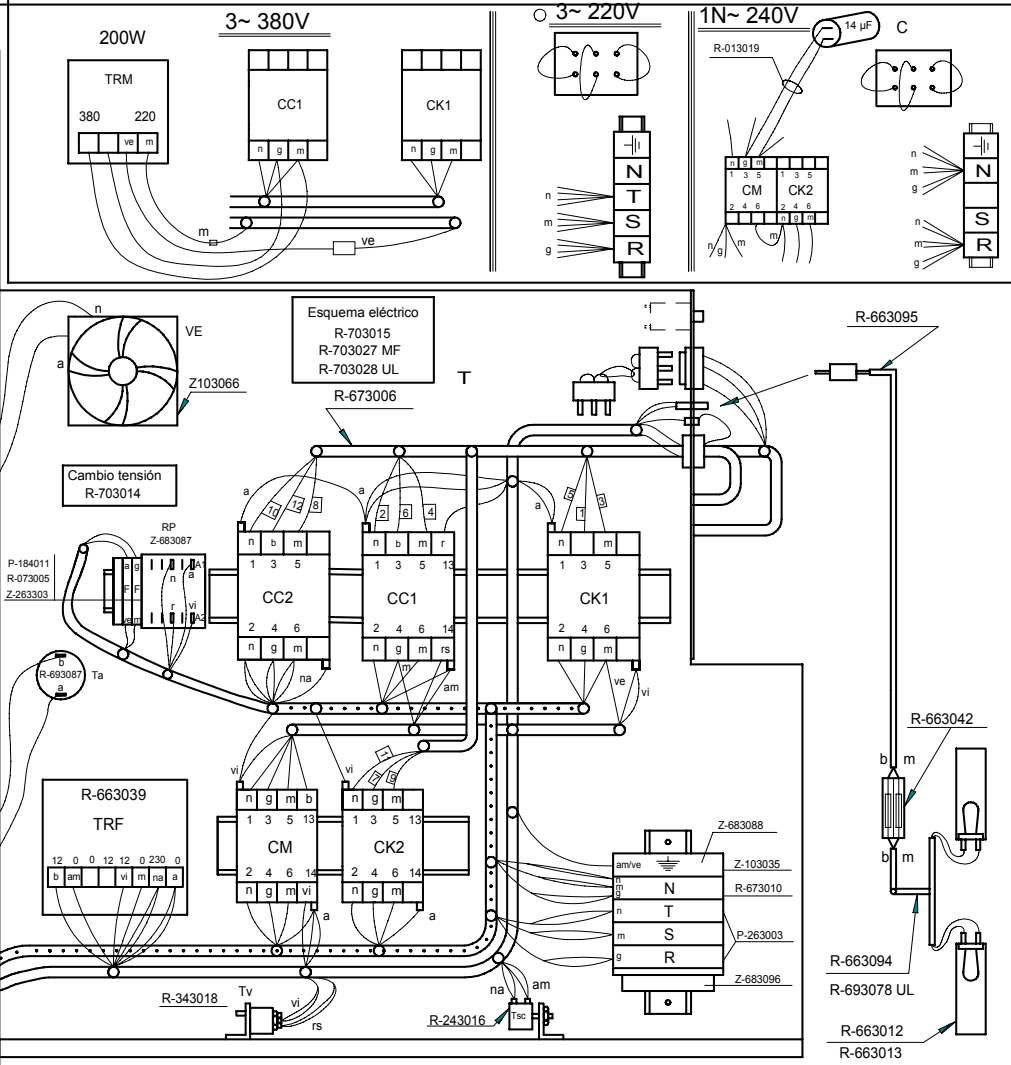
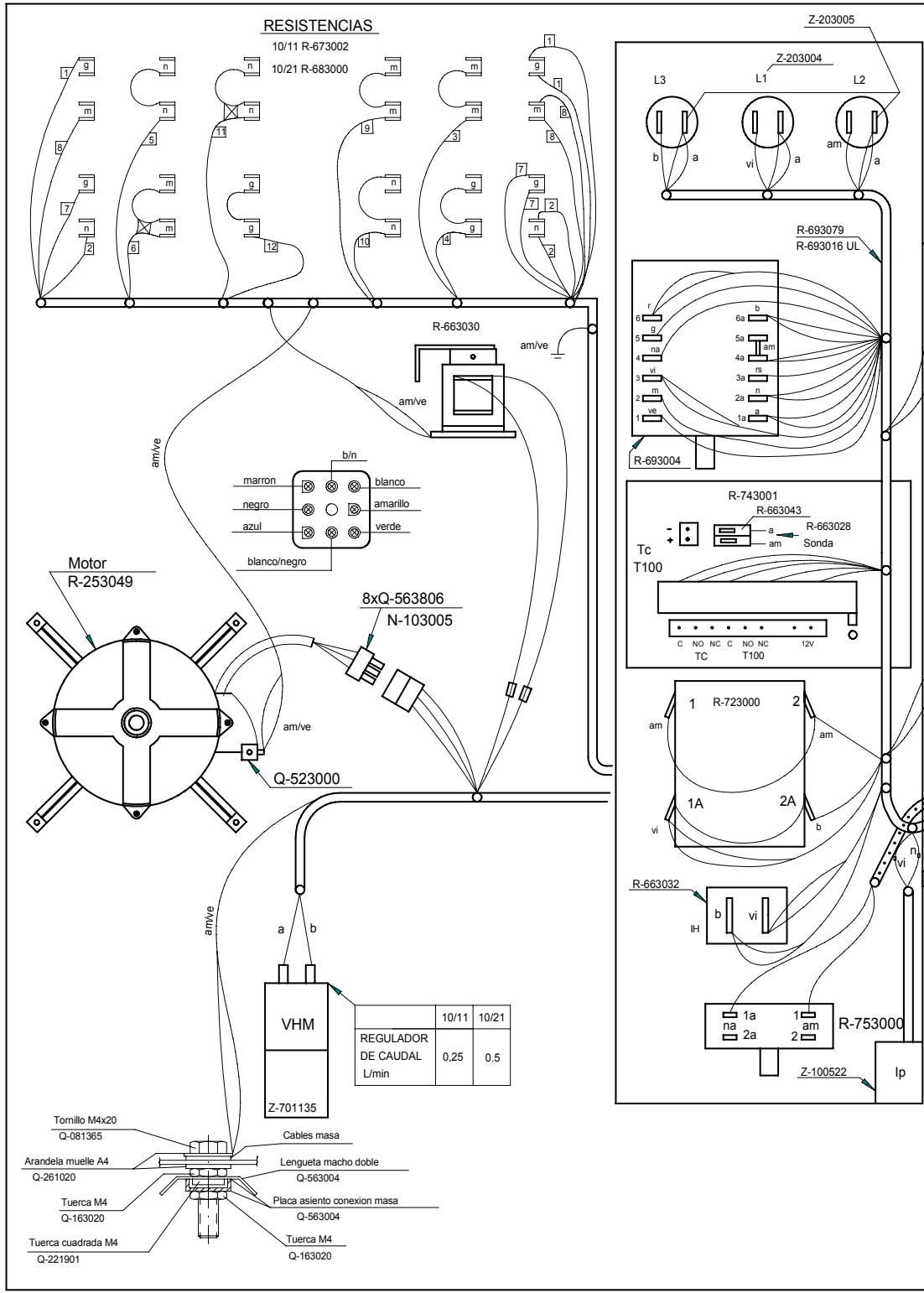

Esquema de montaje 3N 380V			R-703016		
Nº	Pieza	Cant.	Material	Nº Clasificación	Acabado
Nº	Modificación	Propuesta de		Fecha	Tolerancias generales
1	Introducir Rp	Maillo		26/2/2002	$5\pm$ 5-25± : > 100± 25-50± : $\infty\pm$
Firma			Fecha	Mecanizado superficial	
Dibujado			KONTXI	8/4/98	FAGOR Fagor Industrial, Koop, Elk, Mugatua
Proyectado					
Comprobado					
Escala			Plano numero		
			HC-73224 -1		
			Sustituye al Nº		
			Sustituido por		

HORNO HMI-10/11 INYECCION

Plano hau ez dateke erabili ez bermiza gure baimenitz gabe