

# RIVER 80

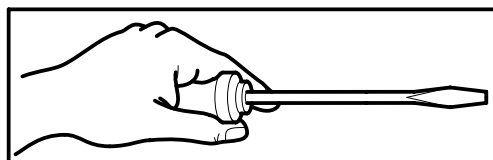

Tav. 1 – Carrozzeria  
Tav. 2 – Impianto elettrico  
Tav. 3 – Componenti in vasca  
Tav. 4 – Lance lavaggio – Risciacquo  
Tav. 5 – Pompa lavaggio

Tav. 1 – Machine Body  
Tav. 2 – Electrical components  
Tav. 3 – Components in the tank  
Tav. 4 – Wash arms – Rinsing  
Tav. 5 – Wash pump

Tab. 1 – Carrocera  
Tab. 2 – Instalaciòn elèctrica  
Tab. 3 – Componentes en cuba  
Tab. 4 – Lances lavages – Enjuague  
Tab. 5 – Bomba lavado

Tab. 1 – Carrosserie  
Tab. 2 – Installation électrique  
Tab. 3 – Composants de cuve  
Tab. 4 – Rampes de lavage Rinçage  
Tab. 5 – Pompe lavage

Taf. 1 – Verkleidung  
Taf. 2 – Elektrische Anlage  
Taf. 3 – Bauteile im Waschtank  
Taf. 4 – Spuelarme – Klarspülung  
Taf. 5 – Spülpumpe

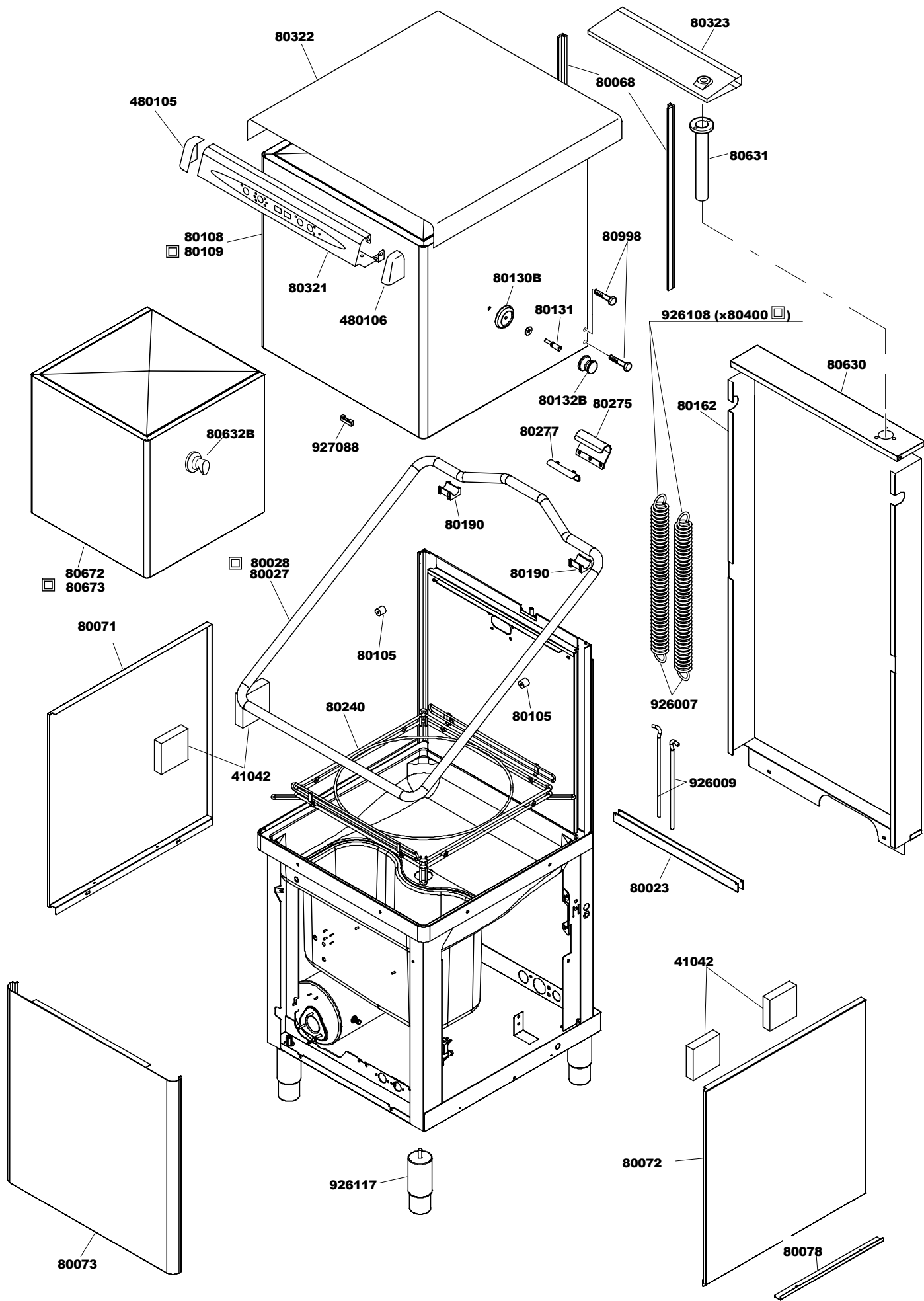

☐ ( Coibentazione; Insulation)

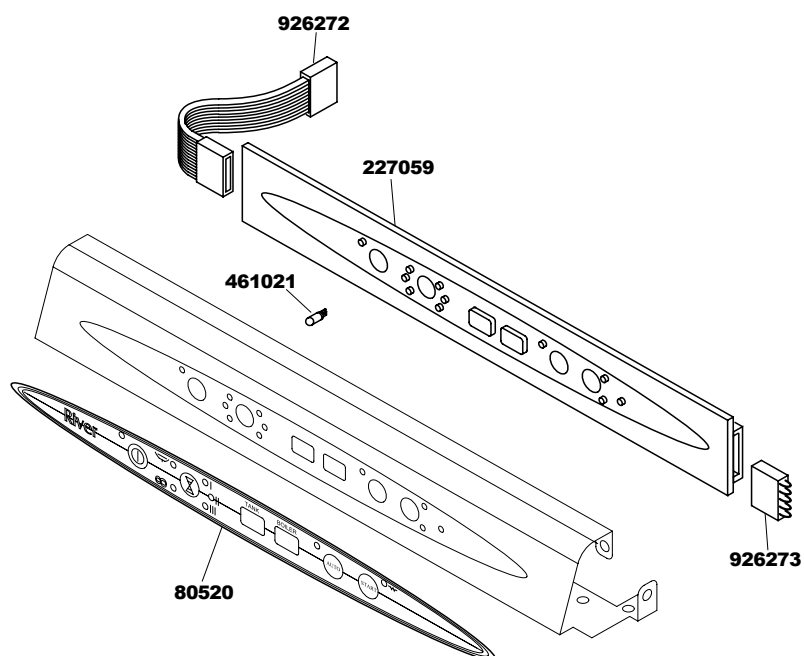
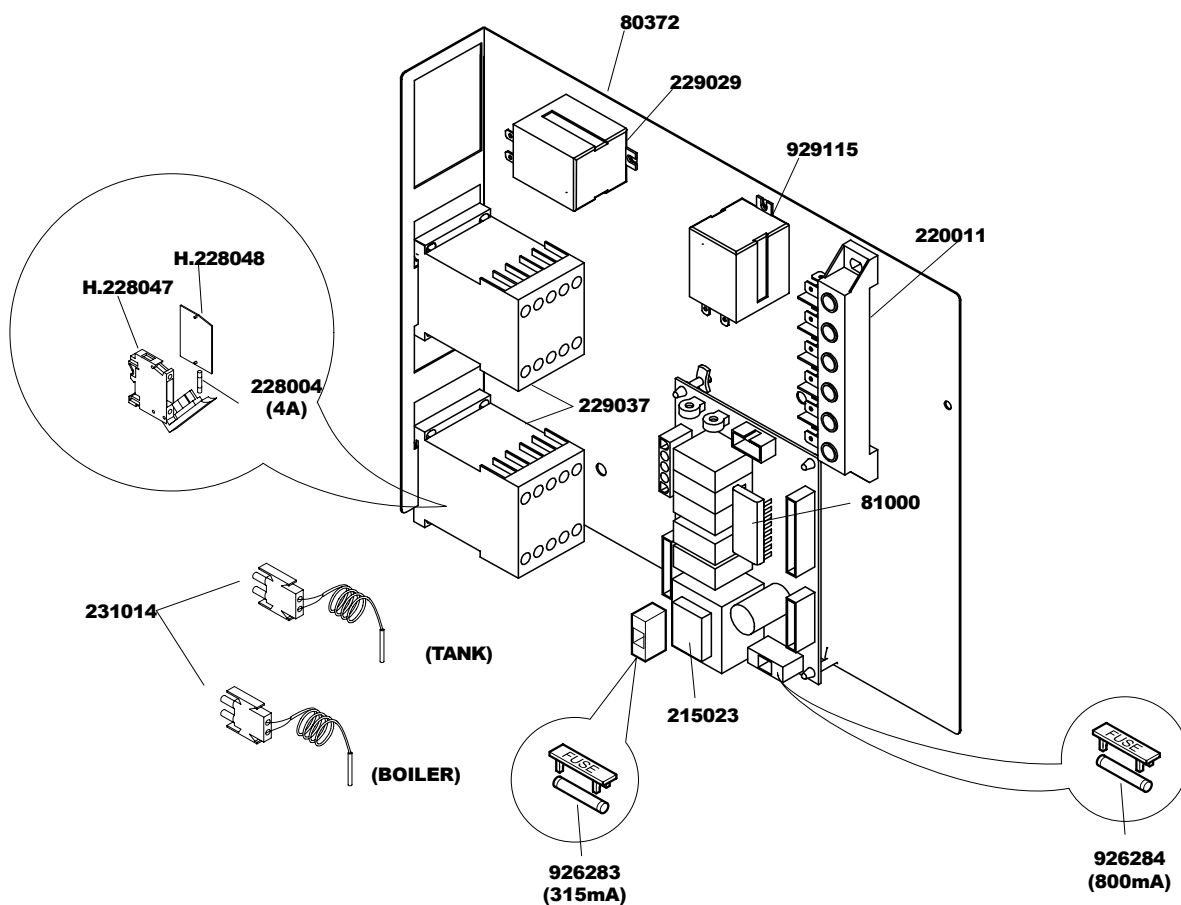

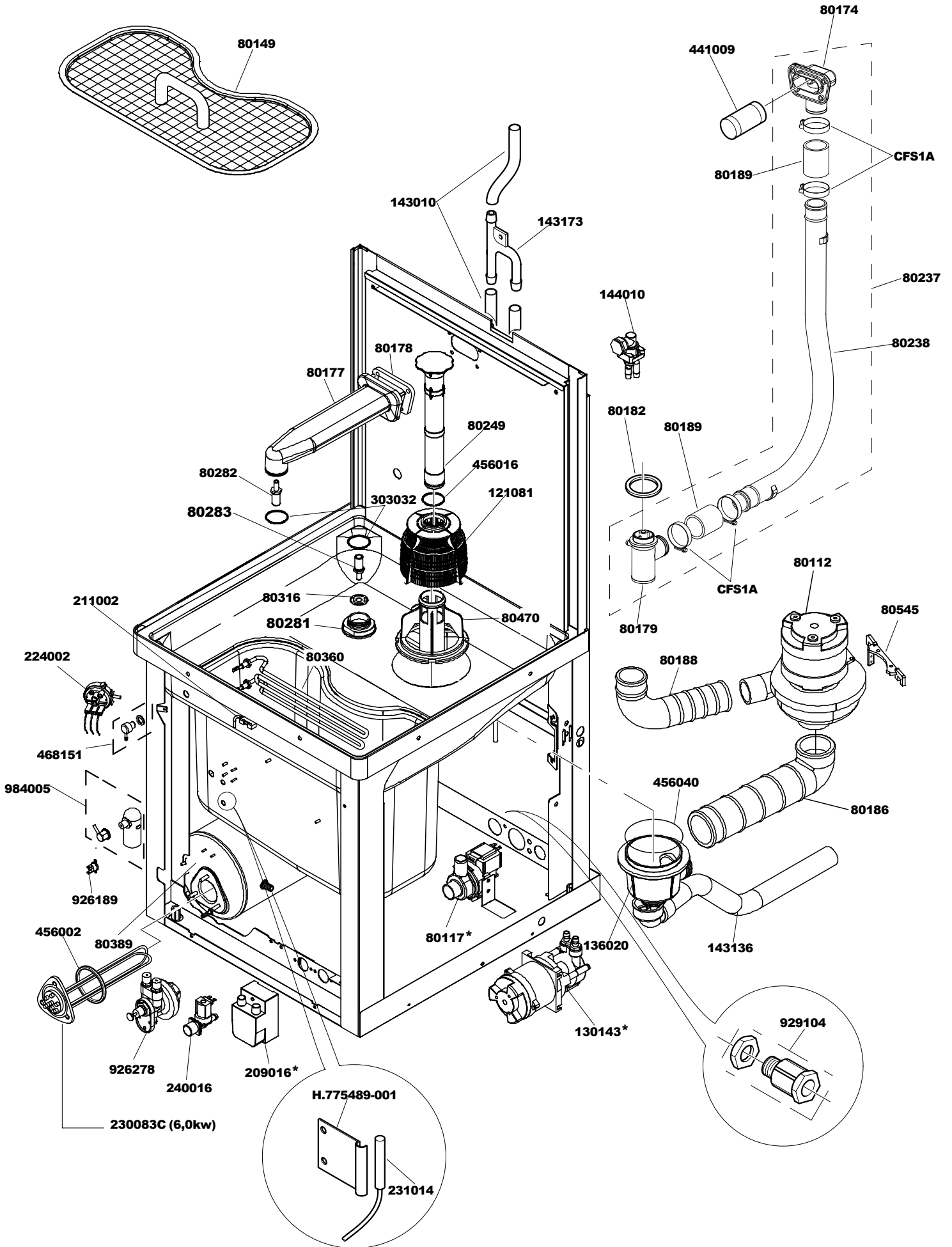

(\*) Optional

