



**GASTROPARTS**

# Ubert

- [EN]** Equipment
- [DE]** Geräte
- [ES]** Aparatos
- [FR]** Équipement
- [IT]** Attrezzature
- [PL]** Urządzenia
- [RU]** Оборудование

✉ [gastroparts@gastroparts.com](mailto:gastroparts@gastroparts.com)

☎ +48 56 657 00 66

📘 [fb.com/gastroparts.global](https://fb.com/gastroparts.global)

**GASTROPARTS.COM**











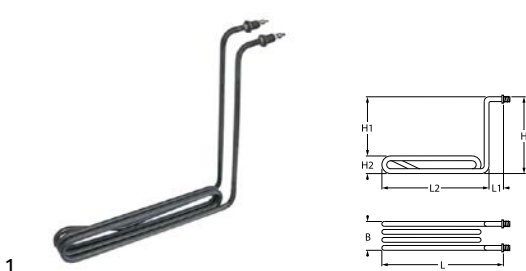

## heating elements

### heating elements for bain maries

			
<b>Part No.</b>	415567	<b>Ref. No.</b>	343102
<b>description</b>	heating element 2000W 230V heating circuits 1 L 425mm W 145mm connection M4 tube ø 8.5mm 2 hole fixing thread M14x1.5 dry heating element L1 30mm L2 115mm W1 92mm W2 56mm mounting distance 48mm		

### heating elements for fryers

#### 2 hole fixing

			
<b>Part No.</b>	415566	<b>Ref. No.</b>	343104 MS0100E
<b>description</b>	heating element 2000W 230V heating circuits 1 L 325mm W 42mm H 275mm L1 35mm L2 290mm H1 235mm H2 40mm thread M12x1 mounting distance 31mm tube ø 8.5mm 2 hole fixing connection M4 fryer heaters windings 3		
<b>spare parts for</b>	415566		
	<b>Part No.</b>	521110	<b>Ref. No.</b> —
	flat gasket fibre ED ø 20mm ID ø 13mm thickness 2mm Qty 1 pcs		
<b>accessories for</b>	415566		
	<b>Part No.</b>	520229	<b>Ref. No.</b> —
	nut thread M12x1 H 4mm WS 16 zinc-coated steel Qty 1 pcs		
	<b>Part No.</b>	521103	<b>Ref. No.</b> —
	nut thread M4 H 3mm WS 7 brass Qty 20 pcs		
	<b>Part No.</b>	521104	<b>Ref. No.</b> —
	washer ID ø 4.3mm ED ø 8mm thickness 0.5mm brass Qty 20 pcs for thread M4		
	<b>Part No.</b>	521131	<b>Ref. No.</b> —
	nut thread M12x1 H 3.5mm WS 17 SS Qty 1 pcs		
	<b>Part No.</b>	528110	<b>Ref. No.</b> —
	O-ring EPDM thickness 2.62mm ID ø 12.37mm Qty 1 pcs		
	<b>Part No.</b>	560111	<b>Ref. No.</b> —
	plain washer ID ø 4.3mm ED ø 9mm thickness 0.8mm SS Qty 20 pcs DIN 125A for thread M4		
	<b>Part No.</b>	560131	<b>Ref. No.</b> —
	hexagonal nut thread M4 H 3.2mm WS 7 SS DIN/ISO DIN 934 / ISO 4032/8673 Qty 20 pcs		

### heating elements for griddles







			
<b>Part No.</b>	415561	<b>Ref. No.</b>	343103
<b>description</b>	heating element 2000W 230V L 426mm W 150mm Hmm tube ø 8.5mm L1 22mm L2 388.5mm W1 112mm W2 38mm 2 hole fixing connection male faston 6.3mm thread M14x1.25 mounting distance 30mm immersion heater		
<b>spare parts for</b>	415561		
	<b>Part No.</b>	510417	<b>Ref. No.</b> —
	flat gasket fibre ED ø 20mm ID ø 14mm thickness 2mm Qty 1 pcs		
<b>accessories for</b>	415561		
	<b>Part No.</b>	361182	<b>Ref. No.</b> —
	nut thread 1/4" H 5mm nickel-plated brass WS 17 Qty 1 pcs		
	<b>Part No.</b>	510420	<b>Ref. No.</b> —
	gasket copper ED ø 19.9mm ID ø 14.3mm thickness 2mm Qty 1 pcs		
	<b>Part No.</b>	520228	<b>Ref. No.</b> —
	tooth lock washer ID ø 15.3mm ED ø 24mm steel Qty 1 pcs for thread M14		
	<b>Part No.</b>	521103	<b>Ref. No.</b> —
	nut thread M4 H 3mm WS 7 brass Qty 20 pcs		
	<b>Part No.</b>	521104	<b>Ref. No.</b> —
	washer ID ø 4.3mm ED ø 8mm thickness 0.5mm brass Qty 20 pcs for thread M4		
	<b>Part No.</b>	560111	<b>Ref. No.</b> —
	plain washer ID ø 4.3mm ED ø 9mm thickness 0.8mm SS Qty 20 pcs DIN 125A for thread M4		
	<b>Part No.</b>	560131	<b>Ref. No.</b> —
	hexagonal nut thread M4 H 3.2mm WS 7 SS DIN/ISO DIN 934 / ISO 4032/8673 Qty 20 pcs		
			
<b>Part No.</b>	416964	<b>Ref. No.</b>	343126 343126 rechte
<b>description</b>	heating element 2200W 240V heating circuits 1 L 365mm W 174mm H 30mm tube ø 8.5mm W1 86mm W2 88mm 2 hole fixing connection male faston 6.3mm thread M14x1.5 mounting distance 82mm for griddle dry heating element		
<b>spare parts for</b>	416964		
	<b>Part No.</b>	510417	<b>Ref. No.</b> —
	flat gasket fibre ED ø 20mm ID ø 14mm thickness 2mm Qty 1 pcs		
<b>accessories for</b>	416964		
	<b>Part No.</b>	520228	<b>Ref. No.</b> —
	tooth lock washer ID ø 15.3mm ED ø 24mm steel Qty 1 pcs for thread M14		
	<b>Part No.</b>	520230	<b>Ref. No.</b> —
	nut thread M14x1.5 H 5mm WS 19 zinc-coated steel Qty 1 pcs		

Table continues overleaf





accessories for	416964			
	Part No.	521101	Ref. No.	—
	nut thread M14x1.5 H 5mm WS 19 SS Qty 1 pcs			
	Part No.	550262	Ref. No.	—
	flat gasket copper ED ø 20mm ID ø 14mm thickness 2mm			

## heating elements for chicken rotisseries

	1		
Part No.	419173	Ref. No.	343113
description	heating element 4500W 235V rectangular flange L 205mm W 195mm H 48mm heating circuits 1 connection M4 L1 72mm L2 135mm dry heating element tube ø 8.5mm flange length 70mm flange width 22mm connection length 50mm chicken rotisserie		

## heating elements for chargrills

	1		
Part No.	415564	Ref. No.	343161
description	heating element 1100W 230V heating circuits 1 L 471mm W 82mm rectangular flange hole distance 42.2mm hole ø 5.5mm cable length 1200mm flange length 98mm flange width 24mm tube ø 13x5mm dry heating element connection length 25mm		

	1		
Part No.	416913	Ref. No.	343131
description	heating element 5200W 230V heating circuits 4 L 437mm W 120mm rectangular flange hole distance 48mm hole ø M4mm connection M4 flange length 125mm flange width 26mm tube ø 8.5mm dry heating element H 8.5mm		

## hot plates

### round

### with radiused edge

### for domestic and commercial kitchens

	1		
Part No.	490018	Ref. No.	343203
description	hot plate ø 220mm 2000W 230V connection 4 screw clamps with 8mm spill ring		

## energy regulators

### EGO

#### 1-circuit

	1		
Part No.	380015	Ref. No.	341141
description	energy regulator 230V 13A single-circuit turn direction right shaft ø 6x4.6mm shaft L 23mm mounting thread M4 power release 6-100% no. 50.57021.010		

## thermostats

### control and safety thermostats

### EGO

#### control thermostats

#### 55.13\_ series

	1			
Part No.	375012	Ref. No.	342229	
description	thermostat t.max. 358°C temperature range 50-358°C 1-pole 1NO 16A probe ø 3.1mm probe L 147mm capillary pipe 1730mm capillary pipe isolated 1100mm gland nut shaft L 23mm shaft position upper rotation 270°			
accessories for	375012			
	Part No.	110247	Ref. No.	—
	knob thermostat t.max. 350°C ø 50mm shaft ø 6x4.6mm shaft flat upper black temperature range 100-350°C			

#### 55.34\_ series

	1		
Part No.	375022	Ref. No.	342206
description	thermostat t.max. 180°C temperature range 95-180°C 3-pole 3NO 16A probe ø 6mm probe L 133mm capillary pipe 1780mm capillary pipe isolated 1400mm gland nut M9x1 shaft ø 6x4.6mm shaft L 23mm rotation 270°		



**E-G-O**



1

<b>Part No.</b>	375019	<b>Ref. No.</b>	342217
<b>description</b>	thermostat t.max. 85°C temperature range 30-85°C 3-pole 3NO 16A probe ø 6mm probe L 131mm capillary pipe 1440mm capillary pipe isolatedmm gland nut M9x1 shaft ø 6x4.6mm shaft L 23mm shaft position upper rotation 270°		

55.60\_ series

**E-G-O**



1

<b>Part No.</b>	390015	<b>Ref. No.</b>	342213
<b>description</b>	thermostat t.max. 180°C temperature range 135-180°C 3-pole 3NC/3NO 16A probe ø 6mm probe L 167/87mm capillary pipe 1770mm capillary pipe isolatedmm gland nut M9x1 shaft ø 6x4.6mm shaft L 23mm shaft position upper rotation 270° with 2 probes with safety thermostat safety temperature 230°C		

safety thermostats

55.32\_ series

**E-G-O**



1

<b>Part No.</b>	375393	<b>Ref. No.</b>	342212
<b>description</b>	safety thermostat switch-off temp. 235°C 3-pole 1CO/2NC 20A probe ø 6mm probe L 87mm capillary pipe 1790mm capillary pipe isolated 1710mm gland nut M9x1 probe SS		

switches and momentary switches  
rocker/momentary rocker switches

30x22mm

**MARQUARDT**



1

<b>Part No.</b>	347774	<b>Ref. No.</b>	341108 341111
<b>description</b>	rocker switch mounting measurements 30x22mm orange 2NO 250V 20A illuminated 0-I connection male faston 6.3mm ambient temperature max. 125/55°C protection IP65		

cam switches

4-position



1

<b>Part No.</b>	300104	<b>Ref. No.</b>	341134
<b>description</b>	cam switch 4 operating positions 3NO/1CO sequence 0-1-2-3 32A shaft ø 6x4.6mm shaft L 23mm connection screw ceramic		

7-position

**E-G-O**



1

<b>Part No.</b>	300025	<b>Ref. No.</b>	341133
<b>description</b>	cam switch 7 operating positions 1NO/2CO sequence 0-1-2-3-4-5-6 16A shaft ø 6x4.6mm shaft L 23mm connection screw 7-position ceramic		
<b>accessories for</b>	300025		
	<b>Part No.</b>	112172	<b>Ref. No.</b> —
	knob universal ø 70mm black without adaptor/dial plate		
	<b>Part No.</b>	112213	<b>Ref. No.</b> —
	knob dial plate silver switch 7-position t.max.°C ED ø 63mm ID ø 45.5mm		
	<b>Part No.</b>	112311	<b>Ref. No.</b> —
	knob adapter shaft ø 6x4.6mm L 0mm with spring		



## lamps

## indicator lights

indicator lamps for socket type SRZ / SDK / SDY / SFK



<b>Part No.</b>	359130	<b>Ref. No.</b>	340732
<b>description</b>	indicator lamp 230V clear connection male faston 6.3mm ø 8mm		



<b>Part No.</b>	359132	<b>Ref. No.</b>	340733
<b>description</b>	indicator lamp green 250V connection male faston 6.3mm protection IP54 ambient temperature max. 85°C		

## linear lamps

## halogen lamps



<b>Part No.</b>	360556	<b>Ref. No.</b>	340623n 340623o
<b>description</b>	halogen lamp socket R7s L 74.9mm 230V 80W OSRAM		

## infrared lamps

## with base type X lug



<b>Part No.</b>	359617	<b>Ref. No.</b>	Q1000
<b>description</b>	infrared lamp 1000W 220V L 365mm lens L 340mm total length 480mm with mounting strap		
<b>For models:</b>	RT 205 MP		

## sockets for linear lamps

## R7s



<b>Part No.</b>	360555	<b>Ref. No.</b>	340412n 340412o
<b>description</b>	lamp socket socket R7s 250V ø 20mm L 43mm W 36mm H 27mm connection cable 400mm mounting distance 28mm with external angle holder length 36mm Qty 1 pcs		

## fans

## axial fans

## ebm-papst



<b>Part No.</b>	601724	<b>Ref. No.</b>	344117n
<b>description</b>	axial fan L 80mm W 80mm H 38mm 230VAC 50/60Hz 9W manuf. no. 8886 VW cable length 315mm metal connection cable ebm-papst fan wheel ø 75mm		

## condensators &amp; interference suppression filters

## operating capacitors

## metal



<b>Part No.</b>	365002	<b>Ref. No.</b>	380129
<b>description</b>	operating capacitor capacity 4µF 400V tolerance 5% 50/60Hz ambient temperature max. -25 to +85°C ø 30mm L 75mm with cable M8 aluminium connection cable 300mm MKP protection IP65		

## gas taps

## MADEC (MP)

## with nozzle outlet









<b>Part No.</b>	106255	<b>Ref. No.</b>	351207
<b>description</b>	gas tap MADEC with nozzle outlet (with nozzle) gas inlet M12x1 (tube ø 8mm) external nozzle ø 2.2mm internal nozzle ø 0.55mm bypass nozzle ø 0.27mm mixing pipe connection M17x1 thermocouple connection M8x1 front fixing M12x1 shaft ø 6x4.6mm shaft L 30/17mm shaft flat upper		
<b>spare parts for</b>	106255		
	<b>Part No.</b>	101051	<b>Ref. No.</b> —
	magnet unit L 27mm D1 ø 12.5mm D2 ø 8.5mm suitable for JUNKERS/EGA/MADEC/SABAF standard		

Table continues overleaf



<b>spare parts for</b>		106255	
	Part No.	101234	Ref. No. —
	union nut T1: M8x1 T2: M15		
<b>accessories for</b>		106255	
	Part No.	101277	Ref. No. —
	olive ID ø 8mm Qty 1 pcs		
	Part No.	101296	Ref. No. —
	union nut thread M12x1 for pipe ø 8mm		
	Part No.	101394	Ref. No. —
	nut thread M17x1 H 3mm WS 19 brass Qty 1 pcs		
	Part No.	101400	Ref. No. —
	air mixing tube thread M17x1 suitable for L350, L700		

**GASTRO**PARTS.COM

