



**GASTROPARTS**

# Technoblock

- [EN]** Equipment
- [DE]** Geräte
- [ES]** Aparatos
- [FR]** Équipement
- [IT]** Attrezzature
- [PL]** Urządzenia
- [RU]** Оборудование

✉ [gastroparts@gastroparts.com](mailto:gastroparts@gastroparts.com)

☎ +48 56 657 00 66

📘 [fb.com/gastroparts.global](https://fb.com/gastroparts.global)

**GASTROPARTS.COM**

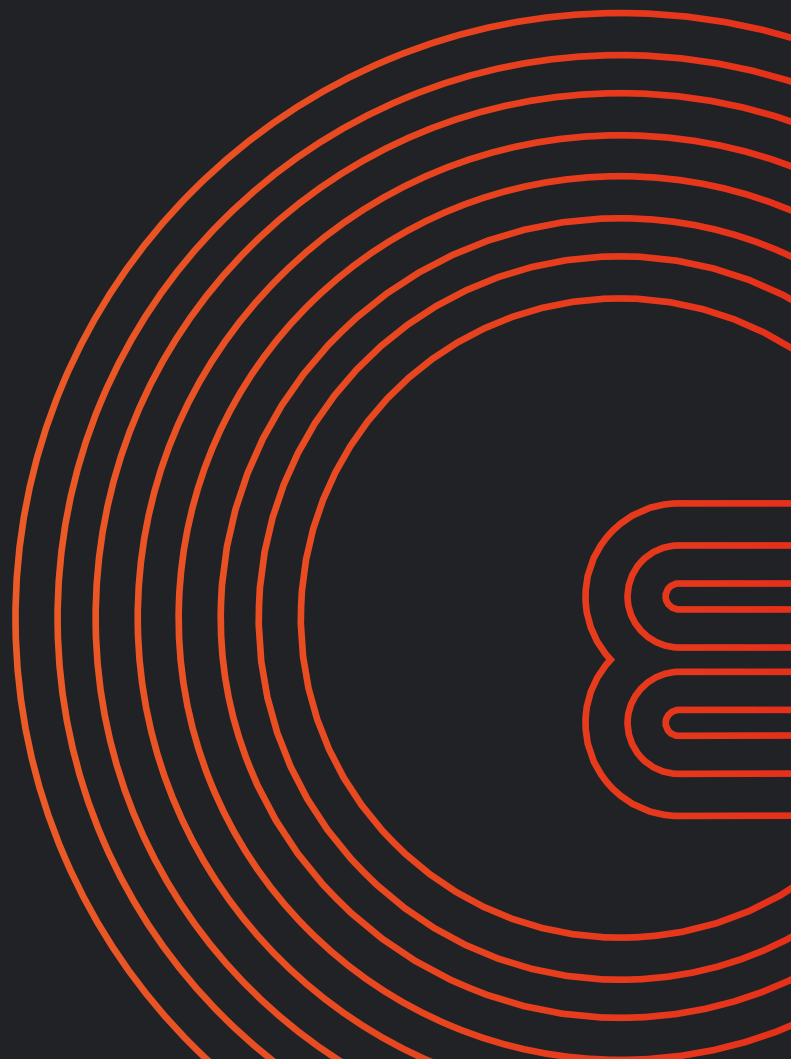



## heating elements

### heating elements for refrigeration

#### heating elements for defrosting



|                    |   |                 |                     |
|--------------------|---|-----------------|---------------------|
| <b>Part No.</b>    | 420296  | <b>Ref. No.</b> | 3RST188<br>4RSBI003 |
| <b>description</b> | heating element 1300W 230V L 1200mm W 60mm H 115mm cable length 2000mm tube ø 8.5mm immersion heater defrosting |                 |                     |

## switches and momentary switches

### push/momentary push switches

#### 19x13mm



|                    |   |                 |                     |
|--------------------|---|-----------------|---------------------|
| <b>Part No.</b>    | 347692  | <b>Ref. No.</b> | 3INT277<br>4INTS008 |
| <b>description</b> | push switch mounting measurements 19x13mm green 1NO/indicator light 250V 15A lamp connection male faston 4.8mm ambient temperature max. 105/55°C protection IP65 with cover cap |                 |                     |



|   |  |                 |                     |
|---|--|-----------------|---------------------|
| <b>Part No.</b>   | 347691 <sup>1</sup>  | <b>Ref. No.</b> | 3INT283<br>4INTS007 |
| <b>description</b>  | push switch mounting measurements 19x13mm green 2NO 250V 15A illuminated refrigeration connection male faston 4.8mm ambient temperature max. 105/55°C protection IP65 with cover cap |                 |                     |
| <b>spare parts for</b>  | 347691   |                 |                     |
|  | <b>Part No.</b>  | 301064          | <b>Ref. No.</b> —   |
|   | protective cover for pressure switch external size 23.4x17.4mm internal size 19x13mm H 7.5mm clear mounting measurementsmm   |                 |                     |

<sup>1</sup>illuminated

## contactors

### ABB

#### power contactors



|                    |  |                 |         |
|--------------------|--|-----------------|---------|
| <b>Part No.</b>    | 381504   | <b>Ref. No.</b> | 3TLR271 |
| <b>description</b> | power contactor resistive load 25A 230VAC (AC3/400V) 5.5kW main contacts 2NO connection screw type A11-30-10 |                 |         |

## relays

### power relays

#### with male contacts

#### female contact 6.3mm

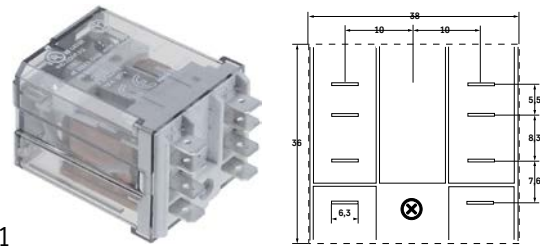

|                    |  |                 |                     |
|--------------------|--|-----------------|---------------------|
| <b>Part No.</b>    | 380955   | <b>Ref. No.</b> | 3RLM076<br>4RELF003 |
| <b>description</b> | relay FINDER 230VAC 16A 2CO connection F6.3 manuf. no. 62.82.8.230.0009 250V 2-pole connection male faston 6.3mmmm |                 |                     |

## transformers

### encapsulated transformers

#### PMA



|                    |   |                 |                     |
|--------------------|---|-----------------|---------------------|
| <b>Part No.</b>    | 379054  | <b>Ref. No.</b> | 3TRF150<br>4TRFS022 |
| <b>description</b> | transformer primary 230VAC secondary 12VAC 3VA secondary 0.25A H 40mm L 45mm W 50mm connection screw 50/60Hz type 153/M |                 |                     |



## electronic controllers













## DIXELL

## refrigeration controllers

## built-in version



1

|   |  |                 |                                     |
|---|--|-----------------|-------------------------------------|
| <b>Part No.</b>   | 402144   | <b>Ref. No.</b> | 3CTL183                             |
| <b>description</b>  | electronic controller DIXELL XR60CX -5NOC1 mounting measurements 71x29mm 230V voltage AC NTC/PTC relay outputs 3 NO-20A(8) CO-8A(3) NO-5A(2) NTC/PTC NTC/PTC DI -50 up to +150°C display 3½ digits |                 |                                     |
| <b>accessories for</b>  | 402144   |                 |                                     |
|    | <b>Part No.</b>  | 378194          | <b>Ref. No.</b> —                   |
|   | temperature probe NTC 10kOhm cable PVC probe -20 up to +80°C cable -10 up to 100°C probe ø7x24.5mm cable length 1.5m without screw connection 2-wire   |                 |                                     |
|    | <b>Part No.</b>  | 378551          | <b>Ref. No.</b> —                   |
|   | adapter for reducer mounting measurements 71x29mm  |                 |                                     |
|  | <b>Part No.</b>  | 379052          | <b>Ref. No.</b> —                   |
|   | temperature probe PTC 1kOhm cable silicone probe -50 up to +150°C cable -50 up to +180°C probe ø6x40mm cable length 1.5m without screw connection 2-wire   |                 |                                     |
|  | <b>Part No.</b>  | 379053          | <b>Ref. No.</b> —                   |
|   | temperature probe PTC 1kOhm cable PVC probe -50 up to +150°C cable -10 up to 100°C probe ø6x30mm cable length 3m without screw connection 2-wire   |                 |                                     |
|  | <b>Part No.</b>  | 379057          | <b>Ref. No.</b> —                   |
|   | temperature probe NTC 10kOhm cable PVC probe -20 up to +80°C cable -10 up to 100°C probe ø6x25mm cable length 3m 2-wire  |                 |                                     |
|  | <b>Part No.</b>  | 379064          | <b>Ref. No.</b> —                   |
|   | temperature probe PTC 1kOhm cable silicone probe -50 up to +150°C cable -50 up to +180°C probe ø6x40mm cable length 3m without screw connection 2-wire   |                 |                                     |
|  | <b>Part No.</b>  | 379160          | <b>Ref. No.</b> 3SNS131<br>4SND5111 |
|   | temperature probe NTC 10kOhm cable thermoplastic probe -40 up to +110°C cable -40 up to +110°C probe ø6x14mm cable length 1.5m without screw connection 2-wire                                     |                 |                                     |
|  | <b>Part No.</b>  | 379161          | <b>Ref. No.</b> —                   |
|   | temperature probe NTC 10kOhm cable thermoplastic probe -40 up to +110°C cable -40 up to +110°C probe ø6x14mm cable length 3m without screw connection 2-wire                                       |                 |                                     |
|  | <b>Part No.</b>  | 379343          | <b>Ref. No.</b> —                   |
|   | temperature probe NTC 10kOhm cable silicone probe -40 up to +110°C cable -50 up to +180°C probe ø6x40mm cable length 3m 2-wire   |                 |                                     |
|  | <b>Part No.</b>  | 379458          | <b>Ref. No.</b> —                   |
|   | temperature probe NTC 10kOhm cable silicone probe -40 up to +110°C cable -50 up to +180°C probe ø6x40mm cable length 1.5m without screw connection 2-wire  |                 |                                     |
|  | <b>Part No.</b>  | 379782          | <b>Ref. No.</b> —                   |
|   | temperature probe PTC 1kOhm cable thermoplastic probe -50 up to +150°C cable -40 up to +110°C probe ø6x14mm cable length 3m 2-wire resistor 1kOhm  |                 |                                     |
|  | <b>Part No.</b>  | 402818          | <b>Ref. No.</b> —                   |
|   | programming key 4K for electronic controller DIXELL  |                 |                                     |

## SHANGFANG

## accessories



1

|                    |   |                 |                     |
|--------------------|---|-----------------|---------------------|
| <b>Part No.</b>    | 379054  | <b>Ref. No.</b> | 3TRF150<br>4TRFS022 |
| <b>description</b> | transformer primary 230VAC secondary 12VAC 3VA secondary 0.25A H 40mm L 45mm W 50mm connection screw 50/60Hz type 153/M |                 |                     |

## probes

## universal probes

## temperature probes

1



|                    |  |                 |                     |
|--------------------|--|-----------------|---------------------|
| <b>Part No.</b>    | 379160   | <b>Ref. No.</b> | 3SNS131<br>4SND5111 |
| <b>description</b> | temperature probe NTC 10kOhm cable thermoplastic probe -40 up to +110°C cable -40 up to +110°C probe ø6x14mm cable length 1.5m without screw connection 2-wire |                 |                     |

## electronics

## PCBs



1

|                    |   |                 |                     |
|--------------------|---|-----------------|---------------------|
| <b>Part No.</b>    | 402940                                      | <b>Ref. No.</b> | 3SCH173<br>4SCHS090 |
| <b>description</b> | main PCB CSK 120 L 124mm W 100mm type MIR90 |                 |                     |



## compressors

### SECOP DANFOSS

R404a/R507

HMBP monophase

High/Medium evaporation temperature above -20/-15 °C



1

|                    |   |                 |          |
|--------------------|---|-----------------|----------|
| <b>Part No.</b>    | 605113  | <b>Ref. No.</b> | 3CMP2154 |
| <b>description</b> | compressor coolant R404a/R507 type SC18MLX.3 220-240V 50Hz HMBP 14kg 1HP cylinder capacity 17.68cm <sup>3</sup> CSR H 219mmWW 947W 1178W 1454W 1780W 2162W 2606WW test method ASHRAE (50Hz) |                 |          |

## fans

### refrigeration fans

refrigeration motors universal

miscellaneous



1

|                    |   |                 |                                 |
|--------------------|---|-----------------|---------------------------------|
| <b>Part No.</b>    | 602186  | <b>Ref. No.</b> | 3MVN027<br>4MTNM051<br>4MTNM151 |
| <b>description</b> | fan motor 83-18W 230V 50/60Hz cable length 1050mm 1350/1500rpm MA-VIB |                 |                                 |

cold air circulating fans (complete)

ebm-papst

A4E series

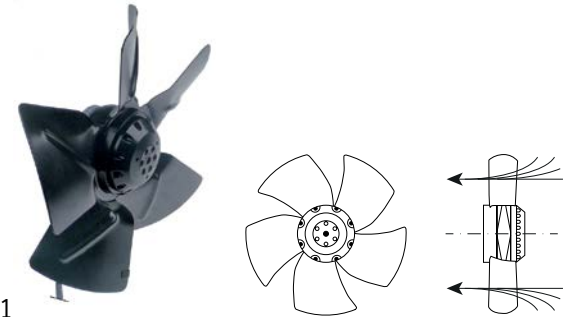

1

|                        |   |                 |                     |
|------------------------|---|-----------------|---------------------|
| <b>Part No.</b>        | 601623  | <b>Ref. No.</b> | 3MOT049<br>4MTVZ004 |
| <b>description</b>     | fan A4E315-AC08-19 fan wheel ø 315mm blades 5 230V 50Hz 95W 1370rpm cable length 450mm ebm-papst sucking suitable capacitor 3µF                               |                 |                     |
| <b>accessories for</b> | 601623  |                 |                     |
|                        | <b>Part No.</b>   | <b>Ref. No.</b> | —                   |
|                        | capacitor capacity 3µF 450V tolerance 5% 50/60Hz ambient temperature max. -25 to +85°C ø 25mm L 56mm M8 plastic connection cable 250mm 416.17.77GF protection |                 |                     |

## evaporators

for fridges

producer-specific



1

|                    |            |                 |                     |
|--------------------|------------|-----------------|---------------------|
| <b>Part No.</b>    | 750213     | <b>Ref. No.</b> | 3EVP416<br>4EVPX101 |
| <b>description</b> | evaporator |                 |                     |

**GASTRO**PARTS.COM

