

# Stahl

- [EN]** Equipment
- [DE]** Geräte
- [ES]** Aparatos
- [FR]** Équipement
- [IT]** Attrezzature
- [PL]** Urządzenia
- [RU]** Оборудование

✉ [gastroparts@gastroparts.com](mailto:gastroparts@gastroparts.com)

☎ +48 56 657 00 66

📘 [fb.com/gastroparts.global](https://fb.com/gastroparts.global)



## heating elements

### heating elements for bain maries

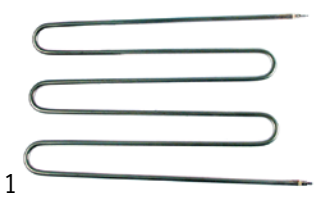

1

<b>Part No.</b>	418280	<b>Ref. No.</b>	160031
<b>description</b>	heating element 1200W 230V heating circuits 1 L 410mm W 233mm connection M4 connection distance 225mm tube ø 8.5mm dry heating element bain marie		

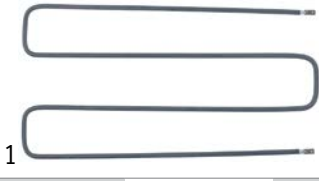





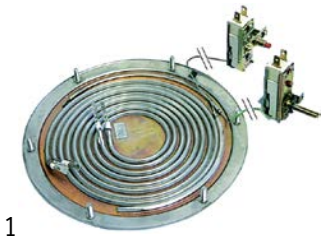

1

<b>Part No.</b>	415545	<b>Ref. No.</b>	160025
<b>description</b>	heating element 855W 240V heating circuits 1 L 380mm L1 410mm W 204mm connection male faston 6.3mm connection distance 196mm tube ø 6.5mm dry heating element		

### bottom heaters



1

<b>Part No.</b>	415661	<b>Ref. No.</b>	160087	
<b>description</b>	bottom heater 3000W 230V heating circuits 2 ø 196mm safety thermostat 250°C thermostat 128°C M5 mounting distance 180mm			
<b>spare parts for</b>	415661			
	<b>Part No.</b>	102067	<b>Ref. No.</b>	—
	nut thread M8x1 H 3mm brass Qty 1 pcs type SEF 1			
	<b>Part No.</b>	375137	<b>Ref. No.</b>	—
	safety thermostat switch-off temp. 250°C 1-pole 16A probe ø 3.03mm probe L 160mm capillary pipe 880mm capillary pipe isolated 800mm gland nut probe SS with curved probe			
	<b>Part No.</b>	375300	<b>Ref. No.</b>	—
	thermostat t.max. 128°C temperature range 35-128°C 1-pole 1NO 16A probe ø 3.1mm probe L 174mm capillary pipe 880mm capillary pipe isolated 800mm gland nut shaft L 23mm shaft position lower rotation 270°			
<b>accessories for</b>	415661			
	<b>Part No.</b>	520323	<b>Ref. No.</b>	—
	gasket ID ø 160mm ED ø 200mm hole distance 90/180mm hole ø 7mm silicone for bottom heaters			
	<b>Part No.</b>	520324	<b>Ref. No.</b>	—
	counterflange ID ø 160mm ED ø 200mm hole distance 90/180mm hole ø 7mm SS for bottom heaters			
	<b>Part No.</b>	551083	<b>Ref. No.</b>	—
	cap for safety thermostat thread M8x1			

### heating plates

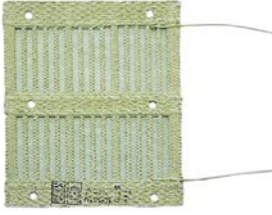

1



<b>Part No.</b>	415734	<b>Ref. No.</b>	160055
<b>description</b>	heating grid 1000W 230V for heated cabinet heating circuits 1 L 220mm W 260mm		

### ceramic heaters

#### 245x60mm





1

<b>Part No.</b>	415101	<b>Ref. No.</b>	160065	
<b>description</b>	ceramic emitter 250W 230V cable beaded cord L 245mm W 60mm H 35mm			
<b>spare parts for</b>	415101			
	<b>Part No.</b>	415109	<b>Ref. No.</b>	—
	spring clip			
<b>accessories for</b>	415101			
	<b>Part No.</b>	415110	<b>Ref. No.</b>	—
	reflector L 245mm W 95mm H 31mm thickness 0.75mm hole ø 15x40mm			



1

<b>Part No.</b>	415102	<b>Ref. No.</b>	160070	
<b>description</b>	ceramic emitter 400W 230V cable beaded cord L 245mm W 60mm H 35mm			
<b>spare parts for</b>	415102			
	<b>Part No.</b>	415109	<b>Ref. No.</b>	—
	spring clip			
<b>accessories for</b>	415102			
	<b>Part No.</b>	415110	<b>Ref. No.</b>	—
	reflector L 245mm W 95mm H 31mm thickness 0.75mm hole ø 15x40mm			



## accessories



<b>Part No.</b>	550871	<b>Ref. No.</b>	160095
<b>description</b>	insulator female H 6mm hole $\varnothing$ 9.2mm $\varnothing$ 15mm		

## energy regulators

## EGO

## 1-circuit



<b>Part No.</b>	380015	<b>Ref. No.</b>	167115
<b>description</b>	energy regulator 230V 13A single-circuit turn direction right shaft $\varnothing$ 6x4.6mm shaft L 23mm mounting thread M4 power release 6-100% no. 50.57021.010		

## thermostats

## control and safety thermostats

## EGO

## control thermostats

## 55.34\_ series



<b>Part No.</b>	375143	<b>Ref. No.</b>	162020
<b>description</b>	thermostat t.max. 110°C temperature range 32-110°C 3-pole 3NO 16A probe $\varnothing$ 6mm probe L 138mm capillary pipe 1480mm capillary pipe isolated 1100mm gland nut M9x1 shaft $\varnothing$ 6x4.6mm shaft L 23mm shaft position upper rotation 270°		

## E-G-O



<b>Part No.</b>	375019	<b>Ref. No.</b>	162015
<b>description</b>	thermostat t.max. 85°C temperature range 30-85°C 3-pole 3NO 16A probe $\varnothing$ 6mm probe L 131mm capillary pipe 1440mm capillary pipe isolatedmm gland nut M9x1 shaft $\varnothing$ 6x4.6mm shaft L 23mm shaft position upper rotation 270°		

## control thermostats with operation switch

## 55.34\_ series





<b>Part No.</b>	375876	<b>Ref. No.</b>	162015
<b>description</b>	thermostat t.max. 85°C temperature range 30-85°C 3-pole 3NO 16A probe $\varnothing$ 6mm probe L 131mm capillary pipe 1440mm capillary pipe isolatedmm gland nut M9x1 shaft $\varnothing$ 6x4.6mm shaft L 23mm shaft position upper shaft position° rotation 270° outer switch 2NO with operation switch		

## switches and momentary switches

## cam switches

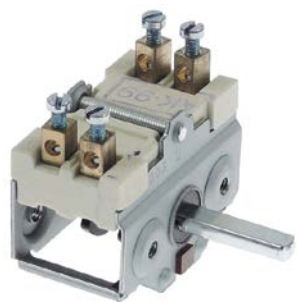
## on/off



<b>Part No.</b>	300020	<b>Ref. No.</b>	167100 A67100	
<b>description</b>	cam switch 4 operating positions 2NO sequence 0-1-0-1 16A shaft $\varnothing$ 6x4.6mm shaft L 23mm connection screw ceramic			
<b>accessories for</b>	300020			
	<b>Part No.</b>	110135	<b>Ref. No.</b>	—
	rosette knob up to $\varnothing$ 52mm			
	<b>Part No.</b>	110231	<b>Ref. No.</b>	—
	knob switch 0-1-0-1 t.max.°C°C $\varnothing$ 50mm shaft $\varnothing$ 6x4.6mm shaft flat upper black			



7-position

1

<b>Part No.</b>	301233	<b>Ref. No.</b>	Nockenschalter 7-Tak
<b>description</b>	cam switch 7-position		

4 operating positions

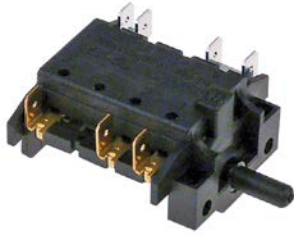

1

<b>Part No.</b>	301199	<b>Ref. No.</b>	167105
<b>description</b>	cam switch 4 operating positions 3NO sequence 0-1-2-3 16A shaft ø 6x4.6mm shaft L 15mm connection male faston 6.3mm		

lamps

indicator lights

indicator lights (complete)

ø14mm

with plug-in socket



1

<b>Part No.</b>	359677	<b>Ref. No.</b>	168080
<b>description</b>	indicator light ø 14mm yellow 230V connection F2.8/F6.3		

linear lamps

infrared lamps

with base type R7s



1

<b>Part No.</b>	359676	<b>Ref. No.</b>	160063 161030
<b>description</b>	infrared lamp socket R7s L 190mm 230V 350W IMPORT t.max. 500°C		

sockets for linear lamps

R7s



1

<b>Part No.</b>	359717	<b>Ref. No.</b>	160063
<b>description</b>	lamp socket socket R7s 250V ø 18mm Lmm H 31mm connection cable 320mm mounting distance 28mm holder length 37mm cable material PTFE		

fans

hot air fans

ebm-papst



1

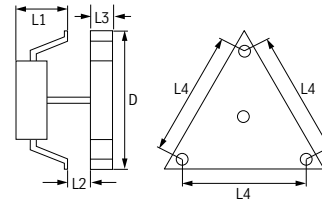

<b>Part No.</b>	601249	<b>Ref. No.</b>	161030
<b>description</b>	hot air fan 230V 32W 0.27A L1 60mm L2 20mm L3 20mm L4 157mm fan wheel ø 150mm ebm-papst type R2K150-AC01-15		

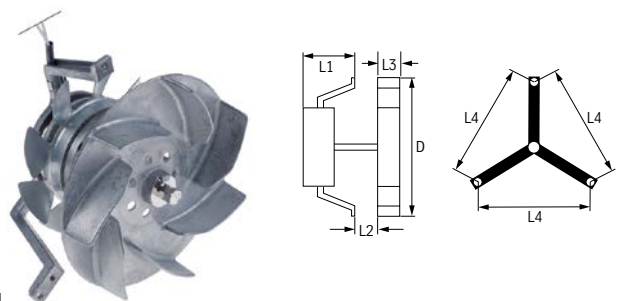

1

<b>Part No.</b>	601013	<b>Ref. No.</b>	161.030
<b>description</b>			



# pullouts

## drawer slides

### producer-specific



<b>Part No.</b>	692732	<b>Ref. No.</b>	1120.052
<b>description</b>	telescopic slide pair L 550mm pull-out length 590mm total length 1140mm Qty 1 pair capacity 50kg W 15mm H 60mm mounting pos. right/left SS telescopic		

1			
<b>Part No.</b>	691636	<b>Ref. No.</b>	120.056 FR 6010 580lg
<b>description</b>	telescopic slide pair L 580mm pull-out length 620mm Qty 1 pair capacity 50kg W 15mm H 60mm mounting pos. right/left SS telescopic L1 35mm L2 548mm		

**GASTRO**PARTS.COM

