



GASTROPARTS

Metalcarrelli

- [EN]** Equipment
- [DE]** Geräte
- [ES]** Aparatos
- [FR]** Équipement
- [IT]** Attrezzature
- [PL]** Urządzenia
- [RU]** Оборудование

✉ gastroparts@gastroparts.com

☎ tel. +48 56 657 00 66

📘 fb.com/gastroparts.global

GASTROPARTS.COM





heating elements

heating elements for bain maries

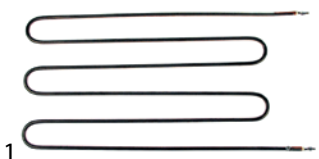

Part No.	418334	Ref. No.	003001040005 R1515
description	heating element 1400W 230V heating circuits 1 L 555mm L1 45mm W 270mm connection M4 connection distance 262mm tube ø 8mm dry heating element L2 510mm H 20mm		

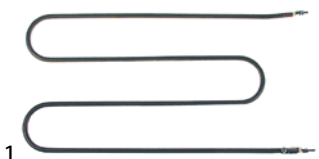

Part No.	418335	Ref. No.	003001040010 R1545
description	heating element 500W 230V heating circuits 1 L 430mm L1 38mm W 280mm connection M4 connection distance 271mm tube ø 8.5mm dry heating element L2 392mm H 16mm		

heating cables

connection on both sides

with wire end ferrules



Part No.	418336	Ref. No.	R1504
description	heating cable 230W 230V L 4000mm silicone impregnated glass fibre braiding ø 3mm connection terminal		



Part No.	418337	Ref. No.	R1506
description	heating cable 313W 230V L 6600mm silicone impregnated glass fibre braiding ø 3mm connection terminal		



Part No.	418338	Ref. No.	R1508
description	heating cable 384W 230V L 7900mm silicone impregnated glass fibre braiding ø 4mm connection terminal		

with male fastons



Part No.	419108	Ref. No.	003001040011 003001040018
description	heating cable 250W 230V L 4000mm silicone ø 3mm connection female faston 6.3mm		



Part No.	419107	Ref. No.	003001040012 003001040019
description	heating cable 300W 230V L 6000mm silicone ø 3mm		



Part No.	419106	Ref. No.	003001040013 003001040020
description	heating cable 450W 230V L 8000mm silicone ø 3mm		



Part No.	418339	Ref. No.	003001040014 003001040021 R1510
description	heating cable 600W 230V L 9900mm silicone ø 3mm connection male faston 6.3mm		

immersion heating elements

with compression flange 70 x 26mm



Part No.	417278	Ref. No.	003001020002 R1535
description	heating element 1950W 230V heating circuits 3 L 230mm W 70mm washing		

thermostats

control and safety thermostats

IMIT / TEMPOMATIC / ARTHERMO

control thermostats



Part No.	375404	Ref. No.	003201820001
description	thermostat t.max. 110°C temperature range 0-90°C 1-pole 1CO 15A probe ø 6mm probe L 104mm capillary pipe 1400mm capillary pipe isolated 1350mm gland nut shaft ø 6x4.6mm shaft L 18mm shaft position upper rotation 270° probe material copper 400V		



PRODIGY / FIRT

control thermostats



Part No.	390723	Ref. No.	003201820002
----------	--------	----------	--------------

description thermostat PRODIGY temperature range -35 up to +35°C probe ø 6mm probe L 110mm capillary pipe 1500mm type TR/711-N

accessories for 390723



Part No.	110305	Ref. No.	—
----------	--------	----------	---

knob thermostat t.max. 35°C temperature range -35 up to +35°C ø 45mm shaft ø 6x4.6mm shaft flat inclined rotation 270° white

various

control thermostats with operation switch



Part No.	375762	Ref. No.	R0090
----------	--------	----------	-------

description thermostat t.max. 120°C temperature range 30-120°C 1-pole 1CO 16A probe ø 6.5mm probe L 98mm capillary pipe 1450mm capillary pipe isolated 1350mm rotation 270°

switches and momentary switches

rocker/momentary rocker switches

30x22mm

labelled



Part No.	300125	Ref. No.	R0056
----------	--------	----------	-------

description rocker switch mounting measurements 30x22mm green 2NO 230V 16A 0-I connection male faston 6.3mm ambient temperature max. 125/55°C protection IP65 with cover cap

accessories for 300125



Part No.	301036	Ref. No.	—
----------	--------	----------	---

protective cover internal size 30x22mm for rocker switch mounting measurementsmm



Part No.	301164	Ref. No.	R0056 R0096
----------	--------	----------	----------------

description rocker switch mounting measurements 30x22mm green 2NO 250V 16A illuminated connection male faston 6.3mm ambient temperature max. 85°C protection IP65 with cover cap

accessories for 301164



Part No.	301036	Ref. No.	—
----------	--------	----------	---

protective cover internal size 30x22mm for rocker switch mounting measurementsmm

lamps

indicator lights

indicator lights (complete)

ø10mm

with plug-in socket

1

Part No.		Ref. No.	R0095
----------	--	----------	-------

description indicator light ø 10mm 230V red cable length 200mm

hard-glass infrared lamps



1

Part No.	359463	Ref. No.	003151620002 A9560
----------	--------	----------	-----------------------

description infrared lamp socket E27 240V 250W ø 125mm L 173mm type BR125 red hard glas

electronic controllers

ELIWELL

universal controllers

built-in version















1

Part No.	379994	Ref. No.	R0052
----------	--------	----------	-------

description electronic controller ELIWELL mounting measurements 71x29mm 230V voltage AC NTC/PTC defr. funct. no



 <p>71 x 29mm</p>			
1			
Part No.	379690	Ref. No.	R0092
description	electronic controller ELIWELL type ICPlus902 model ICP16D0750000 mounting measurements 71x29mm 230V voltage AC NTC/PTC relay outputs 1 CO-15A(8) NTC/PTC built-in depth 60mm defr. funct. -50 up to +150°C display 3½ digits		
accessories for	379690		
	Part No.	378194	Ref. No. —
	temperature probe NTC 10kOhm cable PVC probe -20 up to +80°C cable -10 up to 100°C probe ø7x24.5mm cable length 1.5m without screw connection 2-wire		
	Part No.	379052	Ref. No. —
	temperature probe PTC 1kOhm cable silicone probe -50 up to +150°C cable -50 up to +180°C probe ø6x40mm cable length 1.5m without screw connection 2-wire		
	Part No.	379053	Ref. No. —
	temperature probe PTC 1kOhm cable PVC probe -50 up to +150°C cable -10 up to 100°C probe ø6x30mm cable length 3m without screw connection 2-wire		
	Part No.	379057	Ref. No. —
	temperature probe NTC 10kOhm cable PVC probe -20 up to +80°C cable -10 up to 100°C probe ø6x25mm cable length 3m 2-wire		
	Part No.	379064	Ref. No. —
	temperature probe PTC 1kOhm cable silicone probe -50 up to +150°C cable -50 up to +180°C probe ø6x40mm cable length 3m without screw connection 2-wire		
	Part No.	379142	Ref. No. —
	temperature probe PTC 1kOhm cable PVC probe -50 up to +150°C cable -10 up to 100°C probe ø6x30mm cable length 1.5m without screw connection 2-wire		
	Part No.	379160	Ref. No. —
	temperature probe NTC 10kOhm cable thermoplastic probe -40 up to +110°C cable -40 up to +110°C probe ø6x14mm cable length 1.5m without screw connection 2-wire		
	Part No.	379161	Ref. No. —
	temperature probe NTC 10kOhm cable thermoplastic probe -40 up to +110°C cable -40 up to +110°C probe ø6x14mm cable length 3m without screw connection 2-wire		
	Part No.	379343	Ref. No. —
	temperature probe NTC 10kOhm cable silicone probe -40 up to +110°C cable -50 up to +180°C probe ø6x40mm cable length 3m 2-wire		
	Part No.	379458	Ref. No. —
	temperature probe NTC 10kOhm cable silicone probe -40 up to +110°C cable -50 up to +180°C probe ø6x40mm cable length 1.5m without screw connection 2-wire		
	Part No.	379781	Ref. No. —
	temperature probe PTC 1kOhm cable thermoplastic probe -50 up to +150°C cable -40 up to +110°C probe ø6x14mm cable length 1.5m without screw connection 2-wire		
	Part No.	379782	Ref. No. —
	temperature probe PTC 1kOhm cable thermoplastic probe -50 up to +150°C cable -40 up to +110°C probe ø6x14mm cable length 3m 2-wire resistor 1kOhm		

fans

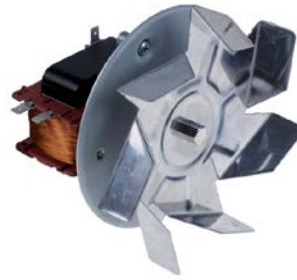

hot air fans

miscellaneous

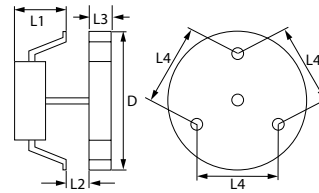

1



Part No.	601011	Ref. No.	R1536
description	hot air fan 220-240V 40W 50/60Hz L1 65mm L2 15mm L3 25mm L4 87mm fan wheel ø 150mm FIME type C25R8023CLH		
accessories for	601011		
	Part No.	550879	Ref. No. —
	insulation ø 130mm thickness 3mm hole ø 20mm for hot air fan		
	Part No.	601260	Ref. No. —
	nut thread M6L IT for hot air fan		

electric accessories

cables

spiral cables



1

Part No.	550101	Ref. No.	003553280001
description	spiral cable plug type CEE7/7 type E+F 1.5mm ² 3-pole with plug L 500mm expansion 5:1 countries A/B/D/F/I orange t.max. 70°C		



gas burners

hob burners

producer-specific hob burners

METALCARRELLI

universal



1

Part No.	105927	Ref. No.	009540650002 A0135
description	burner unit L 350mm W 250mm number of burners: 1 complete 1.75kW LPG		



1

Part No.	105928	Ref. No.	009540650003 A0136
description	burner unit L 470mm W 340mm number of burners: 2 complete		

equipment feet and end caps

bolting feet



1

Part No.	693442	Ref. No.	001804340001
description	equipment foot ø 29mm H 15mm rubber bore ø 6mm Qty 1 pcs		

DERBY RUOTE

with bolt hole

plastic



1

Part No.	701413	Ref. No.	005201250020
description	swivel castor ø 125mm bolt hole bolt hole ø 13mm housing polypropylene capacity 100kg bearing ball bearing wheel body polypropylene tread TPE tyres H 161mm wheel width 30mm Qty 1 pcs		

miscellaneous

with bolt hole

ø125mm



1

Part No.	700342 ¹	Ref. No.	005201250021 83022000 R3207F
description	swivel castor with swivel brake ø 125mm plug fitting 21x21mm housing zinc-plated sheet steel bearing slide bearing H 157mm wheel width 27mm		

¹with swivel brake

with spigot

ø100mm



1

Part No.	700339	Ref. No.	005101000001 R3220
description	swivel castor ø 100mm threaded shaft M10 housing chrome-plated steel bearing ball bearing H 140mm wheel width 25mm Qty 1 pcs		



1

Part No.	700336	Ref. No.	005151250002 R3205F
description	swivel castor with swivel brake ø 125mm plug fitting ø10x38mm housing chrome-plated steel bearing slide bearing wheel body polypropylene tread TPE tyres Qty 1 pcs		

ø125mm



1

Part No.	700341	Ref. No.	00520125000 005201250001 R3207
description	swivel castor ø 125mm plug fitting 21x21mm housing zinc-plated sheet steel bearing slide bearing H 157mm wheel width 27mm		



 <p>1</p>			
Part No.	700340	Ref. No.	005151250001 R3205
description	swivel castor ø 125mm plug fitting ø10x38mm housing zinc-plated sheet steel bearing slide bearing tread thermoplastic rubber H 157mm wheel width 27mm		

bumper angles

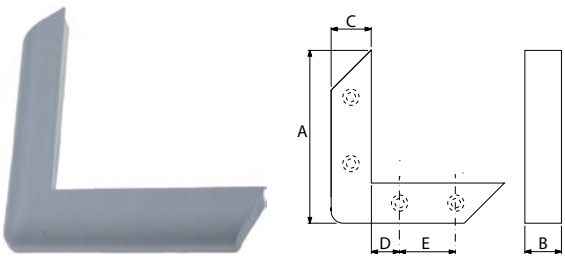
 <p>1</p>			
Part No.	692112	Ref. No.	233004680002 A0034
description	bumper angle outer length 180mm inner length 145mm W 32mm H 30mm mounting distance 51mm hole distance 42mm hole ø 3mm plastic grey		

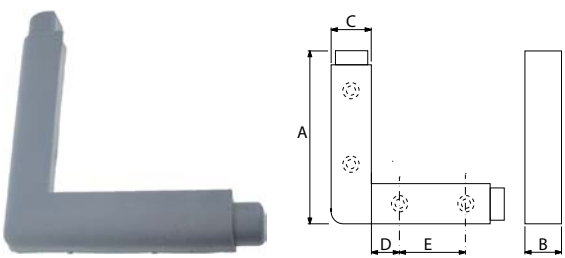
 <p>1</p>			
Part No.	692113	Ref. No.	233004680001
description	bumper angle outer length 180mm inner length 148mm W 34mm H 22mm mounting distance 52mm hole distance 48mm hole ø 3mm plastic grey		

valves and tank inlets

ball valves

universal

mini ball valves

 <p>1</p>			
Part No.	520724	Ref. No.	M2001020001
description	ball valve connection 1/2" IT - 1/2" ET DN10 total length 45mm chrome-plated brass		

GASTROPARTS.COM

