



GASTROPARTS

Mecnosud

- [EN]** Equipment
- [DE]** Geräte
- [ES]** Aparatos
- [FR]** Équipement
- [IT]** Attrezzature
- [PL]** Urządzenia
- [RU]** Оборудование

✉ gastroparts@gastroparts.com

☎ tel. +48 56 657 00 66

📘 fb.com/gastroparts.global

GASTROPARTS.COM





switches and momentary switches

rocker/momentary rocker switches

30x22mm

blank



1

Part No.	301005	Ref. No.	DLX30026
-----------------	--------	-----------------	----------

description rocker switch mounting measurements 30x22mm red 2NO 250V 16A illuminated connection male faston 6.3mm ambient temperature max. 125/55°C protection IP65 with protecting cover

accessories for 301005



Part No.	301036	Ref. No.	—
-----------------	--------	-----------------	---

protective cover internal size 30x22mm for rocker switch mounting measurementsmm

microswitches

roller actuated

roller 0°



1

Part No.	347155	Ref. No.	FC12 MIC00308
-----------------	--------	-----------------	------------------

description microswitch with roller plunger 15A 1CO connection screw thread M12x1 type Z15G1308

rotary switches

BRETER

rotary switches



1

Part No.	347156	Ref. No.	IMX0173 IMX0C173 IMXGC173
-----------------	--------	-----------------	---------------------------------

description rotary switch 3 1-0-2 sets of contacts 8 type LE2-16-7293 690V 16A shaft ø 8x9mm shaft L 20mm shaft star-shaped with knob connection screw

electronics

PCBs



1

Part No.	402320	Ref. No.	IMXNH015
-----------------	--------	-----------------	----------

description PCB



1

Part No.	697124	Ref. No.	Scheda Elettrica B7
-----------------	--------	-----------------	---------------------

description PCB 230/400V



1

Part No.	401640	Ref. No.	DLX30003
-----------------	--------	-----------------	----------

description PCB for dough rolling machine DL 30-40 230V

keypads

front foils



1

Part No.	401641	Ref. No.	DLX30006
-----------------	--------	-----------------	----------

description keypad foil dough rolling machine DL 30-40 L 100mm W 80mm



equipment-specific units

for dough mixers

chains

roller chains 06B-1 single



1			
Part No.	697127	Ref. No.	CA 3/8(42anelli-IM18T) IMX12022
description	roller chain DIN/ISO 06 B-1 splitting 3/8" / 9.525mm links 42 internal width 5.72mm rollerø 6.35mm single		

dough hooks

with mounting thread



1			
Part No.	697287	Ref. No.	IMX25021 SP25/38 spiral hook IM
description	dough hook thread M22x1.5 usable height 290mm IM25T-IM38T		

for dough roller

wipers



1			
Part No.	696339	Ref. No.	DL030032
description	wiper for dough roller L 355mm mounting pos. front		



1			
Part No.	696340	Ref. No.	DL030031
description	wiper for dough roller L 355mm mounting pos. rear DL30/DL30M		

roll units (complete)



1			
Part No.	691234	Ref. No.	DL030100
description	roller assembly L 165mm mounting pos. upper		



rollers



1			
Part No.	694293	Ref. No.	DLX40030
description	roller for dough roller L 420mm ø 48mm mounting pos. bottom in the front		

holders



1			
Part No.	692301	Ref. No.	DLX30040+DLX30054+DLX30055+DLX30056 Mor
description	lever complete hole ø 9.8mm H 21mm hole distance 32mm		
spare parts for	692301		
	Part No.	697346	Ref. No.
			—
accessories for	692301		
	Part No.	691637	Ref. No.
			10303020
			roll pin ø 3mm L 20mm

levers



1

Part No.	691233	Ref. No.	DL030018
description	lever shaft intake ø 8mm L 220mm DL30		

couplings



1

Part No.	694263	Ref. No.	DLX30035
description	coupling ø 36mm ID ø 26mm H 17mm		



1

Part No.	694264	Ref. No.	DLX30021
description	coupling ø 42mm ID ø 25mm H 12mm		

pulleys



1

Part No.	691230 ¹	Ref. No.	DLX30013
description	round belt pulley disc ø 94mm double shaft intake ø 14x11mm groove depth 6mm disc width 29mm groove width 10mm overall width 29mm plastic DL 30-40 drive shaft		



1

Part No.	691229 ¹	Ref. No.	DLX30012
description	V-belt pulley disc ø 75mm double shaft intake ø 13mm 14 groove depth 6mm disc width 29mm groove width 10mm overall width 32mm plastic DL 30-40 motor		

¹double

pinions

rear mounting



1

Part No.	694908	Ref. No.	DLX30043
description	pinion ø 47mm H 34mm mounting pos. rear ID ø 25mm edition since year of construction 2014		

front mounting



1

Part No.	694261	Ref. No.	DLX30036
description	pinion ø 47mm teeth 19 plastic H 34mm shaft ø 17mm		

springs



1

Part No.	693920	Ref. No.	DLX30033
description	spring for pinion ø 49mm thickness 1.5mm Qty 2 pcs		

transmission technology and ball bearings

ball bearings

deep-groove ball bearings 2RS



1

Part No.	523551	Ref. No.	C60032RS
description	deep-groove ball bearing type 6003-2RS shaft ø 17mm ED ø 35mm W 10mm with sealing discs deep-groove ball bearing DIN 625-1		



drive belts

round belts

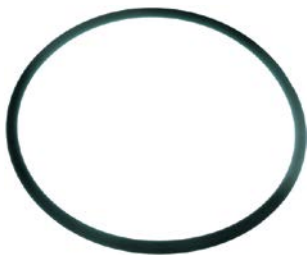

1

Part No.	691231	Ref. No.	DL030019
description	round belt ø 8mm L 640mm		

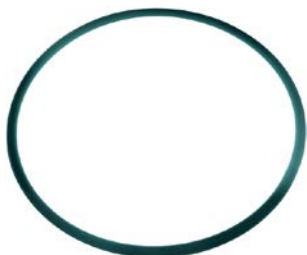

1

Part No.	691232	Ref. No.	DL030014
description	round belt ø 8mm L 730mm		

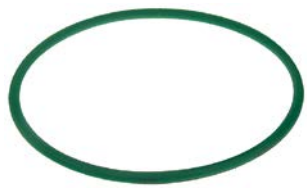

1

Part No.	694259	Ref. No.	DL040019
description	round belt ø 8mm L 750mm mounting pos. lower		

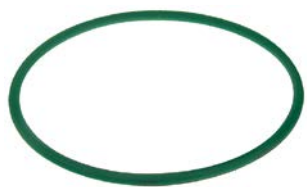

1

Part No.	694260	Ref. No.	DL040014
description	round belt ø 8mm L 933mm mounting pos. upper		

chains

roller chains 06B-1 single



1

Part No.	697127	Ref. No.	CA 3/8(42anelli-IM18T) IMX12022
description	roller chain DIN/ISO 06 B-1 splitting 3/8" / 9.525mm links 42 internal width 5.72mm rollerø 6.35mm single		

springs

torsion springs



1

Part No.	694241	Ref. No.	DLX30027
description	spring ømm L2 80mm mounting pos. front wire gauge ø 2mm DL 30-40 L1mm Qty 1 pcs		



1

Part No.	694240	Ref. No.	DLX30024
description	spring ømm L2 80mm mounting pos. rear wire gauge ø 2mm DL 30-40 L1mm Qty 1 pcs		

fastening material

fasteners

retaining rings

DIN 471



1

Part No.	504519	Ref. No.	051D1700
description	retaining ring shaft ø 17mm thickness 1mm SS DIN 471		

roll pins



1

Part No.	691637	Ref. No.	10303020
description	roll pin ø 3mm L 20mm		

GASTROPARTS.COM

