



**GASTROPARTS**

# LAVINOX

- [EN]** Equipment
- [DE]** Geräte
- [ES]** Aparatos
- [FR]** Équipement
- [IT]** Attrezzature
- [PL]** Urządzenia
- [RU]** Оборудование

✉ [gastroparts@gastroparts.com](mailto:gastroparts@gastroparts.com)

☎ +48 56 657 00 66

📘 [fb.com/gastroparts.global](https://fb.com/gastroparts.global)

**GASTROPARTS.COM**





## heating elements

### quartz heating elements

1			
<b>Part No.</b>	359630	<b>Ref. No.</b>	0661301000
<b>description</b>	infrared lamp 230V 500W L 490mm connection M4 ø 12mm		

### coil heating elements



1			
<b>Part No.</b>	418593	<b>Ref. No.</b>	0617303100
<b>description</b>	heating element 1200W 230V L 305mm W 50mm H 25mm tube ø 8.5mm thread M12x1.25 connection male faston 6.3mm connection length 30mm dry heating element heating circuits 1		



### heating elements for convection

1			
<b>Part No.</b>	418887	<b>Ref. No.</b>	0617301601
<b>description</b>	heating element 2400W 240V heating circuits 1 ID ø 180mm ED ø 192mm L 208mm H 33mm L1 10mm W1 30mm H1 5mm H2 27mm flange length 100mm flange width 22mm hole distance 86mm connection male faston 6.3mm connection length 36mm tube ø 6.3mm convection heating element mounting thread M4 rectangular flange heated cabinet		

## switches and momentary switches

### rocker/momentary rocker switches

30x22mm			
1			
<b>Part No.</b>	301003	<b>Ref. No.</b>	0641303900
<b>description</b>	rocker switch mounting measurements 30x22mm green 2NO 250V 16A illuminated 0-I connection male faston 6.3mm ambient temperature max. 125/55°C protection IP65		
<b>accessories for</b>	301003		
	<b>Part No.</b>	301036	<b>Ref. No.</b> —
	protective cover internal size 30x22mm for rocker switch mounting measurementsmm		

labelled			
1			
<b>Part No.</b>	300125	<b>Ref. No.</b>	0660800901
<b>description</b>	rocker switch mounting measurements 30x22mm green 2NO 230V 16A 0-I connection male faston 6.3mm ambient temperature max. 125/55°C protection IP65 with cover cap		
<b>accessories for</b>	300125		
	<b>Part No.</b>	301036	<b>Ref. No.</b> —
	protective cover internal size 30x22mm for rocker switch mounting measurementsmm		

## relays

### power relays

#### with bracket mounting

1			
<b>Part No.</b>	380139	<b>Ref. No.</b>	0648301900
<b>description</b>	power relays FINDER 230VAC 16A 2CO connection F6.3 bracket mounting dimensions 68x38.2x35.8mm manuf. no. 62.82.8.230.0000		

## electronic controllers

### EVCO - EVERY CONTROL

#### universal controllers

##### built-in version





1			
<b>Part No.</b>	378293	<b>Ref. No.</b>	0646305702
<b>description</b>	electronic controller EVCO mounting measurements 71x29mm 230V voltage AC NTC relay outputs 1 -99 up to +150°C display 4 digits 16A default setting +50 up to +70°C type EVK401N7VHXX01		
<b>accessories for</b>	378293		
	<b>Part No.</b>	378261	<b>Ref. No.</b> —
	temperature probe NTC 10kOhm cable thermoplastic probe -40 up to +110°C cable -40 up to +110°C probe ø6x35mm cable length 3m without screw connection 2-wire		
	<b>Part No.</b>	379057	<b>Ref. No.</b> —
	temperature probe NTC 10kOhm cable PVC probe -20 up to +80°C cable -10 up to 100°C probe ø6x25mm cable length 3m 2-wire		
	<b>Part No.</b>	379160	<b>Ref. No.</b> 0646305800
	temperature probe NTC 10kOhm cable thermoplastic probe -40 up to +110°C cable -40 up to +110°C probe ø6x14mm cable length 1.5m without screw connection 2-wire		

Table continues overleaf



accessories for	378293		
Part No.	379161	Ref. No.	—
	temperature probe NTC 10kOhm cable thermoplastic probe -40 up to +110°C cable -40 up to +110°C probe ø6x14mm cable length 3m without screw connection 2-wire		
Part No.	379342	Ref. No.	—
	temperature probe NTC 10kOhm cable PVC probe -20 up to +80°C cable -10 up to 100°C probe ø6x25mm cable length 1.5m 2-wire protection IP67		
Part No.	379343	Ref. No.	—
	temperature probe NTC 10kOhm cable silicone probe -40 up to +110°C cable -50 up to +180°C probe ø6x40mm cable length 3m 2-wire		
Part No.	379458	Ref. No.	—
	temperature probe NTC 10kOhm cable silicone probe -40 up to +110°C cable -50 up to +180°C probe ø6x40mm cable length 1.5m without screw connection 2-wire		
Part No.	379784	Ref. No.	—
	temperature probe NTC 2kOhm cable thermoplastic probe -40 up to +110°C cable -40 up to +110°C probe ø6x35mm cable length 2m without screw connection 2-wire resistor 2kOhm		
Part No.	379860	Ref. No.	—
	temperature probe NTC 10kOhm cable PVC probe -20 up to +80°C cable -10 up to 100°C probe ø6x40mm cable length 1.5m without screw connection 2-wire		

## probes

### universal probes

#### temperature probes



Part No.	379160	Ref. No.	0646305800
<b>description</b>	temperature probe NTC 10kOhm cable thermoplastic probe -40 up to +110°C cable -40 up to +110°C probe ø6x14mm cable length 1.5m without screw connection 2-wire		

## fans

### cross flow fans

#### COPREL

#### with standard coil



Part No.	601102	Ref. No.	682301800
<b>description</b>	cross flow fan TFL 45 roller ø 45mm roller length 300mm motor position left 230V/50Hz 35W refrigeration bearing rubber connection male faston 6.3mm airflow 268m³/h -10 up to +60°C 230V 50Hz		

## hot air fans

### miscellaneous



1

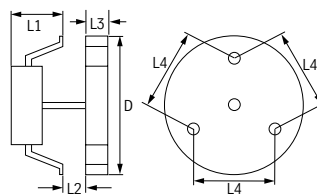

Part No.	601011	Ref. No.	0682300800
<b>description</b>	hot air fan 220-240V 40W 50/60Hz L1 65mm L2 15mm L3 25mm L4 87mm fan wheel ø 150mm FIME type C25R8023CLH		
<b>accessories for</b>	601011		
	Part No.	550879	Ref. No. —
	insulation ø 130mm thickness 3mm hole ø 20mm for hot air fan		
	Part No.	601260	Ref. No. —
	nut thread M6L IT for hot air fan		

## electric accessories

### terminals

#### porcelain clamps



1

Part No.	555001	Ref. No.	0639803201
<b>description</b>	porcelain terminal block 2-pole 6mm² max. 30A max 450V L 26mm W 24mm H 20mm mounting distancemm Qty 1 pcs		



## equipment-specific units

### for sliding doors

#### miscellaneous



1

<b>Part No.</b>	690570	<b>Ref. No.</b>	0140403100
<b>description</b>	rubber pad		

## hinges

### piano hinges

#### producer-specific

#### COOKMAX



1

<b>Part No.</b>	701171	<b>Ref. No.</b>	0511304900
<b>description</b>	hinge W 31mm mounting distance 30mm thickness 1mm total length 40mm set		

#### LAVINOX



1

<b>Part No.</b>	701171	<b>Ref. No.</b>	0511304900
<b>description</b>	hinge W 31mm mounting distance 30mm thickness 1mm total length 40mm set		

#### miscellaneous



1

<b>Part No.</b>	690000	<b>Ref. No.</b>	0511304200
<b>description</b>	hinge		

## pullouts

### drawer slides



1

<b>Part No.</b>	696495	<b>Ref. No.</b>	0830349500
<b>description</b>	telescopic slide pair L 500mm W 13mm H 32mm		



1

<b>Part No.</b>	696494	<b>Ref. No.</b>	0830348600
<b>description</b>	telescopic slide pair L 600mm W 13mm H 32mm		

### rollers

#### roller with holder



1

<b>Part No.</b>	690713	<b>Ref. No.</b>	0855358100
<b>description</b>	roller rollerø 22mm B1 6mm with holder SS/brass mounting pos. right door (right) bearing ball bearing Qty 1 pcs H 11mm L 64mm mounting distance 38/50mm		

**accessories for** 690713



<b>Part No.</b>	690570	<b>Ref. No.</b>	0140403100
<b>description</b>	rubber pad		



1

<b>Part No.</b>	690568	<b>Ref. No.</b>	0855320600
<b>description</b>	roller rollerø 22mm B1 6mm with holder SS/Nylon bearing ball bearing Qty 1 pcs H 12mm L 64mm mounting distance 38/50mm		

**accessories for** 690568



<b>Part No.</b>	690570	<b>Ref. No.</b>	0140403100
<b>description</b>	rubber pad		





1

<b>Part No.</b>	690569	<b>Ref. No.</b>	0855309801
<b>description</b>	roller rollerø 22mm B1 6mm with holder SS/Nylon mounting pos. at the back left bearing ball bearing Qty 1 pcs L 63mm mounting distance 38/50mm		



1

<b>Part No.</b>	690567	<b>Ref. No.</b>	0855309701
<b>description</b>	roller rollerø 22mm B1 6mm with holder SS/Nylon mounting pos. left door bearing ball bearing Qty 1 pcs H 12mm L 64mm mounting distance 38/50mm		



1

<b>Part No.</b>	690711	<b>Ref. No.</b>	0855309601
<b>description</b>	roller rollerø 22mm B1 6mm with holder SS/Nylon mounting pos. right door (left) bearing ball bearing Qty 1 pcs H 11mm L 63mm mounting distance 38/50mm		

accessories



1

<b>Part No.</b>	690570	<b>Ref. No.</b>	0140403100
<b>description</b>	rubber pad		

## equipment feet and end caps

### equipment feet

#### with screw mounting



1

<b>Part No.</b>	701172	<b>Ref. No.</b>	0805318400
<b>description</b>	equipment foot tube ø 52mm thread M10 thread L 18mm H 140/195mm SS size 2" Qty 1 pcs		

## bullet feet

### plastic/SS



1

<b>Part No.</b>	700869	<b>Ref. No.</b>	0805324100
<b>description</b>	equipment foot pipe type 40x40 thickness 1-1.2mm H 23-92mm plastic/SS Qty 1 pcs		

## DERBY RUOTE

### with fixing plate

#### chrome-plated steel



1

<b>Part No.</b>	701173	<b>Ref. No.</b>	0961300001
<b>description</b>	swivel castor ø 125mm plate fixing housing chrome-plated sheet steel plate size 95x70mm hole distance 50x70mm capacity 80kg bearing slide bearing wheel body polypropylene tread TPE tyres H 162mm wheel width 30mm Qty 1 pcs		



1

<b>Part No.</b>	701174	<b>Ref. No.</b>	0961300101
<b>description</b>			

## shelves and shelf rails

### shelf rails and supports

#### producer-specific



1

<b>Part No.</b>	690626	<b>Ref. No.</b>	0531306100
<b>description</b>	shelf support L 32mm W 14mm H 20mm		



## drain systems and wash basins

### standpipes

producer-specific

LAVINOX



1

<b>Part No.</b>	515133	<b>Ref. No.</b>	0830318600
<b>description</b>	drain fitting size 1½" usable heightmm overall heightmm SS		
<b>accessories for</b>	515133		
	<b>Part No.</b>	515134	<b>Ref. No.</b> 0515373900
	standpipe size 1½" usable height 225mm overall height 250mm ED ø 40mm SS		



1

<b>Part No.</b>	515134	<b>Ref. No.</b>	0515373900
<b>description</b>	standpipe size 1½" usable height 225mm overall height 250mm ED ø 40mm SS		
<b>accessories for</b>	515133		
	<b>Part No.</b>	515133	<b>Ref. No.</b> 0830318600
	drain fitting size 1½" usable heightmm overall heightmm SS		

**GASTRO**PARTS.COM

