



GASTROPARTS

Hupfer

- [EN]** Equipment
- [DE]** Geräte
- [ES]** Aparatos
- [FR]** Équipement
- [IT]** Attrezzature
- [PL]** Urządzenia
- [RU]** Оборудование

✉ gastroparts@gastroparts.com

☎ +48 56 657 00 66

📘 fb.com/gastroparts.global

GASTROPARTS.COM







heating elements

heating elements for plate warmers

			
Part No.	418283	Ref. No.	014001122
description	heating element 1000W 230V thread L 530mm W 30mm H 116mm heating circuits 1 cable length 760mm dry heating element tube ø 8.5mm connection distance 22mm		

			
Part No.	418276	Ref. No.	0191010879
description	heating element 200W 230V L 400mm W 67mm heating circuits 1 connection male faston 6.3mm dry heating element tube ø 8.5mm plate dispenser connection distance 59mm		

			
Part No.	418277	Ref. No.	014510023
description	heating element 500W 230V thread L 480mm W 75mm heating circuits 1 connection male faston 6.3mm dry heating element tube ø 8.5mm connection length 20mm connection distance 69mm		

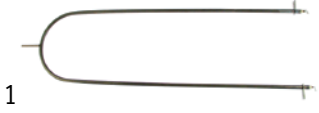
			
Part No.	418273	Ref. No.	014040068
description	heating element 900W 230V bracket mounting thread L 654mm W 183mm heating circuits 1 connection male faston 6.3mm dry heating element tube ø 8.5mm hole distance 213mm hole ø M4mm connection length 37mm lug length 36mm lug width 15mm		

heating elements for heated trolleys

			
Part No.	418283	Ref. No.	014001122
description	heating element 1000W 230V thread L 530mm W 30mm H 116mm heating circuits 1 cable length 760mm dry heating element tube ø 8.5mm connection distance 22mm		

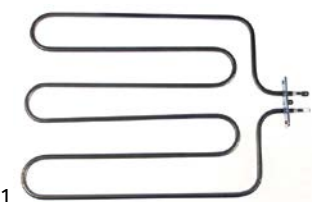

			
Part No.	418259	Ref. No.	014001112
description	heating element 450W 230V L 475mm W 181mm H 35mm connection male faston 6.3mm dry heating element L1 85mm L2 390mm W1 150mm W2 31mm rectangular flange tube ø 6.5mm heating circuits 1 hole distance 56mm flange length 70mm flange width 22mm hole ø 4mm		

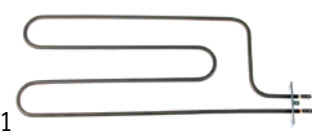
			
Part No.	418257	Ref. No.	014001104 014001104-UL
description	heating element 700W 230V L 345mm W 254mm connection male faston 6.3mm dry heating element L1 35mm L2 315mm W1 110mm W2 30mm rectangular flange tube ø 6.3mm heating circuits 1 hole distance 56/28mm flange length 70mm flange width 22mm hole ø M4mm connection length 35mm		
For models:	SPA0001		

			
Part No.	418258	Ref. No.	014001111
description	heating element 700W 230V L 446mm W 178mm connection male faston 6.3mm dry heating element L1 61mm L2 385mm W1 142mm W2 31mm rectangular flange tube ø 6.6mm heating circuits 1 hole distance 55mm flange length 70mm flange width 22mm hole ø M4mm connection length 35mm		

heating elements for convection

			
Part No.	418274	Ref. No.	014001107
description	heating element 1500W 230V heating circuits 1 ID ø 189mm ED ø 202mm L 225mm H 31mm L1 15mm W1 31mm H1 20mm H2 11mm flange length 70mm flange width 22mm hole distance 56mm connection male faston 6.3mm tube ø 6.5mm convection heating element hole ø 5mm rectangular flange		

			
Part No.	418275	Ref. No.	014041047-03
description	heating element 2000W 230V heating circuits 1 ID ø 194mm ED ø 207mm L 220mm H 32mm L1 5mm W1 31mm H1 10mm H2 22mm flange length 70mm flange width 22mm hole distance 56mm connection male faston 6.3mm tube ø 6.3mm dry heating element hole ø 5mm rectangular flange		
accessories for	418275		
		Part No.	510368
		Ref. No.	—
	gasket L 70mm W 23.5mm hole ø 5mm hole distance 56mm FIBER thickness 2mm for heating element		



thermostats

bi-metal thermostats

bi-metal thermostats



1

Part No.	375503	Ref. No.	014001202 0191095077
description	bi-metal thermostat hole distance 34mm switch-off temp. 91°C 2NC 2-poleA connection F6.3 Qty 1 pcs		

control and safety thermostats

EGO

control thermostats

55.13_ series



1

Part No.	375112	Ref. No.	014034027-01
description	thermostat t.max. 115°C temperature range 30-115°C 1-pole 1NO 16A probe ø 4mm probe L 124mm capillary pipe 1730mm capillary pipe isolated 800mm gland nut shaft L 15mm shaft position upper rotation 270°		



1

Part No.	375725	Ref. No.	014040011-01
description	thermostat t.max. 115°C temperature range 30-115°C 1-pole 1NO 16A probe ø 4mm probe L 124mm capillary pipe 830mm capillary pipe isolated 210mm gland nut shaft ø 6x4.6mm shaft L 15mm shaft position upper rotation 270°		



1

Part No.	375726	Ref. No.	014040228-01
description	thermostat t.max. 135°C temperature range 30-135°C 1-pole 1NO 16A probe ø 4mm probe L 124mm capillary pipe 830mm capillary pipe isolated 210mm gland nut shaft ø 6x4.6mm shaft L 15mm shaft position upper rotation 270°		



1

Part No.	375727	Ref. No.	014001214-02
description	thermostat t.max. 85°C temperature range 20-85°C 1-pole 1NO 16A probe ø 4mm probe L 124mm capillary pipe 870mm capillary pipe isolated 790mm gland nut shaft ø 6x4.6mm shaft L 15mm shaft position upper rotation 270°		



1

Part No.	375712	Ref. No.	014001213
description	thermostat t.max. 91°C temperature range 30-91°C 1-pole 1CO 16A probe ø 3.1mm probe L 201mm capillary pipe 1730mm capillary pipe isolated 210mm gland nut shaft ø 6x4.6mm shaft L 15mm shaft position upper rotation 270°		



switches and momentary switches

rocker/momentary rocker switches

30x22mm

labelled



1

Part No.	300125	Ref. No.	014001300
-----------------	--------	-----------------	-----------

description	rocker switch mounting measurements 30x22mm green 2NO 230V 16A 0-I connection male faston 6.3mm ambient temperature max. 125/55°C protection IP65 with cover cap
--------------------	--

accessories for 300125



Part No.	301036	Ref. No.	—
description	protective cover internal size 30x22mm for rocker switch mounting measurementsmm		

microswitches

pin-plunger actuated



1

Part No.	305004	Ref. No.	0191093679
-----------------	--------	-----------------	------------

description	microswitch with plunger 250V 16A 1NO/1NC connection male faston 6.3mm ambient temperature max. 85°C mounting distance 22mm type XPZ211 actuating force: 500g red stroke 8mm
--------------------	--

fans

hot air fans

ebm-papst



1

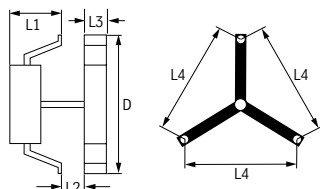

Part No.	601253	Ref. No.	014001013
-----------------	--------	-----------------	-----------

description	hot air fan 240V 30W L1 58mm L2 10mm L3 20mm L4 88mm fan wheel ø 150mm type R2K150-AC03-75 ebm-papst 1850rpm
--------------------	--

electric accessories

plugs - couplings - power sockets

appliance sockets/plugs

medium temperature appliances 120°C



1

Part No.	550706	Ref. No.	014510022
-----------------	--------	-----------------	-----------

description	medium temperature appliance plug C16 screw max 10A/250V T120 mounting distance 40mm hole ø 3.5mm thermoplastic
--------------------	---

cables

spiral cables



1

Part No.	550101	Ref. No.	014001081
-----------------	--------	-----------------	-----------

description	spiral cable plug type CEE7/7 type E+F 1.5mm ² 3-pole with plug L 500mm expansion 5:1 countries A/B/D/F/I orange t.max. 70°C
--------------------	---



1

Part No.	550071	Ref. No.	014001082
-----------------	--------	-----------------	-----------

description	spiral cable plug type CEE7/7 type E+F 1.5mm ² 3-pole with plug L 500mm expansion 5:1 countries A/D/I black
--------------------	--

knobs

producer-specific knobs

HUPFER



1

Part No.	111440	Ref. No.	014002170-01
-----------------	--------	-----------------	--------------

description	knob ø 54mm shaft ø 6x4.6mm shaft flat lower
--------------------	--

1

Part No.	111873	Ref. No.	014002118
description	knob switch zero mark ø 54mm shaft ø 6x4.6mm shaft flat lower black		

handles and hand wheels

miscellaneous



1

Part No.	690895	Ref. No.	014002100 014002101 0162592
description	handle mounting pos. left/right Qty 2 pcs		

pullouts

rollers

rollers

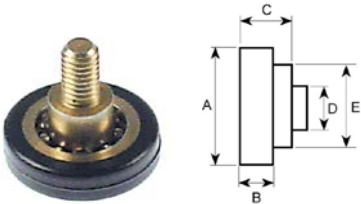

1

Part No.	690920	Ref. No.	014041030
description	roller rollerø 24mm B1 6mm A 24mm B 6mm C 11.6mm D M6mm E 10mm plastic bearing ball bearing with thread bolt thread M6		

TENTE

with fixing plate

plastic



1

Part No.	700306	Ref. No.	014000400
description	fixed castor ø 125mm plates fixing 95x70mm housing plastic plate size 95x70mm hole distance 75x50mm capacity 100kg bearing ball bearing wheel body polypropylene tread TPE tyres H 166mm wheel width 32mm -20 up to +60°C Qty 1 pcs		



1

Part No.	700305	Ref. No.	014000401
description	swivel castor ø 125mm plate fixing housing plastic plate size 95x70mm hole distance 75x50mm capacity 100kg bearing ball bearing wheel body polypropylene tread TPE tyres H 166mm wheel width 32mm -20 up to +60°C Qty 1 pcs		



1

Part No.	700304 ¹	Ref. No.	014000402
description	swivel castor with swivel brake ø 125mm plate fixing housing plastic plate size 95x70mm hole distance 75x50mm capacity 100kg bearing ball bearing wheel body polypropylene tread TPE tyres H 166mm wheel width 32mm -20 up to +60°C Qty 1 pcs		

¹with swivel brake

with spigot

plastic



1

Part No.	700302	Ref. No.	014000405 014000406
description	swivel castor ø 125mm spigot housing plastic capacity 100kg spigot height 62mm spigot-ø 18mm bearing ball bearing wheel body polypropylene tread TPE tyres H 162mm wheel width 32mm -20 up to +60°C Qty 1 pcs		



			
1			
Part No.	700303 ¹	Ref. No.	014000405 014000406
description	swivel castor with swivel brake ø 125mm spigot housing plastic capacity 100kg spigot hight 62mm spigot-ø 18mm bearing ball bearing wheel body polypropylene tread TPE tyres H 162mm wheel width 32mm -20 up to +60°C Qty 1 pcs		

¹with swivel brake

spare parts and accessories

sleeves

for square pipes



			
1			
Part No.	710065	Ref. No.	014002006
description	sleeve suitable for square pipes external size 22.5x22.5mm L 62mm polyamide ø 18mm		

miscellaneous

bumper wheels

			
1			
Part No.	700157	Ref. No.	014002111
description	bumper wheel ED ø 99mm ID ø 25x25mm H 19mm PVC grey		

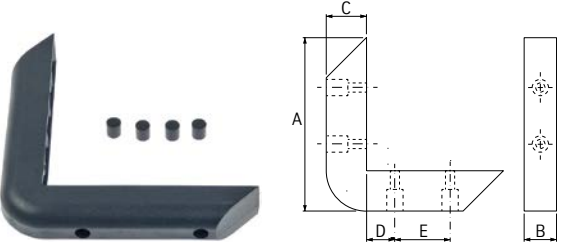
bumper angles

			
1			
Part No.	690908 ¹	Ref. No.	014002110
description	bumper angle outer length 180mm inner length 150mm W 30.5mm H 30mm mounting distance 80mm hole distance 27mm hole ø 5mm plastic black		
accessories for	690908		
	Part No.	Ref. No.	
	690896	0140026004	
	 plug for bumper angle ø 10mm L 11mm black Qty 16 pcs		

¹suitable plug 690896

			
1			
Part No.	690896	Ref. No.	0140026004
description	plug for bumper angle ø 10mm L 11mm black Qty 16 pcs		

baskets

fryer baskets

various

			
1			
Part No.	970157	Ref. No.	05.1606.2
description	fryer basket L1 295mm W1 200mm H1 115mm		

transmission technology and ball bearings

ball bearings

deep-groove ball bearings 2RS

			
1			
Part No.	523507	Ref. No.	014045014
description	deep-groove ball bearing type 6000-2RS shaft ø 10mm ED ø 26mm W 8mm with sealing discs deep-groove ball bearing DIN 625-1		

springs

tension springs

			
1			
Part No.	700517	Ref. No.	014040164
description	tension spring ø 11.8mm total length 145mm wire gauge ø 1.1mm		

			
1			
Part No.	700516	Ref. No.	014040101
description	tension spring ø 19.4mm total length 145mm wire gauge ø 1.6mm		

			
1			
Part No.	700518	Ref. No.	014004104
description	tension spring ø 25.5mm total length 150mm wire gauge ø 2mm		



			
Part No.	692208	Ref. No.	014055088
description	tension spring ø 27mm total length 148mm wire gauge ø 2.1mm stainless steel		

GASTROPARTS.COM

