



**GASTROPARTS**

# Hendi

- [EN]** Equipment
- [DE]** Geräte
- [ES]** Aparatos
- [FR]** Équipement
- [IT]** Attrezzature
- [PL]** Urządzenia
- [RU]** Оборудование

✉ [gastroparts@gastroparts.com](mailto:gastroparts@gastroparts.com)

☎ +48 56 657 00 66

📘 [fb.com/gastroparts.global](https://fb.com/gastroparts.global)

**GASTROPARTS.COM**





## heating elements

### heating elements for bain maries

|   |  |                 |        |
|---|--|-----------------|--------|
|  |  |                 |        |
| <b>Part No.</b>   | 420476   | <b>Ref. No.</b> | 900642 |
| <b>description</b>  | heating element 1200W 230V heating circuits 1 L 405mm W 150mm connection M4 connection distance 145mm tube ø 7mm |                 |        |

### heating elements for contact grills

|   |  |                 |        |
|---|--|-----------------|--------|
|  |  |                 |        |
| <b>Part No.</b>   | 419161   | <b>Ref. No.</b> | 912171 |
| <b>description</b>  | heating element 1100W 415V L 180mm W 180mm H 40mm tube ø 6.5mm connection M4 |                 |        |

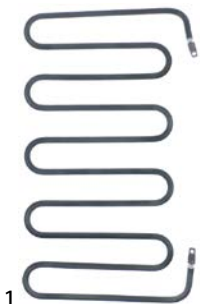
|  |   |                 |        |
|--|---|-----------------|--------|
|  |   |                 |        |
| <b>Part No.</b>  | 419002  | <b>Ref. No.</b> | 902028 |
| <b>description</b>   | heating element 1400W 230V heating circuits 1 L 175mm W 305mm H 20mm W1 40mm W2 325mm tube ø 6.3mm windings 5 |                 |        |

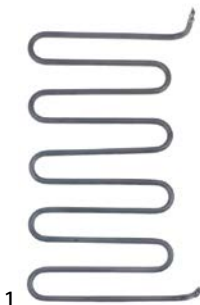
|   |   |                 |        |
|---|---|-----------------|--------|
|  |   |                 |        |
| <b>Part No.</b>   | 419003  | <b>Ref. No.</b> | 902035 |
| <b>description</b>  | heating element 1550W 240V L 175mm W 305mm H 40mm tube ø 6.3mm connection M4 windings 5 |                 |        |

|  |   |                 |        |
|--|---|-----------------|--------|
|  |   |                 |        |
| <b>Part No.</b>  | 419160  | <b>Ref. No.</b> | 912140 |
| <b>description</b>   | heating element 900W 400V L 170mm W 180mm H 15mm W1 40mm W2 100mm tube ø 6.5mm windings 3 connection M4 |                 |        |

## thermostats

### bi-metal thermostats

#### safety bi-metal thermostats

|   |   |                 |        |
|---|---|-----------------|--------|
|  |   |                 |        |
| <b>Part No.</b>   | 390708  | <b>Ref. No.</b> | 902004 |
| <b>description</b>  | bi-metal safety thermostat hole distance 23.5mm switch-off temp. 180°C 1NC 1-pole 16A connection M3 mounting ø 15mm |                 |        |

#### bi-metal thermostats

|   |   |                 |        |
|---|---|-----------------|--------|
|  |   |                 |        |
| <b>Part No.</b>   | 390886  | <b>Ref. No.</b> | 923153 |
| <b>description</b>  | bi-metal thermostat hole distance 24mm switch-off temp. 210°C 1NC 1-pole 16A 250V connection F6.3 2 hole fixing Qty 1 pcs |                 |        |

### control and safety thermostats

#### EGO

#### control thermostats

#### 55.13\_ series

|  |  |                 |        |
|--|--|-----------------|--------|
|  |  |                 |        |
| <b>Part No.</b>  | 390885   | <b>Ref. No.</b> | 205228 |
| <b>description</b>   | thermostat t.max. 190°C temperature range 0-190°C 1-pole 1NO 16A probe ø 6mm probe L 115mm capillary pipe 550mm capillary pipe isolated 260mm gland nut shaft ø 6x4.6mm shaft L 20mm shaft position 135° rotation 270° |                 |        |



E.G.O



|                    |  |                 |        |
|--------------------|--|-----------------|--------|
| <b>Part No.</b>    | 390884   | <b>Ref. No.</b> | 923092 |
| <b>description</b> | thermostat t.max. 250°C temperature range 50-250°C 1-pole 1NO 16A probe ø 6mm probe L 62mm capillary pipe 1450mm capillary pipe isolatedmm gland nut shaft ø 6x4.6mm shaft L 16mm shaft position upper rotation 270° probe material SS |                 |        |

E.G.O



|                    |  |                 |        |
|--------------------|--|-----------------|--------|
| <b>Part No.</b>    | 375505   | <b>Ref. No.</b> | 902011 |
| <b>description</b> | thermostat t.max. 320°C temperature range 50-320°C 1-pole 1NO 16A probe ø 3mm probe L 160mm capillary pipe 870mm capillary pipe isolatedmm gland nut shaft ø 6x4.6mm shaft L 23mm shaft position upper rotation 270° |                 |        |

## switches and momentary switches

### rocker/momentary rocker switches

30x22mm



|                    |  |                 |        |
|--------------------|--|-----------------|--------|
| <b>Part No.</b>    | 347791   | <b>Ref. No.</b> | 205426 |
| <b>description</b> | rocker switch mounting measurements 30x22mm green 2NO 230V 20A illuminated 0-1 connection male faston 6.3mm ambient temperature max. 125/55°C protection IP65 with rubber collar |                 |        |
| <b>For models:</b> | 221204   |                 |        |

## cam switches

### 4 operating positions

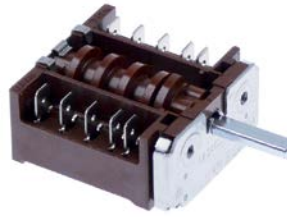

|                    |  |                 |        |
|--------------------|--|-----------------|--------|
| <b>Part No.</b>    | 300243   | <b>Ref. No.</b> | 912102 |
| <b>description</b> | cam switch 2 operating positions sequence 0-1 shaft ø 6x4.6mm shaft L 23mm connection male faston 6.3mm 4-pole |                 |        |

## lamps

### indicator lights

#### indicator lights (complete)

ø12mm

with plug-in socket



|                    |  |                 |        |
|--------------------|--|-----------------|--------|
| <b>Part No.</b>    | 357110   | <b>Ref. No.</b> | 912119 |
| <b>description</b> | indicator light ø 12mm green 400V connection male faston 6.3mm temp.-resist. 100°C |                 |        |



|                    |   |                 |        |
|--------------------|---|-----------------|--------|
| <b>Part No.</b>    | 360509  | <b>Ref. No.</b> | 912003 |
| <b>description</b> | indicator light ø 12mm yellow 230V connection male faston 6.3mm thermometer |                 |        |



|                    |   |                 |        |
|--------------------|---|-----------------|--------|
| <b>Part No.</b>    | 357111  | <b>Ref. No.</b> | 912126 |
| <b>description</b> | indicator light ø 12mm yellow 400V connection male faston 6.3mm thermometer |                 |        |



## motors

### motors

#### for citrus juicers

|   |   |                 |                     |
|---|---|-----------------|---------------------|
|  |   |                 |                     |
| 1   |   |                 |                     |
| <b>Part No.</b>   | 501426  | <b>Ref. No.</b> | 900956<br>JR2004-MS |
| <b>description</b>  | motor for citrus juicers 180W 230-240V 50Hz shaft ø 8mm shaft length 40mm type RCJ298252 0.18kW |                 |                     |
| <b>For models:</b>  | 221204  |                 |                     |

## fuses

### thermal fuses

|   |  |                 |        |
|---|--|-----------------|--------|
|  |  |                 |        |
| 1   |  |                 |        |
| <b>Part No.</b>   | 358139   | <b>Ref. No.</b> | 923160 |
| <b>description</b>  | thermal fuse switch-off temp. 142°C nominal 15A rated 250V Qty 1 pcs |                 |        |

## electric accessories

### cables

#### cable harnesses

|   |               |                 |                  |
|---|---------------|-----------------|------------------|
|  |               |                 |                  |
| 1   |               |                 |                  |
| <b>Part No.</b>   | 699172        | <b>Ref. No.</b> | 912089<br>917089 |
| <b>description</b>  | cable harness |                 |                  |

|   |               |                 |        |
|---|---------------|-----------------|--------|
|  |               |                 |        |
| 1   |               |                 |        |
| <b>Part No.</b>   | 699173        | <b>Ref. No.</b> | 912188 |
| <b>description</b>  | cable harness |                 |        |

### terminals

#### connection terminals with screw connection

|   |  |                 |        |
|---|--|-----------------|--------|
|  |  |                 |        |
| 1   |  |                 |        |
| <b>Part No.</b>   | 551109   | <b>Ref. No.</b> | 912041 |
| <b>description</b>  | connecting cable 4-pole max. 15A max 500V connection screw temp.-resist. 150°C |                 |        |

## equipment-specific units

### for cutters

#### blades

#### blades

#### blades smooth

|  |   |                 |        |
|--|---|-----------------|--------|
|  |   |                 |        |
| 1  |   |                 |        |
| <b>Part No.</b>  | 696558  | <b>Ref. No.</b> | 919613 |
| <b>description</b>   | knife L 140mm mounting distance 23mm threaded thickness 2mm |                 |        |

### for citrus juicers

#### spillage trays

|  |  |                 |        |
|--|--|-----------------|--------|
|  |  |                 |        |
| 1  |  |                 |        |
| <b>Part No.</b>  | 696502   | <b>Ref. No.</b> | 900963 |
| <b>description</b>   | drain tray for citrus juicers ø 175mm hole ø 42mm H 110mm SS |                 |        |
| <b>For models:</b>   | 221204   |                 |        |

#### gaskets

|   |   |                 |        |
|---|---|-----------------|--------|
|  |   |                 |        |
| 1   |   |                 |        |
| <b>Part No.</b>   | 532647  | <b>Ref. No.</b> | 900970 |
| <b>description</b>  | O-ring EPDM thickness 1.8mm ID ø 11.8mm Qty 1 pcs |                 |        |
| <b>For models:</b>  | 221204  |                 |        |

|  |                             |                 |        |
|--|-----------------------------|-----------------|--------|
|  |                             |                 |        |
| 1  |                             |                 |        |
| <b>Part No.</b>  | 511953                      | <b>Ref. No.</b> | 900871 |
| <b>description</b>   | seal kit for citrus juicers |                 |        |
| <b>For models:</b>   | 221204                      |                 |        |



## motors



1

|                    |   |                 |                     |
|--------------------|---|-----------------|---------------------|
| <b>Part No.</b>    | 501426  | <b>Ref. No.</b> | 900956<br>JR2004-MS |
| <b>description</b> | motor for citrus juicers 180W 230-240V 50Hz shaft ø 8mm shaft length 40mm type RCJ298252 0.18kW |                 |                     |
| <b>For models:</b> | 221204  |                 |                     |

## juicer insert



1

|                    |  |                 |        |
|--------------------|--|-----------------|--------|
| <b>Part No.</b>    | 650168   | <b>Ref. No.</b> | 900901 |
| <b>description</b> | filter for citrus juicers ø 155mm H 23mm plastic |                 |        |
| <b>For models:</b> | 221204   |                 |        |



1

|                    |  |                 |        |
|--------------------|--|-----------------|--------|
| <b>Part No.</b>    | 650167   | <b>Ref. No.</b> | 221266 |
| <b>description</b> | juicer insert set for citrus juicers ø 57/62/79mm H 45/50/55mm plastic |                 |        |
| <b>For models:</b> | 221204   |                 |        |

## spindles



1

|                    |   |                 |        |
|--------------------|---|-----------------|--------|
| <b>Part No.</b>    | 650170  | <b>Ref. No.</b> | 900895 |
| <b>description</b> | spindle L 48mm square thread M8x1.25 for citrus juicers WS 12 |                 |        |
| <b>For models:</b> | 221204  |                 |        |

## miscellaneous



1

|                    |   |                 |        |
|--------------------|---|-----------------|--------|
| <b>Part No.</b>    | 650171                                    | <b>Ref. No.</b> | 900925 |
| <b>description</b> | cover for spindle ø 44mm H 18mm aluminium |                 |        |
| <b>For models:</b> | 221204                                    |                 |        |



1

|                    |  |                 |        |
|--------------------|--|-----------------|--------|
| <b>Part No.</b>    | 650169   | <b>Ref. No.</b> | 221242 |
| <b>description</b> | drip tray for citrus juicers ø 79mm H 20mm plastic black |                 |        |
| <b>For models:</b> | 221204   |                 |        |

## for grills

## sumps



1

|                    |  |                 |        |
|--------------------|--|-----------------|--------|
| <b>Part No.</b>    | 692237                                       | <b>Ref. No.</b> | 263990 |
| <b>description</b> | grease collecting tray L 357mm W 37mm H 29mm |                 |        |



1

|                    |  |                 |        |
|--------------------|--|-----------------|--------|
| <b>Part No.</b>    | 692238                                       | <b>Ref. No.</b> | 263983 |
| <b>description</b> | grease collecting tray L 497mm W 37mm H 29mm |                 |        |

## for panini grill

## guiding pieces

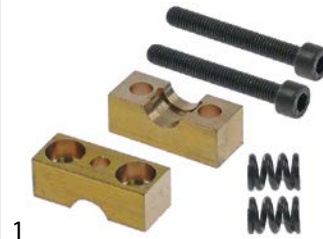

1

|                    |   |                 |        |
|--------------------|---|-----------------|--------|
| <b>Part No.</b>    | 698565  | <b>Ref. No.</b> | 902097 |
| <b>description</b> | shaft bearing mounting pos. rear L 35mm W 14mm H 12.5mm |                 |        |

## for contact grills

## miscellaneous



1

|                    |                           |                 |                  |
|--------------------|---------------------------|-----------------|------------------|
| <b>Part No.</b>    | 692241                    | <b>Ref. No.</b> | 902195<br>912195 |
| <b>description</b> | spindle for contact grill |                 |                  |

1

|                    |  |                 |        |
|--------------------|--|-----------------|--------|
| <b>Part No.</b>    | 692239                                   | <b>Ref. No.</b> | 902226 |
| <b>description</b> | spindle for contact grill L 404mm ø 12mm |                 |        |

## knobs

### producer-specific knobs

HENDI



1

|                    |   |                 |        |
|--------------------|---|-----------------|--------|
| <b>Part No.</b>    | 112870  | <b>Ref. No.</b> | 904411 |
| <b>description</b> | knob t.max. 300°C 50-300°C ø 58mm shaft ø 6x4.6mm shaft flat left |                 |        |



1

|                    |   |                 |                    |
|--------------------|---|-----------------|--------------------|
| <b>Part No.</b>    | 112674  | <b>Ref. No.</b> | 904411 old version |
| <b>description</b> | knob thermostat t.max. 300°C 50-300°C ø 58mm shaft ø 6x4.6mm shaft flat lower |                 |                    |

## handles and hand wheels

### folding grill handles



1

|                    |   |                 |        |
|--------------------|---|-----------------|--------|
| <b>Part No.</b>    | 692149  | <b>Ref. No.</b> | 902264 |
| <b>description</b> | handle L 155mm ø 30mm seat ø 10mm for contact grill |                 |        |

## equipment feet and end caps

### screw-in feet



1

|                    |  |                 |        |
|--------------------|--|-----------------|--------|
| <b>Part No.</b>    | 701230   | <b>Ref. No.</b> | 900888 |
| <b>description</b> | equipment feet kit thread M5 thread L 10mm ø 22mm H 12mm rubber WS Qty 4 pcs bore ø 5/10mm |                 |        |
| <b>For models:</b> | 221204   |                 |        |



1

|                    |  |                 |        |
|--------------------|--|-----------------|--------|
| <b>Part No.</b>    | 802048   | <b>Ref. No.</b> | 912058 |
| <b>description</b> | equipment foot thread M6 thread L 14mm ø 30mm H 16mm Qty 4 pcs |                 |        |

## gaskets

### gaskets for heated units

#### door seals with fixing hook



1

|                    |   |                 |        |
|--------------------|---|-----------------|--------|
| <b>Part No.</b>    | 900394  | <b>Ref. No.</b> | 225332 |
| <b>description</b> | oven gasket L 370mm W 640mm 6 hooks external size |                 |        |

## O-rings

### EPDM



1

|                    |   |                 |        |
|--------------------|---|-----------------|--------|
| <b>Part No.</b>    | 532647  | <b>Ref. No.</b> | 900970 |
| <b>description</b> | O-ring EPDM thickness 1.8mm ID ø 11.8mm Qty 1 pcs |                 |        |
| <b>For models:</b> | 221204  |                 |        |



## shaft gaskets

## miscellaneous



|                 |        |                 |        |
|-----------------|--------|-----------------|--------|
| <b>Part No.</b> | 511953 | <b>Ref. No.</b> | 900871 |
|-----------------|--------|-----------------|--------|

|                    |                             |
|--------------------|-----------------------------|
| <b>description</b> | seal kit for citrus juicers |
|--------------------|-----------------------------|

|                    |        |
|--------------------|--------|
| <b>For models:</b> | 221204 |
|--------------------|--------|

## springs

## torsion springs



|                 |        |                 |        |
|-----------------|--------|-----------------|--------|
| <b>Part No.</b> | 700569 | <b>Ref. No.</b> | 901908 |
|-----------------|--------|-----------------|--------|

|                    |   |
|--------------------|---|
| <b>description</b> | torsion spring $\varnothing$ 21.5mm L2 40mm wire gauge $\varnothing$ 3.3mm L1 100mm L3 45mm |
|--------------------|---|

## fastening material

## fasteners

## roll pins



|                 |        |                 |        |
|-----------------|--------|-----------------|--------|
| <b>Part No.</b> | 692236 | <b>Ref. No.</b> | 902240 |
|-----------------|--------|-----------------|--------|

|                    |                                   |
|--------------------|-----------------------------------|
| <b>description</b> | roll pin $\varnothing$ 4mm L 40mm |
|--------------------|-----------------------------------|

## consumables

## fuses

## thermal fuses



|                 |        |                 |        |
|-----------------|--------|-----------------|--------|
| <b>Part No.</b> | 358139 | <b>Ref. No.</b> | 923160 |
|-----------------|--------|-----------------|--------|

|                    |  |
|--------------------|--|
| <b>description</b> | thermal fuse switch-off temp. 142°C nominal 15A rated 250V Qty 1 pcs |
|--------------------|--|

**GASTRO**PARTS.COM

