



**GASTROPARTS**

# Fryland

- [EN]** Equipment
- [DE]** Geräte
- [ES]** Aparatos
- [FR]** Équipement
- [IT]** Attrezzature
- [PL]** Urządzenia
- [RU]** Оборудование

✉ [gastroparts@gastroparts.com](mailto:gastroparts@gastroparts.com)

☎ +48 56 657 00 66

📘 [fb.com/gastroparts.global](https://fb.com/gastroparts.global)

**GASTROPARTS.COM**























gas thermostats

SIT

710 Minisit series



|   |   |                 |                   |
|---|---|-----------------|-------------------|
| <b>Part No.</b>   | 101135  | <b>Ref. No.</b> | 03137             |
| <b>description</b>  | gas thermostat SIT type MINISIT 710 t.max. 190°C 110-190°C gas inlet 1/2" gas outlet 3/8" thermocouple connection M9x1 pilot connection M10x1 probe ø 6mm probe L 102mm capillary pipe 1050mm probe type type A3 pressure controller no pressure regulator/mbar gland nut |                 |                   |
| <b>For models:</b>  | Lt15+15g-ce   |                 |                   |
| <b>spare parts for</b>  | 101135  |                 |                   |
|    | <b>Part No.</b>   | 101053          | <b>Ref. No.</b> — |
|   | magnet unit T1: M9x1 T2: M24x1 L 45mm ø 17mm suitable for Minisit   |                 |                   |
|    | <b>Part No.</b>   | 102118          | <b>Ref. No.</b> — |
|   | probe 110-190°C probe ø 6mm probe L 102mm capillary pipe 1050mm t.max. 190°C fryer probe type type A3 suitable for MINISIT 710  |                 |                   |
| <b>accessories for</b>  | 101135  |                 |                   |
|  | <b>Part No.</b>   | 100809          | <b>Ref. No.</b> — |
|   | O-ring EPDM thickness 2mm ID ø 21mm Qty 1 pcs   |                 |                   |
|  | <b>Part No.</b>   | 100820          | <b>Ref. No.</b> — |
|   | gland duct ET M14x1.5 IT M10x0.75 probe ø max. 6.5mm WS 22  |                 |                   |
|  | <b>Part No.</b>   | 100904          | <b>Ref. No.</b> — |
|   | locking screw M10x1 for pipe ø 4mm Qty 1 pcs  |                 |                   |
|  | <b>Part No.</b>   | 100905          | <b>Ref. No.</b> — |
|   | locking screw M10x1 for pipe ø 6mm Qty 1 pcs  |                 |                   |
|  | <b>Part No.</b>   | 101054          | <b>Ref. No.</b> — |
|   | magnet unit T1: M10x1 T2: M24x1 L 45mm ø 17mm suitable for Minisit  |                 |                   |
|  | <b>Part No.</b>   | 101136          | <b>Ref. No.</b> — |
|   | piezoelectric igniter suitable for Minisit with cover cap ømm connection F6.3x0.8   |                 |                   |
|  | <b>Part No.</b>   | 101137          | <b>Ref. No.</b> — |
|   | cover cap without piezoelectric igniter   |                 |                   |
|  | <b>Part No.</b>   | 101267          | <b>Ref. No.</b> — |
|   | reducer IT 3/8" ET 1/2" L 21mm  |                 |                   |
|  | <b>Part No.</b>   | 101268          | <b>Ref. No.</b> — |
|   | gas connection thread 3/8" angled with O-ring MINISIT 710   |                 |                   |
|  | <b>Part No.</b>   | 101269          | <b>Ref. No.</b> — |
|   | gas connection thread 1/2" angled with O-ring MINISIT 710   |                 |                   |
|  | <b>Part No.</b>   | 101270          | <b>Ref. No.</b> — |
|   | screw connection IT 3/8" ET 3/8" L 28mm   |                 |                   |

|   |  |        |                   |
|---|--|--------|-------------------|
| <b>accessories for</b>  | 101135   |        |                   |
|  | <b>Part No.</b>  | 101272 | <b>Ref. No.</b> — |
|   | screw connection IT 1/2" ET 3/8" L 57mm                              |        |                   |
|  | <b>Part No.</b>  | 101273 | <b>Ref. No.</b> — |
|   | olive for pipe ø 12mm L 9.5mm brass Qty 1 pcs suitable for universal |        |                   |
|  | <b>Part No.</b>  | 101274 | <b>Ref. No.</b> — |
|   | olive for pipe ø 16mm Qty 1 pcs                                      |        |                   |
|  | <b>Part No.</b>  | 101275 | <b>Ref. No.</b> — |
|   | union screw thread 1/2" for pipe ø 16mm Qty 1 pcs                    |        |                   |
|  | <b>Part No.</b>  | 101276 | <b>Ref. No.</b> — |
|   | union screw thread 3/8" tube ø 12mm Qty 1 pcs                        |        |                   |
|  | <b>Part No.</b>  | 110068 | <b>Ref. No.</b> — |
|   | knob suitable for Minisit ø 37mm                                     |        |                   |

ignition parts

pilot burners

SIT

100 series











|   |  |                 |                   |
|---|--|-----------------|-------------------|
| <b>Part No.</b>   | 107139   | <b>Ref. No.</b> | 03139             |
| <b>description</b>  | pilot burner SIT type 100 series 1 flame nozzle ø 0.2mm gas connectionmm |                 |                   |
| <b>For models:</b>  | Lt15+15g-ce  |                 |                   |
| <b>spare parts for</b>  | 107139   |                 |                   |
|  | <b>Part No.</b>  | 100854          | <b>Ref. No.</b> — |
|   | pilot burner bracket double  |                 |                   |
|  | <b>Part No.</b>  | 100885          | <b>Ref. No.</b> — |
|   | air mixing sleeve for pilot burner Qty 1 pcs                             |                 |                   |
|  | <b>Part No.</b>  | 107160          | <b>Ref. No.</b> — |
|   | pilot burner cap SIT 1 flame Hmm Lmm Qty 1 pcs                           |                 |                   |
| <b>accessories for</b>  | 107139   |                 |                   |
|  | <b>Part No.</b>  | 100904          | <b>Ref. No.</b> — |
|   | locking screw M10x1 for pipe ø 4mm Qty 1 pcs                             |                 |                   |
|  | <b>Part No.</b>  | 100905          | <b>Ref. No.</b> — |
|   | locking screw M10x1 for pipe ø 6mm Qty 1 pcs                             |                 |                   |
|  | <b>Part No.</b>  | 100998          | <b>Ref. No.</b> — |
|   | pilot burner bottom part nozzle ø 0.21mm suitable for 100 series         |                 |                   |
|  | <b>Part No.</b>  | 102110          | <b>Ref. No.</b> — |
|   | pilot tube copper pipe ø 4mm thickness 1mm L 3000mm                      |                 |                   |

Table continues overleaf









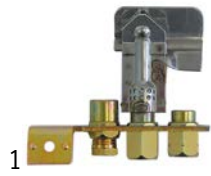









|   |   |        |          |   |
|---|---|--------|----------|---|
| <b>accessories for</b>  | 107139  |        |          |   |
|   | Part No.  | 102111 | Ref. No. | — |
|  | pilot tube copper pipe ø 6mm thickness 1mm L 3000mm |        |          |   |

## POLIDORO

### pilot burners





|   |  |                 |          |   |
|---|--|-----------------|----------|---|
| <b>Part No.</b>   | 100076   | <b>Ref. No.</b> | 03479    |   |
| <b>description</b>  | pilot burner POLIDORO 3 flames natural gas code 29.2 gas connection 6mm              |                 |          |   |
| <b>For models:</b>  | SC6FG  |                 |          |   |
| <b>spare parts for</b>  | 100076   |                 |          |   |
|    | Part No.   | 100907          | Ref. No. | — |
|   | screw connection thread M10x1 Qty 1 pcs type SEF 1 ømm for thermocouple              |                 |          |   |
| <b>accessories for</b>  | 100076   |                 |          |   |
|    | Part No.   | 100000          | Ref. No. | — |
|   | pilot burner nozzle POLIDORO LPG code 22 bore ø 0.22mm Qty 1 pcs                     |                 |          |   |
|   | Part No.   | 100208          | Ref. No. | — |
|   | pilot burner nozzle POLIDORO LPG code 20 bore ø 0.2mm Qty 1 pcs                      |                 |          |   |
|  | Part No.   | 100209          | Ref. No. | — |
|   | pilot burner nozzle POLIDORO natural gas code 40 bore ø 0.4mm Qty 1 pcs              |                 |          |   |
|  | Part No.   | 100701          | Ref. No. | — |
|   | ignition electrode connection M4 Qty 1 pcs   |                 |          |   |
|  | Part No.   | 100906          | Ref. No. | — |
|   | screw connection thread M10x1 for ignition electrode brass Qty 1 pcs WS 10           |                 |          |   |
|  | Part No.   | 100907          | Ref. No. | — |
|   | screw connection thread M10x1 Qty 1 pcs type SEF 1 ømm for thermocouple              |                 |          |   |
|  | Part No.   | 100908          | Ref. No. | — |
|   | union screw thread M10x1 for pipe ø 4mm Qty 1 pcs                                    |                 |          |   |
|  | Part No.   | 100909          | Ref. No. | — |
|   | union screw thread M10x1 for pipe ø 6mm Qty 1 pcs                                    |                 |          |   |
|  | Part No.   | 102110          | Ref. No. | — |
|   | pilot tube copper pipe ø 4mm thickness 1mm L 3000mm                                  |                 |          |   |
|  | Part No.   | 102111          | Ref. No. | — |
|   | pilot tube copper pipe ø 6mm thickness 1mm L 3000mm                                  |                 |          |   |
|  | Part No.   | 102508          | Ref. No. | — |
|   | union screw thread M10x1 for pipe ø 4mm Qty 5 pcs                                    |                 |          |   |
|  | Part No.   | 102509          | Ref. No. | — |
|   | union screw thread M10x1 for pipe ø 6mm Qty 5 pcs                                    |                 |          |   |
|  | Part No.   | 102699          | Ref. No. | — |
|   | pilot burner nozzle POLIDORO natural gas code 25.2 bore ø 2x0.25mm Qty 1 pcs 2 bores |                 |          |   |

|   |  |        |          |   |
|---|--|--------|----------|---|
| <b>accessories for</b>  | 100076   |        |          |   |
|  | Part No.   | 102795 | Ref. No. | — |
|   | olive for pipe ø 4mm Qty 1 pcs   |        |          |   |
|  | Part No.   | 102797 | Ref. No. | — |
|   | olive for pipe ø 6mm Qty 1 pcs   |        |          |   |
|  | Part No.   | 106703 | Ref. No. | — |
|   | pilot burner nozzle POLIDORO natural gas code 27.2 bore ø 2x0.27mm Qty 1 pcs   |        |          |   |
|  | Part No.   | 106704 | Ref. No. | — |
|   | pilot burner nozzle POLIDORO LPG code 16.2 bore ø 2x0.16mm Qty 1 pcs           |        |          |   |
|  | Part No.   | 106763 | Ref. No. | — |
|   | pilot burner nozzle POLIDORO natural gas code 27.2A bore ø 2x 0.27mm Qty 1 pcs |        |          |   |
|  | Part No.   | 106859 | Ref. No. | — |
|   | pilot burner nozzle POLIDORO LPG code 24 bore ø 0.24mm Qty 1 pcs               |        |          |   |

## piezoelectric igniters

### miscellaneous



|   |  |                 |          |   |
|---|--|-----------------|----------|---|
| <b>Part No.</b>   | 107517   | <b>Ref. No.</b> | 03288    |   |
| <b>description</b>  | piezoelectric igniter suitable for Minisit connection F6.3x0.8 with cover cap ø 22mm |                 |          |   |
| <b>spare parts for</b>  | 107517   |                 |          |   |
|  | Part No.   | 107564          | Ref. No. | — |
|   | piezoelectric igniter body plastic blowing connection F6.3x0.8 ø 22mm                |                 |          |   |
| <b>accessories for</b>  | 107517   |                 |          |   |
|  | Part No.   | 100025          | Ref. No. | — |
|   | ignition cable cable length 600mm connection ø4mm / F6.3mm                           |                 |          |   |



## hinges

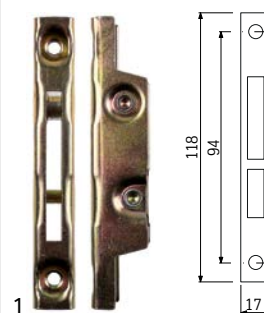

### oven hinges



|                    |  |                 |        |
|--------------------|--|-----------------|--------|
| <b>Part No.</b>    | 700001   | <b>Ref. No.</b> | 03808c |
| <b>description</b> | opposite support L 118mm W 17mm mounting distance 94mm |                 |        |

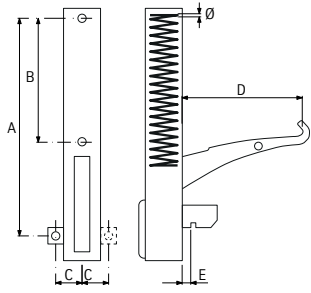

|   |  |                 |                        |
|---|--|-----------------|------------------------|
|  |  |                 |                        |
| 1   |  |                 |                        |
| <b>Part No.</b>   | 700006   | <b>Ref. No.</b> | 03478D                 |
| <b>description</b>  | oven hinge mounting distance 173mm mounting distance 2 105mm lug mounting 14mm lever length 120mm groove distance 11mm spring thickness 3.5mm mounting ear position left spring length 112mm W 25mm  |                 |                        |
| <b>accessories for</b>  | 700006   |                 |                        |
|  | <b>Part No.</b>  | 700001          | <b>Ref. No.</b> 03808c |
|   | opposite support L 118mm W 17mm mounting distance 94mm   |                 |                        |
|  | <b>Part No.</b>  | 700007          | <b>Ref. No.</b> 03478s |
|   | oven hinge mounting distance 173mm mounting distance 2 105mm lug mounting 14mm lever length 120mm groove distance 11mm spring thickness 3.5mm mounting ear position right spring length 112mm W 25mm |                 |                        |

|   |  |                 |                        |
|---|--|-----------------|------------------------|
|  |  |                 |                        |
| 1   |    |                 |                        |
| <b>Part No.</b>   | 700007   | <b>Ref. No.</b> | 03478s                 |
| <b>description</b>  | oven hinge mounting distance 173mm mounting distance 2 105mm lug mounting 14mm lever length 120mm groove distance 11mm spring thickness 3.5mm mounting ear position right spring length 112mm W 25mm |                 |                        |
| <b>accessories for</b>  | 700007   |                 |                        |
|  | <b>Part No.</b>  | 700001          | <b>Ref. No.</b> 03808c |
|   | opposite support L 118mm W 17mm mounting distance 94mm   |                 |                        |
|  | <b>Part No.</b>  | 700006          | <b>Ref. No.</b> 03478D |
|   | oven hinge mounting distance 173mm mounting distance 2 105mm lug mounting 14mm lever length 120mm groove distance 11mm spring thickness 3.5mm mounting ear position left spring length 112mm W 25mm  |                 |                        |

**GASTRO**PARTS.COM

