



**GASTROPARTS**

# Friginox

- [EN]** Equipment
- [DE]** Geräte
- [ES]** Aparatos
- [FR]** Équipement
- [IT]** Attrezzature
- [PL]** Urządzenia
- [RU]** Оборудование

✉ [gastroparts@gastroparts.com](mailto:gastroparts@gastroparts.com)

☎ +48 56 657 00 66

📘 [fb.com/gastroparts.global](https://fb.com/gastroparts.global)

**GASTROPARTS.COM**





## switches and momentary switches

### rocker/momentary rocker switches

30x22mm



1

<b>Part No.</b>	347791	<b>Ref. No.</b>	FX95040128
<b>description</b>	rocker switch mounting measurements 30x22mm green 2NO 230V 20A illuminated 0-I connection male faston 6.3mm ambient temperature max. 125/55°C protection IP65 with rubber collar		

### microswitches

with push button

switches with snap-fit



1

<b>Part No.</b>	348008	<b>Ref. No.</b>	FX95033270
<b>description</b>	microswitch with push button 250V 2.5A 1NO/1NC connection male faston 2.8mm/6.3mm L 27mm L1 22mm ambient temperature max. 104°C actuating force: 180g		

## electronic controllers

### ELIWELL

universal controllers

built-in version



1

<b>Part No.</b>	379690	<b>Ref. No.</b>	FX95040265
<b>description</b>	electronic controller ELIWELL type ICPlus902 model ICP16D0750000 mounting measurements 71x29mm 230V voltage AC NTC/PTC relay outputs 1 CO-15A(8) NTC/PTC built-in depth 60mm defr. funct. -50 up to +150°C display 3½ digits		
<b>accessories for</b>	379690		
	<b>Part No.</b>	378194	<b>Ref. No.</b> —
	temperature probe NTC 10kOhm cable PVC probe -20 up to +80°C cable -10 up to 100°C probe ø7x24.5mm cable length 1.5m without screw connection 2-wire		
	<b>Part No.</b>	379052	<b>Ref. No.</b> —
	temperature probe PTC 1kOhm cable silicone probe -50 up to +150°C cable -50 up to +180°C probe ø6x40mm cable length 1.5m without screw connection 2-wire		
	<b>Part No.</b>	379053	<b>Ref. No.</b> —
	temperature probe PTC 1kOhm cable PVC probe -50 up to +150°C cable -10 up to 100°C probe ø6x30mm cable length 3m without screw connection 2-wire		
	<b>Part No.</b>	379057	<b>Ref. No.</b> —
	temperature probe NTC 10kOhm cable PVC probe -20 up to +80°C cable -10 up to 100°C probe ø6x25mm cable length 3m 2-wire		

<b>accessories for</b>	379690		
	<b>Part No.</b>	379064	<b>Ref. No.</b> —
	temperature probe PTC 1kOhm cable silicone probe -50 up to +150°C cable -50 up to +180°C probe ø6x40mm cable length 3m without screw connection 2-wire		
	<b>Part No.</b>	379142	<b>Ref. No.</b> —
	temperature probe PTC 1kOhm cable PVC probe -50 up to +150°C cable -10 up to 100°C probe ø6x30mm cable length 1.5m without screw connection 2-wire		
	<b>Part No.</b>	379160	<b>Ref. No.</b> —
	temperature probe NTC 10kOhm cable thermoplastic probe -40 up to +110°C cable -40 up to +110°C probe ø6x14mm cable length 1.5m without screw connection 2-wire		
	<b>Part No.</b>	379161	<b>Ref. No.</b> —
	temperature probe NTC 10kOhm cable thermoplastic probe -40 up to +110°C cable -40 up to +110°C probe ø6x14mm cable length 3m without screw connection 2-wire		
	<b>Part No.</b>	379343	<b>Ref. No.</b> —
	temperature probe NTC 10kOhm cable silicone probe -40 up to +110°C cable -50 up to +180°C probe ø6x40mm cable length 3m 2-wire		
	<b>Part No.</b>	379458	<b>Ref. No.</b> —
	temperature probe NTC 10kOhm cable silicone probe -40 up to +110°C cable -50 up to +180°C probe ø6x40mm cable length 1.5m without screw connection 2-wire		
	<b>Part No.</b>	379781	<b>Ref. No.</b> —
	temperature probe PTC 1kOhm cable thermoplastic probe -50 up to +150°C cable -40 up to +110°C probe ø6x14mm cable length 1.5m without screw connection 2-wire		
	<b>Part No.</b>	379782	<b>Ref. No.</b> —
	temperature probe PTC 1kOhm cable thermoplastic probe -50 up to +150°C cable -40 up to +110°C probe ø6x14mm cable length 3m 2-wire resistor 1kOhm		

### refrigeration controllers

built-in version













1

<b>Part No.</b>	378298	<b>Ref. No.</b>	FX95040273
<b>description</b>	electronic controller ELIWELL type IDPlus 961 model IDP17D0700000 mounting measurements 71x29mm 230V voltage AC NTC/PTC/ Pt1000 relay outputs 1 NO-12A(12) NTC/PTC/Pt1000 front measurements 74x32mm built-in depth 67mm protection IP65 -55 up to +150°C display 3½ digits		
<b>accessories for</b>	378298		
	<b>Part No.</b>	379052	<b>Ref. No.</b> —
	temperature probe PTC 1kOhm cable silicone probe -50 up to +150°C cable -50 up to +180°C probe ø6x40mm cable length 1.5m without screw connection 2-wire		
	<b>Part No.</b>	379053	<b>Ref. No.</b> —
	temperature probe PTC 1kOhm cable PVC probe -50 up to +150°C cable -10 up to 100°C probe ø6x30mm cable length 3m without screw connection 2-wire		
	<b>Part No.</b>	379064	<b>Ref. No.</b> —
	temperature probe PTC 1kOhm cable silicone probe -50 up to +150°C cable -50 up to +180°C probe ø6x40mm cable length 3m without screw connection 2-wire		

Table continues overleaf



accessories for		378298	
Part No.		Ref. No.	
	379142	—	temperature probe PTC 1kOhm cable PVC probe -50 up to +150°C cable -10 up to 100°C probe ø6x30mm cable length 1.5m without screw connection 2-wire
	379160	—	temperature probe NTC 10kOhm cable thermoplastic probe -40 up to +110°C cable -40 up to +110°C probe ø6x14mm cable length 1.5m without screw connection 2-wire
	379161	—	temperature probe NTC 10kOhm cable thermoplastic probe -40 up to +110°C cable -40 up to +110°C probe ø6x14mm cable length 3m without screw connection 2-wire
	379162	—	temperature probe NTC 10kOhm cable thermoplastic probe -40 up to +110°C cable -40 up to +110°C probe ø6x14mm cable length 6m 2-wire
	379169	—	temperature probe NTC 10kOhm cable thermoplastic probe -40 up to +110°C cable -40 up to +110°C probe ø6x14mm cable length 2m without screw connection 2-wire
	379199	—	temperature probe PTC 1kOhm cable PVC probe -50 up to +150°C cable -10 up to 100°C probe ø6x30mm cable length 5m without screw connection 2-wire
	379343	—	temperature probe NTC 10kOhm cable silicone probe -40 up to +110°C cable -50 up to +180°C probe ø6x40mm cable length 3m 2-wire
	379458	—	temperature probe NTC 10kOhm cable silicone probe -40 up to +110°C cable -50 up to +180°C probe ø6x40mm cable length 1.5m without screw connection 2-wire
	379630	—	temperature probe NTC 10kOhm cable thermoplastic probe -40 up to +110°C cable -40 up to +110°C probe ø6x14mm cable length 2.5m without screw connection 2-wire resistor 10kOhm
	379804	—	protector for electronic controller 71x29 L 93mm W 65mm plexiglas
	381407	—	temperature probe Pt1000 probe -50 up to +110°C cable silicone°C probe ø5x20mm cable length 3m protection IP68

## compressors

## EMBRACO / ASPERA

R404a/R507

HMBP monophasé

High/Medium evaporation temperature above -20/-15 °C



1

Part No.	605161	Ref. No.	FX95055832
description	compressor coolant R404a/R507 type NEK6210GK 220-240V 50Hz HMBP fully hermetic 8.5kg 3/8HP cylinder capacity 8.78cm³ CSIR H 200mmW 566W 674W 815W 988W 1195W 1435W 1707W		

## L'UNITE HERMETIQUE / TECUMSEH

R404A

HMBP monophasé

High/Medium evaporation temperature above -20/-15 °C



1

Part No.	605151	Ref. No.	FX95055945
description	compressor coolant R404A type AE4440Z-FZ 220-240V 50Hz HMBP 10.5kg 1/3HP cylinder capacity 6.69cm³ CSIR H 206mmWWW 433W 546W 676W 826W 1000W 1199W test method EN 12900 ambient temperature max. 45°C		



locks

edgemount latches

handle latches

CAFF/FERMOD

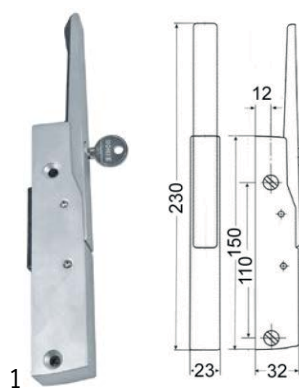

<b>Part No.</b>	690456	<b>Ref. No.</b>	FX95040124
<b>description</b>	handle latch L 150mm mounting distance 110mm matt chrome-plated lockable refrigeration units 571 R-L CT 26mm complete with door catch		
<b>spare parts for</b>	690456		
	<b>Part No.</b>	690429	<b>Ref. No.</b> —
	door catch CT 25.5mm		
<b>accessories for</b>	690456		
	<b>Part No.</b>	690428	<b>Ref. No.</b> —
	door catch H 51mm W 13.9mm mounting distance 30mm plastic CT 16.5mm		
	<b>Part No.</b>	690445	<b>Ref. No.</b> —
	base plate H 2mm		
	<b>Part No.</b>	690446	<b>Ref. No.</b> —
	base plate H 5mm L 56mm W 18mm		

hinges

edgemount hinges

CAFF/FERMOD

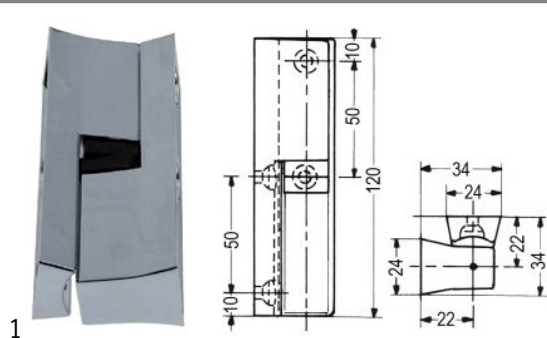

<b>Part No.</b>	700565	<b>Ref. No.</b>	FX95014445
<b>description</b>	edgemount hinge L 120mm W 24mm mounting distance 50/50mm hinging left/right without lift series G 308		
<b>accessories for</b>	700565		
	<b>Part No.</b>	690411	<b>Ref. No.</b> —
	base plate for type 308 thickness 8mm		

spring assisted hinges

universal

CAFF/FERMOD

group 2

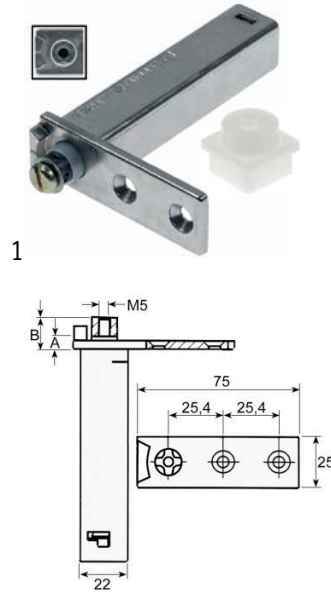

<b>Part No.</b>	690494	<b>Ref. No.</b>	95014601 fx95014601
<b>description</b>	spring assisted hinge series 175 mounting pos. left/right torx L 75mm W 25.6mm H 100mm A 4mm B 11mm mounting measurements 22x22mm intake torx refrigeration units mounting distance 25mm		

door bearing



<b>Part No.</b>	690583	<b>Ref. No.</b>	—
<b>description</b>	hinge bearing without bolt		

1 mechanical components, equipment accessories



# gaskets

## refrigeration gaskets

### plug-in gaskets

#### profile 9800

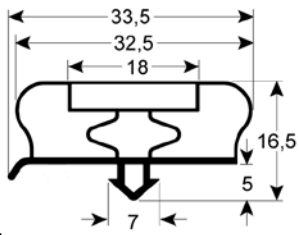

<b>Part No.</b>	901815	<b>Ref. No.</b>	FX95030516
<b>description</b>	refrigeration gasket profile 9800 W 200mm L 362mm		

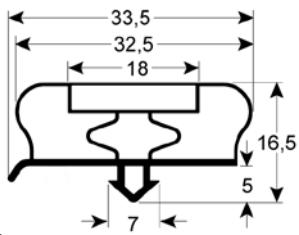

<b>Part No.</b>	901598	<b>Ref. No.</b>	FX95030151
<b>description</b>	refrigeration gasket profile 9800 W 355mm L 630mm plug size		

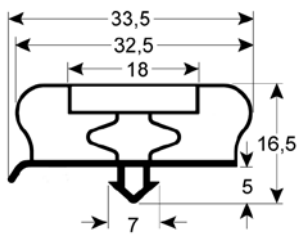

<b>Part No.</b>	901816	<b>Ref. No.</b>	FX95030136
<b>description</b>	refrigeration gasket profile 9800 W 425mm L 626mm plug size W 455 length 658 external size		

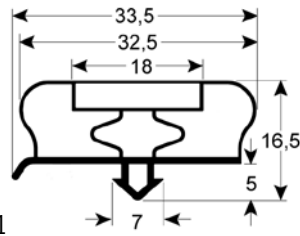

<b>Part No.</b>	901599	<b>Ref. No.</b>	FX95016523
<b>description</b>	refrigeration gasket profile 9800 W 560mm L 1525mm plug size		

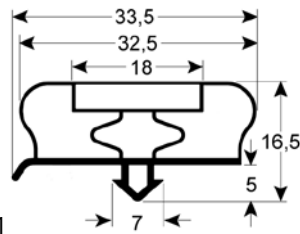

<b>Part No.</b>	901600	<b>Ref. No.</b>	FX95033163
<b>description</b>	refrigeration gasket profile 9800 W 640mm L 725mm plug size		

**GASTRO**PARTS.COM

