



GASTROPARTS

Fornitalia

- [EN]** Equipment
- [DE]** Geräte
- [ES]** Aparatos
- [FR]** Équipement
- [IT]** Attrezzature
- [PL]** Urządzenia
- [RU]** Оборудование

✉ gastroparts@gastroparts.com

☎ +48 56 657 00 66

📘 fb.com/gastroparts.global

GASTROPARTS.COM





heating elements

heating elements for pizza ovens



Part No.	418094	Ref. No.	105/65Z15 K105/65 15
description	heating element 1000W 230V L 600mm W 95mm thread 1/4" mounting distance 86mm connection length 84mm connection M4 tube ø 8.5mm heating circuits 1 dry heating element mounting pos. lower 2 hole fixing		

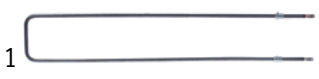

Part No.	418987	Ref. No.	K65/65 18
description	heating element 1000W 230V L 604mm W 113mm thread 1/4" mounting distance 105mm connection length 85mm connection M4 tube ø 8.5mm heating circuits 1 dry heating element mounting pos. upper 2 hole fixing pizza oven		







Part No.	419145	Ref. No.	K105/6518 K65/65 15
description	heating element 1000W 230V L 610mm W 94mm thread 1/4" mounting distance 86mm connection length 87mm connection M4 tube ø 8.5mm heating circuits 1 dry heating element mounting pos. upper 2 hole fixing		

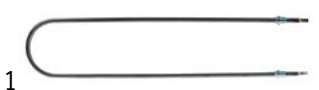

Part No.	419187	Ref. No.	K65/105 15
description	heating element 1600W 230V L 1000mm W 115mm thread 1/4" mounting distance 106.5mm connection length 85mm connection M4 tube ø 8.5mm heating circuits 1 dry heating element mounting pos. lower 2 hole fixing pizza oven		





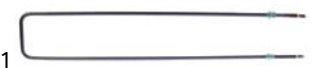

Part No.	418089	Ref. No.	40/60Z6
description	heating element 600W 230V L 480mm W 120mm thread 1/4" mounting distance 112mm connection length 42mm connection male faston 6.3mm tube ø 8.5mm heating circuits 1 dry heating element mounting pos. upper 2 hole fixing		
accessories for	418089		
	Part No.	361182	Ref. No. —
	nut thread 1/4" H 5mm nickel-plated brass WS 17 Qty 1 pcs		
	Part No.	510417	Ref. No. —
	flat gasket fibre ED ø 20mm ID ø 14mm thickness 2mm Qty 1 pcs		
	Part No.	520228	Ref. No. —
	tooth lock washer ID ø 15.3mm ED ø 24mm steel Qty 1 pcs for thread M14		
	Part No.	550262	Ref. No. —
	flat gasket copper ED ø 20mm ID ø 14mm thickness 2mm		



Part No.	418092	Ref. No.	65/65Z15 K65/65 15 K65/65 15 old version
description	heating element 600W 230V L 595mm W 122mm thread 1/4" mounting distance 115mm connection length 84mm connection M4 tube ø 8.5mm heating circuits 1 dry heating element mounting pos. lower 2 hole fixing		



Part No.	418090	Ref. No.	40/60Z7 BJ07
description	heating element 700W 230V L 480mm W 120mm thread 1/4" mounting distance 111mm connection length 55mm connection male faston 6.3mm tube ø 8.5mm heating circuits 1 dry heating element mounting pos. lower 2 hole fixing		
accessories for	418090		
	Part No.	361182	Ref. No. —
	nut thread 1/4" H 5mm nickel-plated brass WS 17 Qty 1 pcs		
	Part No.	510417	Ref. No. —
	flat gasket fibre ED ø 20mm ID ø 14mm thickness 2mm Qty 1 pcs		
	Part No.	520228	Ref. No. —
	tooth lock washer ID ø 15.3mm ED ø 24mm steel Qty 1 pcs for thread M14		
	Part No.	550262	Ref. No. —
	flat gasket copper ED ø 20mm ID ø 14mm thickness 2mm		

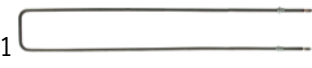

Part No.	418097	Ref. No.	105/105Z18
description	heating element 900W 230V L 1000mm W 195mm thread M14x1.5 mounting distance 186mm connection length 85mm connection M4 tube ø 8.5mm dry heating element mounting pos. upper 2 hole fixing		



thermostats

control and safety thermostats

EGO

control thermostats

55.10/19_series



Part No.	375253	Ref. No.	40/60Z17
description	thermostat t.max. 455°C temperature range 85-455°C 1-pole 1NO 16A probe ø 3.9mm probe L 228mm capillary pipe 870mm capillary pipe isolated 660mm gland nut shaft ø 6x4.6mm shaft L 23mm shaft position upper rotation 270°		

safety thermostats

55.10/19_series



Part No.	375191	Ref. No.	40/60Z19
description	safety thermostat switch-off temp. 500°C 1-pole 16A probe ø 3.9mm probe L 230mm capillary pipe 870mm capillary pipe isolated 660mm gland nut probe		

switches and momentary switches

cam switches

on/off

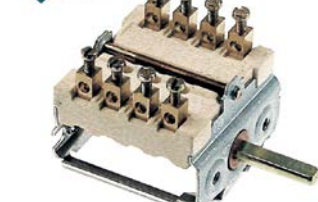

Part No.	300176	Ref. No.	40/60Z18
description	cam switch 2 operating positions 4NO sequence 0-1 16A shaft ø 6x4.6mm shaft L 23mm connection screw		

lamps

indicator lights

indicator lights (complete)

ø 6mm



1

Part No.	359336	Ref. No.	40/60Z12
description	indicator light ø 6mm 230V green		

screw-on/push-on fit

halogen lamp

for socket GU5.3 / GU10 / GZ5.3



1

Part No.	359496	Ref. No.	65/65Z10 K65/65
description	halogen lamp socket GU5.3 12V 50W temp.-resist. 300°C		

oven lamps

producer-specific oven lamps

FORNITALIA



1

Part No.	359495	Ref. No.	65/65Z11
description	frame without socket		



1

Part No.	359497	Ref. No.	65/65Z9 K65/6509
description	lamp glass ø 52mm		



1

Part No.	359498	Ref. No.	65/65Z7 K65/6507
description	spring for lens		



			
1			
Part No.	359496	Ref. No.	65/65Z10 K65/65
description	halogen lamp socket GU5.3 12V 50W temp.-resist. 300°C		

lamps
halogen lamps
for socket GU5,3 / GU10

			
1			
Part No.	359496	Ref. No.	65/65Z10 K65/65
description	halogen lamp socket GU5.3 12V 50W temp.-resist. 300°C		

transformers

open transformers

with clamp terminal

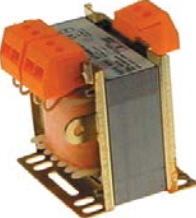
			
1			
Part No.	401176	Ref. No.	65/65Z26
description	transformer primary 230V secondary 10/24V 50VA		

for lighting

			
1			
Part No.	401177	Ref. No.	65/65Z24
description	transformer primary 230V secondary 11.5V 50W		

probes

producer-specific probes

			
1			
Part No.	379930	Ref. No.	65/65Z25
description	temperature probe thermocouple K (NiCr-Ni) cable Vetrotex probe -50 up to 1150°C cable -50 up to +350°C connection 2-wire thread probe ø3x100mm cable length 3.2m		

electronics

PCBs

			
1			
Part No.	401178	Ref. No.	105/105Z22 65/65 22 65/65Z22
description	control PCB		

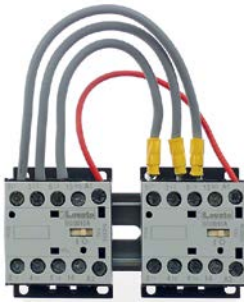
			
1			
Part No.	403643	Ref. No.	K65/65 23 (old version)
description	conversion kit pizza oven K65 suitable for FORNITALIA		

			
1			
Part No.	401179	Ref. No.	65/65Z23 K65/65 23 (old)
description	power PCB pizza oven K65 suitable for FORNITALIA		



1

Part No.	403072	Ref. No.	K65/65 23
description	power PCB pizza oven K65 suitable for FORNITALIA		

keypads

front foils

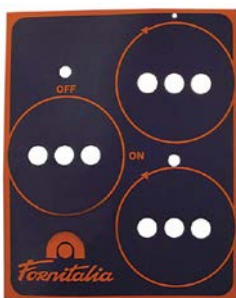

1

Part No.	693371	Ref. No.	40/60Z16
description	front foil		

fans

axial fans

import



1

Part No.	601158 ¹	Ref. No.	65/65Z20 B65/65 20
description	axial fan L 119mm W 119mm H 25mm 12VDC 5.4W bearing ball bearing connection cable 300mm plastic ADDA temp.-resist. -10 up to +70°C		

¹with ball bearings

accessories

fan guards

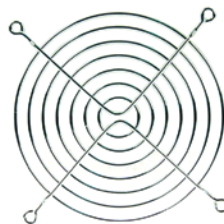

1

Part No.	601206	Ref. No.	65/65Z19
description	guard ø 115mm mounting distance 105mm for axial fan 119mm		

equipment-specific units

for pizza ovens

springs



1

Part No.	693369	Ref. No.	65/65Z1 B65/65 01
description	torsion spring ø 22mm L2 51mm wire gauge ø 3.7mm L1 38mm L3 15mm		

glass panels



1

Part No.	693374	Ref. No.	40/60Z1
description	glass panel L 258mm W 78mm thickness 4mm rectangular		



1

Part No.	693372	Ref. No.	16/K65/65 65/65Z16 K65/65 16
description	glass panel L 418mm W 103mm thickness 4mm rectangular		

firebricks



1

Part No.	850090	Ref. No.	K105/105 14
description	firebrick L 1025mm W 500mm H 15mm mounting pos. lower delivery freight forwarding company only		
For models:	KCK105/105		



1

Part No.	850092	Ref. No.	K65/105 14
description	firebrick L 1025mm W 605mm H 15mm mounting pos. lower delivery freight forwarding company only		



1

Part No.	850081	Ref. No.	KCK105/105 R5
description	firebrick L 1030mm W 160mm H 15mm with lamp duct mounting pos. side part right delivery freight forwarding company only		
For models:	KCK105/105		



1

Part No.	850082	Ref. No.	KCK105/105 R2
description	firebrick L 1030mm W 160mm H 15mm with probe duct mounting pos. side part left delivery freight forwarding company only		
For models:	KCK105/105		



1

Part No.	850083	Ref. No.	KCK105/105 R3
description	firebrick L 1045mm W 160mm H 15mm mounting pos. side part at the back delivery freight forwarding company only		
For models:	KCK105/105		



1

Part No.	850089	Ref. No.	KCK105/65 R4
description	firebrick L 1045mm W 325mm H 15mm mounting pos. upper delivery freight forwarding company only		
For models:	KCK105/65		



1



Part No.	850091	Ref. No.	KCK105/105 R4
description	firebrick L 1045mm W 520mm H 15mm mounting pos. upper delivery freight forwarding company only		
For models:	KCK105/105		

1



Part No.	850118	Ref. No.	K65/105 14
description	firebrick L 342mm W 605mm H 14mm mounting pos. lower delivery freight forwarding company only		
For models:	KCK65/105		

1



Part No.	850094	Ref. No.	K65/65 14
description	firebrick L 606mm W 313mm H 15mm mounting pos. lower Qty 2 pcs delivery freight forwarding company only		
For models:	KCK65/65		

1



Part No.	850095	Ref. No.	Bigou Z4 BJ04
description	firebrick L 625mm W 425mm H 15mm delivery freight forwarding company only		
For models:	BJ60/60		

1



Part No.	850087	Ref. No.	K105/65 14
description	firebrick L 625mm W 500mm H 15mm mounting pos. lower delivery freight forwarding company only		
For models:	KCK105/65		

1



Part No.	850085	Ref. No.	KCK65/65 R2
description	firebrick L 630mm W 160mm H 15mm with lamp duct mounting pos. side part left delivery freight forwarding company only		
For models:	KCK65/65		

1



Part No.	850084	Ref. No.	KCK65/65 R5
description	firebrick L 630mm W 160mm H 15mm with lamp duct mounting pos. side part right delivery freight forwarding company only		
For models:	KCK65/65		

1



Part No.	850086	Ref. No.	KCK65/65 R3
description	firebrick L 645mm W 160mm H 15mm mounting pos. side part at the back delivery freight forwarding company only		
For models:	KCK65/65		



1

Part No.	850088	Ref. No.	KCK65/105 R4
description	firebrick L 645mm W 520mm H 15mm mounting pos. upper delivery freight forwarding company only		
For models:	KCK65/105		



1

Part No.	850123	Ref. No.	KCK65/65 R4
description	firebrick L 645mm W 640mm H 15mm mounting pos. upper delivery freight forwarding company only		
For models:	KCK65/65		

doors



1

Part No.	693368	Ref. No.	65/65Z2 K65/65 02
description	bush for door		

knobs

universal knobs



1

Part No.	110253	Ref. No.	40/60Z13
description	knob switch zero mark t.max. °C ø 50mm shaft ø 6x4.6mm shaft flat upper black		

producer-specific knobs

FORNITALIA



1

Part No.	111742	Ref. No.	65/65Z13
description	knob potentiometer ø 78mm shaft ø 6x4.6mm shaft flat upper black		



1

Part No.	111740	Ref. No.	40/60Z15 BJ15
description	knob thermostat t.max. 450°C ø 49mm shaft ø 6x4.6mm shaft flat upper black temperature range 85-450°C rotation 270°		

handles and hand wheels

cone handles



1

Part No.	693370	Ref. No.	65/65Z17
description	cone handle thread M12x1.5 thread L 12.5mm		

filters

device filters

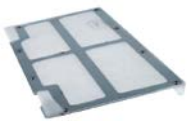

1

Part No.	693373	Ref. No.	65/65Z21 K65/65 21
description	filter		



springs

torsion springs



Part No.	693369	Ref. No.	65/65Z1 B65/65 01
description	torsion spring \varnothing 22mm L2 51mm wire gauge \varnothing 3.7mm L1 38mm L3 15mm		

GASTROPARTS.COM

