



GASTROPARTS

Chergui

- [EN]** Equipment
- [DE]** Geräte
- [ES]** Aparatos
- [FR]** Équipement
- [IT]** Attrezzature
- [PL]** Urządzenia
- [RU]** Оборудование

✉ gastroparts@gastroparts.com

☎ tel. +48 56 657 00 66

📘 fb.com/gastroparts.global

GASTROPARTS.COM





heating elements

heating elements for chicken rotisseries

1	
Part No.	418348
Ref. No.	03EFBL0030, RBL810R
description	heating element 1500W 230V round flange thread M6x1 L 810mm Wmm heating circuits 1 connection M6x1 L2 890mm flange ø 45mm dry heating element tube ø 16mm hole ø 5mm

1	
Part No.	418349
Ref. No.	03EFBL0050
description	heating element 1700W 230V round flange L 918mm heating circuits 1 connection M6x1 flange ø 45mm dry heating element tube ø 16mm hole ø 5mm

quartz heating elements

1	
Part No.	417652
Ref. No.	03EFBO0070
description	heating coil 435W 250Ohm L1 345mm ø 5.2mm

1	
Part No.	417651
Ref. No.	03EFBO0530
description	heating coil 435W 90Ohm L1 340mm ø 6.1mm

1	
Part No.	418475
Ref. No.	03EFBO0300
description	heating coil for quartz tube

1	
Part No.	418476
Ref. No.	03EFTQ0090
description	quartz tube L 190mm ID ø 7mm ED ø 11mm

1	
Part No.	417653
Ref. No.	03EFTQ0150
description	quartz tube L 400mm tube ø 11mm

1	
Part No.	418477
Ref. No.	03EFTQ0020
description	quartz tube WV L 350mm ID ø 7mm ED ø 11mm

thermostats

control and safety thermostats

EGO

control thermostats

55.13_ series



1

Part No.	375505	Ref. No.	03EDTH0020, EDTH002
description	thermostat t.max. 320°C temperature range 50-320°C 1-pole 1NO 16A probe ø 3mm probe L 160mm capillary pipe 870mm capillary pipe isolatedmm gland nut shaft ø 6x4.6mm shaft L 23mm shaft position upper rotation 270°		

switches and momentary switches

push/momentary push switches

30x22mm



1

Part No.	301084	Ref. No.	03EDIN0050, INTMB, EDIN005
description	push switch mounting measurements 30x22mm red 2NO 250V 12A connection male faston 6.3mm ambient temperature max. 85/55°C protection IP54 with protective collar		

toggle switches

M12x0.75



1

Part No.	346519	Ref. No.	03EDIN0030	
description	toggle switch thread M12x0.75 2NO 250V 15A ON-OFF male faston 6.3mm			
accessories for	346519			
	Part No.	346525	Ref. No.	—
	protection cap L 23.5mm W 17.3mm protection cap rubber thread M11			
	Part No.	347197	Ref. No.	—
	bezel ON-OFF for toggle switch M12			



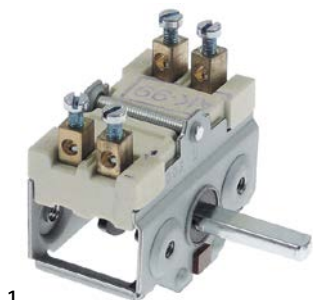

cam switches

on/off



1

Part No.	300020	Ref. No.	03EDCO0010 EDCO001
description	cam switch 4 operating positions 2NO sequence 0-1-0-1 16A shaft \varnothing 6x4.6mm shaft L 23mm connection screw ceramic		
accessories for	300020		
	Part No.	110135	Ref. No. —
	rosette knob up to \varnothing 52mm		
	Part No.	110231	Ref. No. —
	knob switch 0-1-0-1 t.max.°C \varnothing 50mm shaft \varnothing 6x4.6mm shaft flat upper black		

4-position



1

Part No.	300023	Ref. No.	03EDCO0020
description	cam switch 4 operating positions 1NO/2CO sequence 0-1-2-3 16A shaft \varnothing 6x4.6mm shaft L 23mm connection screw 4-position ceramic		

lamps

indicator lights

indicator lights 2-piece (lens and indicator lamp)

indicator light lenses

 \varnothing 12mm (type SDY-3)

1

Part No.	359261	Ref. No.	EDAM011
description	indicator light housings mounting measurements \varnothing 12mm red round Qty 1 pcs		

indicator lamps for socket type SRZ / SDK / SDY / SFK



1

Part No.	359430	Ref. No.	EDAM010
description	indicator lamp 230V clear connection cable 400mm		
accessories for	359430		
	Part No.	359260	Ref. No. —
	indicator light housings mounting measurements \varnothing 12mm yellow round Qty 1 pcs		

indicator lights (complete)

 \varnothing 12mm

with plug-in socket



1

Part No.	359691	Ref. No.	03EDAM0120
description	indicator light \varnothing 12mm 230V red with cable		

linear lamps

halogen lamps



1

Part No.	357090	Ref. No.	03EEAM0070
description	halogen lamp socket R7s L 117.6mm 230V 120W OSRAM HALOLINE ECO		

infrared lamps

with base type X lug



1

Part No.	359617	Ref. No.	03EEAMA0060, EEMA006
description	infrared lamp 1000W 220V L 365mm lens L 340mm total length 480mm with mounting strap		

with base type Z ceramic



1

Part No.	359699	Ref. No.	03EEAM0080
description	infrared lamp socket Z-ceramic L 122mm 220-240V 300W		



1



Part No.	359694	Ref. No.	03EEAM0080
description	infrared lamp socket Z-ceramic L 122mm 220-240V 300W cable length 300mm IMPORT		

sockets for linear lamps

R7s

1

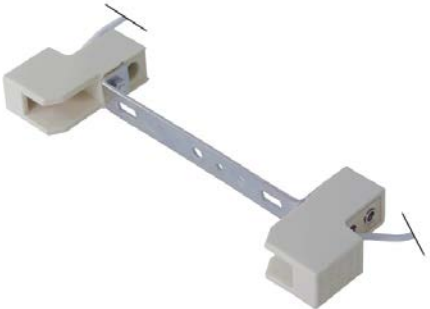

Part No.	359543	Ref. No.	03EEDO0040
description	lamp socket socket R7s 250V ømm for length of lamp 117.6mm H 43mm connection cable 150mm mounting distance 64mm holder length 140.5mm Qty 1 pcs		

1



Part No.	360688	Ref. No.	03EEO0010
description	reflector for length of lamp 117mm L 163mm W 78mm H 27mm mounting distance 156mm for halogen lamp Qty 1 pcs		

X lug

1



Part No.	359710	Ref. No.	03EEMA0060, EEMA006
description	lamp socket L 70mm W 70mm H 49mm mounting distance 50mm bracket mounting		

timers

mechanical timers

1



Part No.	350168	Ref. No.	03EDMI0030
description	timer C53 2-pole operation time 120min impulse mechanical 1NO/1NC at 250V 16A permanent position no shaft 6x4.6mm shaft L 23mm mounting distance 28mm connection lateral		

electronics

PCBs

1



Part No.	401560	Ref. No.	03EDCE0010
description	PCB		

motors

gear motors

for grills

1





Part No.	500795	Ref. No.	03KEMO0180
description	gear motor BITRON 2rpm shaft ø 15mm L 116mm W 72mm H 69mm		



			
1			
Part No.	500800	Ref. No.	03KEMO0060 03KEMP0060 03KEMP0060, MOTRP, MOTOR-RPE
description	gear motor BITRON type 39700022 28W 220V 50Hz 1.9rpm shaft ø 15mm L 106mm W 72mm H 70mm		

			
1			
Part No.	500799	Ref. No.	03KEMO0120 03KEMO0120, KEMO007
description	gear motor BITRON type 39700023 25W 230V 50Hz 1.9rpm shaft ø 9mm L 135mm W 70mm H 80mm		

			
1			
Part No.	500796	Ref. No.	03KEMO0080 old
description	gear motor 230V 50Hz 4.5rpm shaft ø 8mm L 96mm W 73mm H 73mm type B4415UI MERKLE		











			
1			
Part No.	499326	Ref. No.	03KEMO0080
description	gear motor 230V voltage AC 50Hz 4rpm turn direction clockwise shaft ø 8mm L 95mm W 60mm H 76mm hole distance 40mm type TT-YJ61/26L-624K W&W Motors		

			
1			
Part No.	500704	Ref. No.	03KEMO0120
description	gear motor SPG type K225 230V 50/60Hz 2/2.5rpm shaft ø 11x12mm L 150mm W 130mm H 90mm		











gas taps

PEL

20S series

				
1				
Part No.	101094	Ref. No.	04ZCCO0110	
description	gas tap PEL type 20S gas inlet M16x1.5 (tube ø 10mm) bypass nozzle ø 0.35mm gas outlet M16x1.5 (tube ø 10/8mm) thermocouple connection M8x1 pilot connection shaft ø 8x6.5mm shaft L 22/15mm shaft flat lower			
spare parts for	101094			
	Part No.	100408	Ref. No.	—
	bypass nozzle type PEL20/21 bore ø 0.35mm thread M5x0.5			
	Part No.	101060	Ref. No.	—
	magnet unit standard L 39mm D1 ø 15.4mm D2 ø 11mm suitable for PEL20-21/JUNKERS/EGA			
	Part No.	101205	Ref. No.	—
	gas tap front part shaft ø 8x6.5mm shaft L 22/15mm shaft flat upper/lower suitable for PEL20			
	Part No.	101230	Ref. No.	—
	thermocouple nut T1: M8x1 T2: M18x1 aluminium			
accessories for	101094			
	Part No.	101278	Ref. No.	—
	olive for pipe ø 10mm Qty 1 pcs			
	Part No.	101300	Ref. No.	—
	union nut thread M16x1.5 tube ø 10mm			
	Part No.	101450	Ref. No.	—
	olive for pipe ø 8mm L 12.7mm Qty 1 pcs ED ø 10mm			
	Part No.	101451	Ref. No.	—
	union nut thread M16x1.5 tube ø 8mm			
	Part No.	110081	Ref. No.	—
	knob ø 70mm shaft ø 8x6.5mm shaft flat universal			
	Part No.	110083	Ref. No.	—
	knob dial plate gas tap without ignition flame silver			



			
1			
Part No.	101491	Ref. No.	042CCO0110, ROBGAZ
description	gas tap PEL type 20S gas inlet M16x1.5 (tube ø 10mm) bypass nozzle ø 0.35mm gas outlet M16x1.5 (tube ø 10/8mm) thermocouple connection M9x1 pilot connection shaft ø 8x6.5mm shaft L 22/15mm shaft flat lower		
spare parts for	101491		
	Part No.	100408	Ref. No. —
	bypass nozzle type PEL20/21 bore ø 0.35mm thread M5x0.5		
	Part No.	101060	Ref. No. —
	magnet unit standard L 39mm D1 ø 15.4mm D2 ø 11mm suitable for PEL20-21/JUNKERS/EGA		
	Part No.	101205	Ref. No. —
	gas tap front part shaft ø 8x6.5mm shaft L 22/15mm shaft flat upper/lower suitable for PEL20		
	Part No.	101231	Ref. No. —
	thermocouple nut T1: M9x1 T2: M18x1		
accessories for	101491		
	Part No.	101287	Ref. No. —
	olive for pipe ø 6mm Qty 1 pcs		
	Part No.	101300	Ref. No. —
	union nut thread M16x1.5 tube ø 10mm		
	Part No.	101450	Ref. No. —
	olive for pipe ø 8mm L 12.7mm Qty 1 pcs ED ø 10mm		
	Part No.	101451	Ref. No. —
	union nut thread M16x1.5 tube ø 8mm		
	Part No.	110081	Ref. No. —
	knob ø 70mm shaft ø 8x6.5mm shaft flat universal		
	Part No.	110083	Ref. No. —
	knob dial plate gas tap without ignition flame silver		

ignition parts

thermocouples

thermocouple sets universal

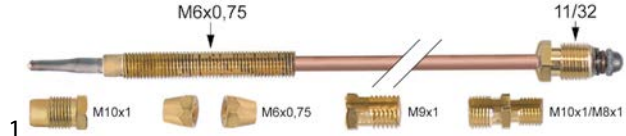
			
1			
Part No.	102006	Ref. No.	04ZCCO0050
description	thermocouple set 6-piece L 1200mm		



gas burners

ceramic burners

			
1			
Part No.	105934	Ref. No.	04ZCBR0050 04ZCBR0050, RAD785
description	ceramic burner L 785mm W 100mm firing range 745x38mm		

accessories



nozzle holders

			
1			
Part No.	102951	Ref. No.	04ZCIN0030
description	nozzle holder with nozzle ø1.35mm		
			
1			
Part No.	102950	Ref. No.	04ZCIN0020
description	nozzle holder with nozzle ø1.95mm		

gas nozzles

main nozzles

gas nozzles M8x1

			
1			
Part No.	102953	Ref. No.	04ZCIN0140
description	gas injector thread M8x1 WS 12 bore ø 1.1mm		
			
1			
Part No.	102952	Ref. No.	04ZCIN0130
description	gas injector thread M8x1 WS 12 bore ø 1.7mm		



equipment-specific units

for freezer cabinets

glass panels

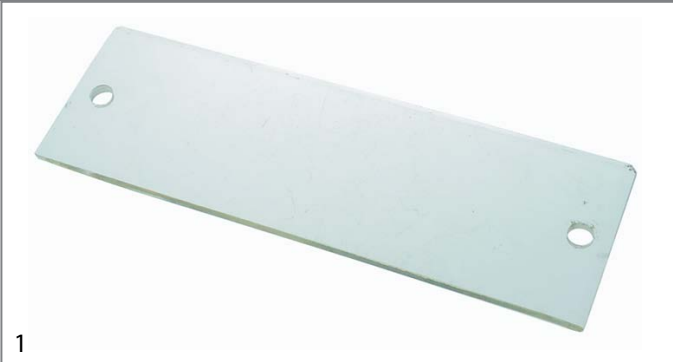

1	Part No.	693928	Ref. No.	02GCDI0010
	description	glass panel L 190mm W 60mm thickness 4mm rectangular		

for chicken rotisserie

skewers



1	Part No.	693492	Ref. No.	45DIV0000
	description	skewer chicken rotisserie L 780mm W 100mm shaft intake ø 11mm		

1	Part No.	693491	Ref. No.	01FABR0020
	description	skewer for chicken rotisserie L 780mm ø 10/11.5mm		
	accessories for	693491		
	Part No.	692693	Ref. No.	33FATO0060
	description	skewer clamp single mounting pos. skewermm skewer ø 3.2mm ø 12.5mm		

spit clamp



1	Part No.	692141	Ref. No.	33FATO0040
	description	skewer clamp for chicken rotisserie ID ø 17.5mm L 130mm W 73mm		



1	Part No.	693489	Ref. No.	33FATO0060 old version
	description	skewer clamp single		



1	Part No.	692693	Ref. No.	33FATO0060
	description	skewer clamp single mounting pos. skewermm skewer ø 3.2mm ø 12.5mm		

knobs

universal knobs



1	Part No.	112257	Ref. No.	04ZCCO0020
	description	knob gas tap with ignition flame PEL22/23 ø 70mm shaft ø 10x8mm shaft flat universal black		

producer-specific knobs

CHERGUI



1	Part No.	111937	Ref. No.	04ZCCO0010, MANROBGAZ
	description	knob		



1	Part No.	110262	Ref. No.	03EDMA0040, EDMA004
	description	knob switch zero mark ø 42mm shaft ø 6x4.6mm shaft flat upper blue		



			
1			
Part No.	112133	Ref. No.	04ZCCO0220
description	knob switch zero mark ø 53mm shaft ø 10x8mm shaft flat upper black		

GASTROPARTS.COM

