



GASTROPARTS

Celme

- [EN]** Equipment
- [DE]** Geräte
- [ES]** Aparatos
- [FR]** Équipement
- [IT]** Attrezzature
- [PL]** Urządzenia
- [RU]** Оборудование

✉ gastroparts@gastroparts.com

☎ tel. +48 56 657 00 66

📘 fb.com/gastroparts.global

GASTROPARTS.COM





switches and momentary switches

push/momentary push switches

overload switches



1

Part No.	347815	Ref. No.	60169
description	push switch KJD17 mounting measurements 45x22mm red/green 2NO 250V 10A 0-1 connection male faston 6.3mm ambient temperature max. 85°C protection IP54		

magnetic switches

M10x0.75

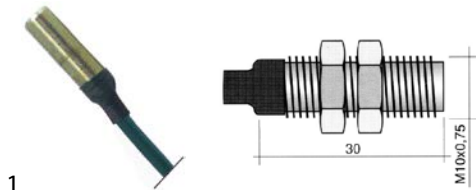

1

Part No.	345632	Ref. No.	605511	
description	magnetic switch thread M10x0.75 1NO 250V 0.5A P max. 50W connection cable cable length 2000mm type 102			
accessories for	345632			
	Part No.	100779	Ref. No.	—
	nut thread M10x0.75 H 3mm WS 14 SS Qty 2 pcs			

control equipment

GIOVENZANA

switches (complete)



1

Part No.	347396	Ref. No.	60523
description	mushroom momentary switch mounting measurements ø22mm red 1NC		

electronics

PCBs



1

Part No.	403599	Ref. No.	60906A
description	keypad PCB for vegetable slicer L 92.3mm W 82mm		



1

Part No.	403600	Ref. No.	60905A
description	keypad PCB for vegetable slicer L 92.3mm W 82mm		



1

Part No.	402489	Ref. No.	60948A	
description	PCB for vegetable slicer L 92mm W 82mm 230V/50Hz			
spare parts for	402489			
	Part No.	381109	Ref. No.	—
	print relay 24VAC 4NO at 250V 12A connection soldering connection raster size 10mm			

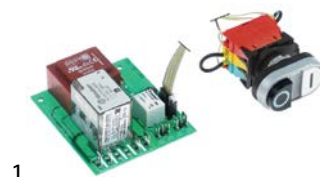

1

Part No.	402488	Ref. No.	60948
description	PCB for vegetable slicer L 92mm W 82mm cable length 350mm with momentary push switch		



			
1			
Part No.	402323	Ref. No.	60892 60892MN
description	PCB L 82mm W 65mm		

			
1			
Part No.	403151	Ref. No.	60906
description	PCB L 93mm W 82mm		

equipment-specific units

for slicers

adjustment knobs

			
1			
Part No.	698272	Ref. No.	74968
description	bush ϕ 20mm ID ϕ 14mm L 33mm brass		

eccentric disc for slice thickness

			
1			
Part No.	698338	Ref. No.	50322
description	eccentrics for cutting thickness hole ϕ 12mm groove width 6mm ED ϕ 56mm thickness 22.7mm plastic		

sharpener units

sharpener units

			
1			
Part No.	699182	Ref. No.	50126
description	blade sharpener		

grindstones

			
1			
Part No.	697567	Ref. No.	N/A
description	grindstone ϕ 40mm thickness 8.2mm bore ϕ 12mm grained fine with bevel, without hub		

for vegetable slicers

holders

			
1			
Part No.	697851	Ref. No.	80160
description	bracket for press lever H 83mm L 160mm vegetable slicers		

ejector discs

			
1			
Part No.	697292	Ref. No.	805556
description	ejector disc flat H 6mm ϕ 200mm seat ϕ 20.3mm shaft diameter 52mm hole distance 40mm		

			
1			
Part No.	697291	Ref. No.	505557
description	ejector disc high H 28mm ϕ 200mm seat ϕ 20.3mm hole distance 40mm		

grating discs

			
1			
Part No.	698404	Ref. No.	Z4
description	grating disc for vegetable slicer type Z4 ϕ 205mm seat ϕ 19mm slicing thickness 4mm		





			
1			
Part No.	697915	Ref. No.	V
description	grating disc ø 205mm seat ø 19mm plastic		

			
1			
Part No.	697838	Ref. No.	Z3 AK
description	grating disc ø 205mm seat ø 19mm slicing thickness 3mm SS/plastic		

cutting discs

blades smooth



blades

			
1			
Part No.	697418	Ref. No.	175701
description	spare blades for cutting disc E		
accessories for	697418		
	Part No.	697301	Ref. No. 970728 E2 AK
	slicing disk type E2 ø 206mm seat ø 19mm slicing thickness 2mm plastic		

cutting discs

			
1			
Part No.	697389	Ref. No.	E1 AK
description	slicing disk type E1 ø 206mm seat ø 19mm slicing thickness 1mm plastic		

			
1			
Part No.	698402	Ref. No.	E10 AL
description	slicing disk type E10 ø 205mm seat ø 19mm slicing thickness 10mm aluminium for vegetable slicer		

			
1			
Part No.	697301	Ref. No.	970728 E2 AK
description	slicing disk type E2 ø 206mm seat ø 19mm slicing thickness 2mm plastic		
spare parts for	697301		
	Part No.	697418	Ref. No. 175701
	spare blades for cutting disc E		

			
1			
Part No.	697297	Ref. No.	970729 E3 AK
description	slicing disk type E3 ø 206mm seat ø 19mm slicing thickness 3mm plastic		

blades round

			
1			
Part No.	697390	Ref. No.	970731 E5 AK
description	slicing disk type E5 ø 206mm seat ø 19mm slicing thickness 5mm plastic		

			
1			
Part No.	697391	Ref. No.	E1S AK
description	slicing disk type S1 ø 206mm seat ø 19mm slicing thickness 1mm plastic		

cubing grids

			
1			
Part No.	698403	Ref. No.	D10
description	cubing grid type D10 ø 210mm seat ø 32.5mm slicing thickness 10mm plastic		



for mozzarella slicers



1

Part No.	698337	Ref. No.	502114
description	handle kit for lid		

for cup coffee machines

plungers



1

Part No.	698337	Ref. No.	502114
description	handle kit for lid		

for tilting bratt pans

miscellaneous



1

Part No.	523510	Ref. No.	755620
description	deep-groove ball bearing type 6202-2RS shaft \varnothing 15mm ED \varnothing 35mm W 11mm with sealing discs deep-groove ball bearing DIN 625-1		

transmission technology and ball bearings

ball bearings

deep-groove ball bearings 2RS



1

Part No.	523510	Ref. No.	755620
description	deep-groove ball bearing type 6202-2RS shaft \varnothing 15mm ED \varnothing 35mm W 11mm with sealing discs deep-groove ball bearing DIN 625-1		

drive belts

poly-v belts

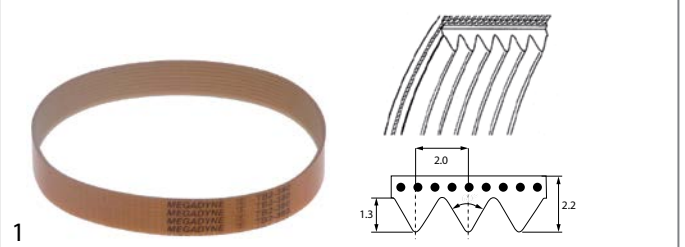

1

Part No.	697623	Ref. No.	815554
description	poly-v belt grooves 12 W 24mm L 675mm profile TB2		

GASTROPARTS.COM

