



GASTROPARTS

Bourgeat

- [EN]** Equipment
- [DE]** Geräte
- [ES]** Aparatos
- [FR]** Équipement
- [IT]** Attrezzature
- [PL]** Urządzenia
- [RU]** Оборудование

✉ gastroparts@gastroparts.com

☎ +48 56 657 00 66

📘 fb.com/gastroparts.global

GASTROPARTS.COM





heating elements

accessories

washers



1

Part No.	560112	Ref. No.	VI0072
description	plain washer ID ø 5.3mm ED ø 10mm thickness 1mm SS Qty 20 pcs DIN 125A for thread M5		

thermostats

bi-metal thermostats

safety bi-metal thermostats

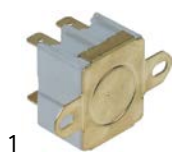

1

Part No.	390624	Ref. No.	BM0095
description	bi-metal safety thermostat hole distance 40mm switch-off temp. 125°C 2NC 2-pole 16A connection F6.3 2 hole fixing		

switches and momentary switches

rocker/momentary rocker switches

30x22mm



1

Part No.	347791	Ref. No.	480365 EH0011
description	rocker switch mounting measurements 30x22mm green 2NO 230V 20A illuminated 0-I connection male faston 6.3mm ambient temperature max. 125/55°C protection IP65 with rubber collar		

electronic controllers

ELIWELL

universal controllers

built-in version



1

Part No.	379690	Ref. No.	86029999
description	electronic controller ELIWELL type ICPplus902 model ICP16D0750000 mounting measurements 71x29mm 230V voltage AC NTC/PTC relay outputs 1 CO-15A(8) NTC/PTC built-in depth 60mm defr. funct. -50 up to +150°C display 3½ digits		
accessories for	379690		
	Part No.	Ref. No.	—
	378194		
	temperature probe NTC 10kOhm cable PVC probe -20 up to +80°C cable -10 up to 100°C probe ø7x24.5mm cable length 1.5m without screw connection 2-wire		
	Part No.	Ref. No.	EH0019
	379052		
	temperature probe PTC 1kOhm cable silicone probe -50 up to +150°C cable -50 up to +180°C probe ø6x40mm cable length 1.5m without screw connection 2-wire		
	Part No.	Ref. No.	—
	379053		
	temperature probe PTC 1kOhm cable PVC probe -50 up to +150°C cable -10 up to 100°C probe ø6x30mm cable length 3m without screw connection 2-wire		
	Part No.	Ref. No.	—
	379057		
	temperature probe NTC 10kOhm cable PVC probe -20 up to +80°C cable -10 up to 100°C probe ø6x25mm cable length 3m 2-wire		
	Part No.	Ref. No.	—
	379064		
	temperature probe PTC 1kOhm cable silicone probe -50 up to +150°C cable -50 up to +180°C probe ø6x40mm cable length 3m without screw connection 2-wire		
	Part No.	Ref. No.	—
	379142		
	temperature probe PTC 1kOhm cable PVC probe -50 up to +150°C cable -10 up to 100°C probe ø6x30mm cable length 1.5m without screw connection 2-wire		
	Part No.	Ref. No.	—
	379160		
	temperature probe NTC 10kOhm cable thermoplastic probe -40 up to +110°C cable -40 up to +110°C probe ø6x14mm cable length 1.5m without screw connection 2-wire		
	Part No.	Ref. No.	—
	379161		
	temperature probe NTC 10kOhm cable thermoplastic probe -40 up to +110°C cable -40 up to +110°C probe ø6x14mm cable length 3m without screw connection 2-wire		
	Part No.	Ref. No.	—
	379343		
	temperature probe NTC 10kOhm cable silicone probe -40 up to +110°C cable -50 up to +180°C probe ø6x40mm cable length 3m 2-wire		
	Part No.	Ref. No.	—
	379458		
	temperature probe NTC 10kOhm cable silicone probe -40 up to +110°C cable -50 up to +180°C probe ø6x40mm cable length 1.5m without screw connection 2-wire		
	Part No.	Ref. No.	—
	379781		
	temperature probe PTC 1kOhm cable thermoplastic probe -50 up to +150°C cable -40 up to +110°C probe ø6x14mm cable length 1.5m without screw connection 2-wire		

Table continues overleaf



accessories for	379690		
Part No.	379782	Ref. No.	—
temperature probe PTC 1kOhm cable thermoplastic probe -50 up to +150°C cable -40 up to +110°C probe ø6x14mm cable length 3m 2-wire resistor 1kOhm			

probes

universal probes

temperature probes

1 			
Part No.	379052	Ref. No.	EH0019
description temperature probe PTC 1kOhm cable silicone probe -50 up to +150°C cable -50 up to +180°C probe ø6x40mm cable length 1.5m without screw connection 2-wire			

fans

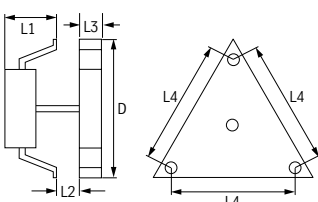

hot air fans

ebm-papst

1 			
			
Part No.	601249	Ref. No.	480370 EH0018
description hot air fan 230V 32W 0.27A L1 60mm L2 20mm L3 20mm L4 157mm fan wheel ø 150mm ebm-papst type R2K150-AC01-15			

pumps

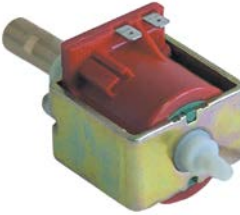



vibration pumps

1 			
Part No.	500124	Ref. No.	EH0137
description vibration pump type EX 5 230V 48W 50/60Hz inlet ø 6 outlet ø 1/8" IT flat seal ULKA brass L 123mm			
accessories for 500124			
	Part No.	520152	Ref. No. —
description hose connector Santoprene grommet ø 7mm grommet length 14mm			
	Part No.	520330	Ref. No. —
description bracket rubber dimensions 69x44x4mm			

STEINCO

with bolt hole

stainless steel

1 			
Part No.	700323	Ref. No.	RO0012
description swivel castor ø 125mm bolt hole bolt hole ø 10.5mm housing SS capacity 100kg bearing ball bearing wheel body polyamide tread TPE tyres H 158mm wheel width 32mm Qty 1 pcs			
accessories for 700323			
	Part No.	560190	Ref. No. —
description cylinder head bolt thread M10 L 80mm thread L 35mm WS 8 intake hexagonal zinc-coated steel Qty 1 pcs DIN 912/ISO 4762			
	Part No.	560193	Ref. No. —
description tooth lock washer ID ø 10.4mm ED ø 18mm zinc-coated steel DIN/ISO DIN 6798A Qty 1 pcs for thread M10			
	Part No.	700148	Ref. No. —
description sleeve suitable for circular pipes ED ø 27.5 - 30mm ID ø M10mm			
	Part No.	700150	Ref. No. —
description sleeve suitable for square pipes external size 25x25 - 28x28mm			



gaskets

gaskets for heated units

door seals

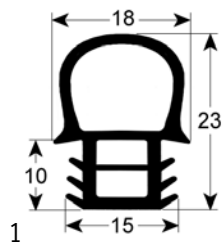

Part No.	901602	Ref. No.	EH0122
description	door seal profile 2055 W 580mm L 1495mm external size suitable for BOURGEAT		

special gaskets

miscellaneous

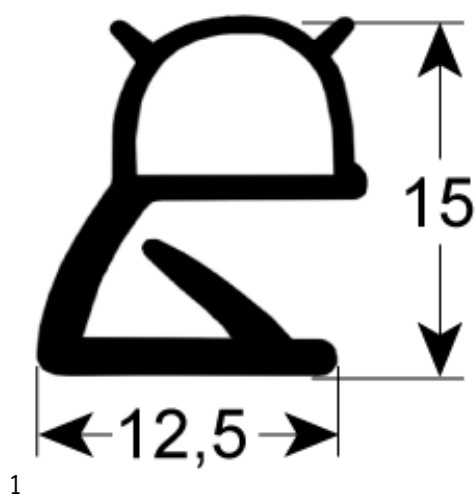

Part No.	901579	Ref. No.	76954016
description	door seal suitable for BOURGEAT for technical chamber door L 1335mm with metal reinforcement		

kitchen accessories

baking sheets



Part No.	694551	Ref. No.	310157
description	baking sheet W 324mm L 530mm H 11mm blued steel perforated		



Part No.	694550	Ref. No.	310107
description	baking sheet W 325mm L 530mm H 11mm blued steel size GN 1/1		

tools

safety clothing



Part No.	802063	Ref. No.	773011
description	gloves leather temp.-resist. up to 300°C L 330mm		



Part No.	802064	Ref. No.	773025
description	hand protection silicone temp.-resist. up to 300°C L 210mm		

fastening material

screws

sheet metal screws

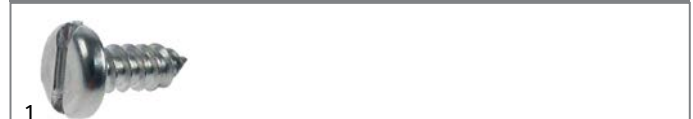

Part No.	560566	Ref. No.	VI0130
description	sheet-metal screw ø 4.5mm L 15.5mm SS Qty 1 pcs head ø 9.5mm		

washers

washers

DIN 125A



Part No.	560112	Ref. No.	VI0072
description	plain washer ID ø 5.3mm ED ø 10mm thickness 1mm SS Qty 20 pcs DIN 125A for thread M5		

mechanical components,
equipment accessories
1



miscellaneous



1

Part No.	560496	Ref. No.	480903 VI0072
description	plain washer ID \varnothing 5.5mm ED \varnothing 12mm thickness 0.8mm SS Qty 1 pcs for thread M5		

GASTROPARTS.COM

