



GASTROPARTS

Bianchi Vending

[EN] Equipment

[DE] Geräte

[ES] Aparatos

[FR] Équipement

[IT] Attrezzature

[PL] Urządzenia

[RU] Оборудование

✉ gastroparts@gastroparts.com

☎ +48 56 657 00 66

📘 fb.com/gastroparts.global



GASTROPARTS.COM





heating elements

heating elements for coffee machine

 <p>1</p>			
Part No.	417048	Ref. No.	29006911
description	heating element 2400W 230V heating circuits 2 thread 1¼" L 235mm W 34mm H 24mm tube ø 8.4mm connection male faston 6.3mm immersion heater connection length 31mm flange with thread WS 37		
accessories for	417048		
	Part No.	Ref. No.	—
	510405		
description	flat gasket fibre ED ø 56mm ID ø 42mm thickness 2mm for thread 1¼" Qty 1 pcs		
	Part No.	Ref. No.	—
	528021		
description	flat gasket PTFE ED ø 53mm ID ø 42.5mm thickness 3mm Qty 1 pcs equiv. no. 12001/02286 suitable for Astoria/Aurora/Brasilia/Wega		

 <p>1</p>			
Part No.	420490	Ref. No.	29007011
description	heating element 3000W 230V heating circuits 2 mounting ø 49mm hole distance 57.5mm L 340mm W 27mm H 50mm L1 35mm L2 55mm L3 235mm hole ø 10.5mm tube ø 8mm		

switches and momentary switches

push/momentary push switches

20.6x16.4mm

 <p>1</p>			
Part No.	348141	Ref. No.	0003170601 43052810
description	push switch mounting measurements 20.6x16.4mm black/chrome 2NO 250V 16A connection male faston 6.3mm ambient temperature max. 85°C protection IP40		

ø25mm

 <p>1</p>			
Part No.	348142	Ref. No.	26053416
description	momentary switch mounting ø 25mm red 1NO/indicator light 250V 16A connection male faston 6.3mm ambient temperature max. 85°C protection IP40		

microswitches

lever actuated

 <p>1</p>			
Part No.	348180	Ref. No.	41022916 8841022916
description	microswitch 250V 16A 1CO connection F6.3 L 27mm mounting distance 22mm		

 <p>1</p>			
Part No.	381416	Ref. No.	8826004346
description	microswitch 250V 5A 1CO connection F6.3 L 40mm mounting distance 22mm actuating force: 250g		

float switches

 <p>1</p>			
Part No.	348160	Ref. No.	93012020-01 93012020-02
description	float switch 2CO ø 6/13mm L 115mmV 6mm		



relays



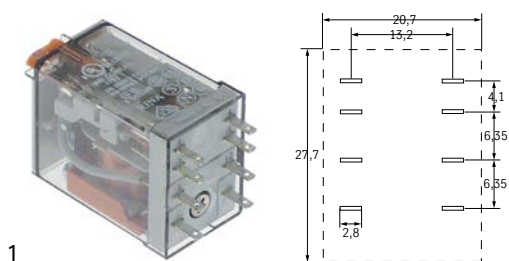

power relays

with male contacts

female contact 2.0mm



1

Part No.	381415	Ref. No.	26017316 8826017316
description	power relays 24VAC 10A 2CO connection F2 plug-in connection manuf. no. 55.32.8.024.0040 94.92.3 250V connection 2mm		
accessories for	381415		
	Part No.	380341	Ref. No. —
	relay socket 4-pole contacts 12 300V voltage AC 6A Italiana Relè manuf. no. ZMD4		
	Part No.	380378	Ref. No. —
	relay socket 2-pole 55/85 dimensions 70.5x30x27mm 250V voltage AC 10A FINDER manuf. no. 94.72		
	Part No.	380384	Ref. No. —
	relay socket 2-pole contacts male faston 2.8mm 250V voltage AC 10A W 23mm for		
	Part No.	380399	Ref. No. —
	relay socket 4-pole dimensions 76.2x27x86.1mm 250V voltage AC 1A FINDER manuf. no. 94.94.3		

level relays

GICAR



1

Part No.	402103	Ref. No.	26053616
description	level controller 230/240V voltage AC 50/60Hz connection F6.3 type NRL30/1E-2C/F		

electronics

central units



1

Part No.	402939	Ref. No.	26053716
description	central unit 2-group 230V 50/60Hz type 3d5 Maestro 2GRCD voltage AC		



1

Part No.	403083	Ref. No.	26053916
description	control box 230V 50/60Hz type 3d5 3GRC XLC (SC)		

keypads

membrane keypads



1

Part No.	403152	Ref. No.	000475.06.08 30265811 30265811-01
description	membrane keypad espresso machine buttons 5 L 125mm W 45mm		



solenoid valves

solenoid valves (water)

metal

OLAB

solenoid valves

3-way



1

Part No.	370822	Ref. No.	25018016 8825018016
description	solenoid valve brass 3-ways 24VAC inlet 1/8" ET outlet 1/8" IT connection 1/8" L 50mm DNmm slide-on receptacle DIN Olab coil type 8000 membranes NBR p maxbar p minbar		





PARKER

3-way

VE-128 series



1

Part No.	370057	Ref. No.	000322.06.01
description	solenoid valve 3-ways 230VAC body outer cone DN 1.2mm slide-on receptacle DIN -20° up to 140°C PARKER type series VE-128 coil type ZB09 membranes ruby p max 10bar brass flange 32x32mm		
spare parts for	370057		
	Part No.	370062	Ref. No. —
	solenoid valve body PARKER 3-ways outer cone		
	Part No.	371029	Ref. No. —
	solenoid coil PARKER 230VAC 9VA coil type ZB09 seat ø 14mm H 33mm W 34mm D 43mm		
accessories for	370057		
	Part No.	371090	Ref. No. —
	power socket plug type DIN 43650A screw		
	Part No.	371095	Ref. No. —
	O-ring Viton thickness 1.78mm ID ø 6.07mm Qty 1 pcs		
	Part No.	371100	Ref. No. —
	O-ring silicone thickness 1.78mm ID ø 6.07mm Qty 1 pcs		



1

Part No.	370693	Ref. No.	25034416
description	solenoid valve 3-ways 230VAC body outer cone slide-on receptacle DIN -20° up to 140°C PARKER type series VE 128R coil type ZB09 membranes ruby p max 20bar 230V brass voltage AC flange 32x32mm		

pressure switches

for coffee machines

miscellaneous



1

Part No.	541453	Ref. No.	25034516
description	pressure control pressure range adjustable 0.5-1.4bar connection 1/4" 25A 3-pole type PS325 pressure connection vertical 250V coffee machine parts PARKER		

electrodes



1

Part No.	400214	Ref. No.	26053126
description	level electrode 1/4" total length 140mm probe L 112mm insulated probe length 26mm connection male faston 6.3mm stainless steel ø 2.5mm		

flow meters and flow sensors

flow meters

DIGMESA



1

Part No.	403663	Ref. No.	24021916
description	flow meter thread 1/4" brass approval NSF reducer ø 1.2mm		



VENDING



1

Part No.	400565	Ref. No.	24011216 8824011216
description	flow meter hose ø 6mm plastic plug-in connection approval NSF DIGMESA		

fans

cross flow fans

COPREL

with standard coil



1

Part No.	602060	Ref. No.	20015916
description	cross flow fan COPREL FFR roller ø 60mm roller length 240mm laminated core thickness 20mm motor position right 230V/50-60Hz 33W universal bearing silicone connection male faston 6.3mm airflow 149m³/h -10 up to +60°C		



1

Part No.	602117	Ref. No.	20021016
description	cross flow fan COPREL FFR roller ø 60mm roller length 270mm laminated core thickness 20mm motor position right 230V/50-60Hz 30W universal bearing silicone connection male faston 6.3mm airflow 149m³/h -10 up to +60°C		

pumps

booster pumps II

pump heads

FLUID-O-TECH



1

Part No.	500454	Ref. No.	27011516
description	pump head PA1504 FLUID-O-TECH L 82mm 150l/h connection 3/8" NPT with bypass brass clip connection for coffee machine shaft ø 4.8x11mm approval NSF		

vibration pumps



1

Part No.	501533	Ref. No.	27002816 8827002816
description	vibration pump type 1106DHDLM1E 230V 50Hz 70W inlet ø 8mm outlet ø 1/8" IT outlet conical L 129mm FLUID-O-TECH		

equipment-specific units

for espresso machines

filter holders

filter holders standard

filter holders (complete)





1

Part No.	531289	Ref. No.	12047711
description	filter holder single complete mounting ø 83mm ID ø 62mm wedge hight 6mm number of wedges 2		





spouts			
with thread 3/8"			
			
Part No.	531163	Ref. No.	43051816
description	filter holder spout thread 3/8" 1-way curved/long outlet distance cups 1 thread L 11mm		

			
Part No.	531164	Ref. No.	43052116
description	filter holder spout thread 3/8" 2-way curved/long outlet distance 44mm cups 2 thread L 11mm		

filters			
for 1 cup			
			
Part No.	531290	Ref. No.	16022811
description	coffee filter ø 70mm mounting ø 60.8mm H 24.5mm cups 1		

for 2 cups			
			
Part No.	531291	Ref. No.	16022911
description	coffee filter ø 70mm mounting ø 60.8mm H 24.5mm cups 2		

filter holder springs			
			
Part No.	531243	Ref. No.	N/A
description	filter holder spring L 70mm W 60mm wire gauge ø 1.3mm for espresso filter holder Qty 20 pcs		

brewing units			
shower screens			
with upstand			
			
Part No.	525844	Ref. No.	16022711
description	shower screen ø 55.3mm H 18.2mm		

filter holder gaskets			
flat			
standard			
			
Part No.	528031	Ref. No.	000610.07.01 36361516
description	filter holder gasket D1 ø 73mm D2 ø 57mm H 8.5mm rubber Qty 1 pcs		

brewing units with solenoid valve			
components			
			
Part No.	526566	Ref. No.	04063116
description	drain pipe 1/8" L 35mm WS 22		

water dispersions			
water dispersions			
group 2			
			
Part No.	525756	Ref. No.	43051216
description	water distributor ø 30mm hole ø 1.5mm H 15mm ET M10x1 grooves 6 2.6mm brass 2 holes perforation ø 1mm		



safety valves

safety valves

3/8"



1

Part No.	531182	Ref. No.	04056716
-----------------	--------	-----------------	----------

description	safety valve connection 3/8" triggering pressurebar thread 3/8"		
--------------------	---	--	--

drain pans

drain pans



1

Part No.	530627	Ref. No.	05262015-01M09
-----------------	--------	-----------------	----------------

description	drain pan L 130mm W 80mm H 60mm		
--------------------	---------------------------------	--	--

level glasses

level glasses

level glasses (complete)



1

Part No.	531181	Ref. No.	05265410
-----------------	--------	-----------------	----------

description	water level tube L 165mm W 65mm ø 11mm 3/8"		
--------------------	---	--	--

gaskets

O-rings

EPDM

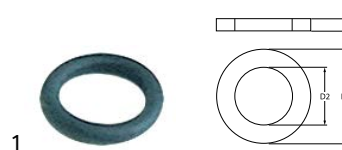

1

Part No.	529412	Ref. No.	36361216
-----------------	--------	-----------------	----------

description	O-ring EPDM thickness 2.62mm ID ø 10.78mm Qty 1 pcs		
--------------------	---	--	--

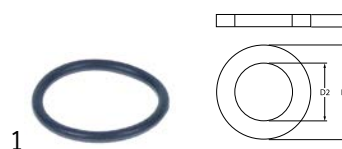

1

Part No.	532499	Ref. No.	36212616-01
-----------------	--------	-----------------	-------------

description	O-ring EPDM thickness 2.62mm ID ø 23.47mm Qty 1 pcs		
--------------------	---	--	--

GASTROPARTS.COM

