



**GASTROPARTS**

# Arris

- [EN]** Equipment
- [DE]** Geräte
- [ES]** Aparatos
- [FR]** Équipement
- [IT]** Attrezzature
- [PL]** Urządzenia
- [RU]** Оборудование

✉ [gastroparts@gastroparts.com](mailto:gastroparts@gastroparts.com)

☎ +48 56 657 00 66

📘 [fb.com/gastroparts.global](https://fb.com/gastroparts.global)

**GASTROPARTS.COM**





## heating elements

### heating elements for griddles

1 			
<b>Part No.</b>	418627	<b>Ref. No.</b>	90.046 90.046/2 + 90.131/1
<b>description</b>	heating element 440W 115V heating circuits 1 L 560mm W 25mm tube ø 6.3mm connection M4 mounting distance 19mm		

1 			
<b>Part No.</b>	419030	<b>Ref. No.</b>	90.046/2
<b>description</b>	heating element 440W 115V heating circuits 1 L 580mm W 23mm Hmm tube ø 6.3mm cable length 160mm		

## energy regulators

### EGO

#### 1-circuit

1 			
<b>Part No.</b>	380015	<b>Ref. No.</b>	PR001
<b>description</b>	energy regulator 230V 13A single-circuit turn direction right shaft ø 6x4.6mm shaft L 23mm mounting thread M4 power release 6-100% no. 50.57021.010		

## lamps

### indicator lights

#### indicator lights (complete)

ø10mm

with screw socket

1 			
<b>Part No.</b>	359469	<b>Ref. No.</b>	1.123 / 2
<b>description</b>	indicator light ø 10mm 240V yellow cable length 200mm temp.-resist. 120°C with screw connection		

1 			
<b>Part No.</b>	359468	<b>Ref. No.</b>	1.123 / 1
<b>description</b>	indicator light ø 10mm 250V green cable length 200mm temp.-resist. 120°C with screw connection		

## electric accessories

### terminals



#### terminal blocks

1 			
<b>Part No.</b>	550838	<b>Ref. No.</b>	90.131/1
<b>description</b>	lustre terminal 12-pole cross section 6mm² max. 41A max 750V temp.-resist. 150°C		

## gas taps

### PEL

#### 21S series







1 				
<b>Part No.</b>	102557	<b>Ref. No.</b>	90.071	
<b>description</b>	gas tap PEL type 21S gas inlet M16x1.5 (tube ø 10mm) bypass nozzle ø 0.35mm gas outlet M16x1.5 (tube ø 10/8mm) thermocouple connection M8x1 pilot connection M10x1 shaft ø 8x6.5mm shaft L 22/15mm shaft flat upper			
<b>spare parts for</b>	102557			
	<b>Part No.</b>	100531	<b>Ref. No.</b>	—
	bypass nozzle type PEL20/21 bore ø 1.15mm thread M5x0.5			
	<b>Part No.</b>	101230	<b>Ref. No.</b>	—
	thermocouple nut T1: M8x1 T2: M18x1 aluminium			

#### 22S/O series

1 				
<b>Part No.</b>	102558	<b>Ref. No.</b>	90.020	
<b>description</b>	gas tap PEL type 22S/O gas inlet M20x1.5 (tube ø 12mm) bypass nozzle ø 1.8mm gas outlet M20x1.5 (tube ø 12/10mm) thermocouple connection M8x1 pilot connection M10x1 shaft ø 10x8mm shaft L 25/17mm shaft flat lower			
<b>spare parts for</b>	102558			
	<b>Part No.</b>	101058	<b>Ref. No.</b>	—
	magnet unit L 39mm D1 ø 15.4mm D2 ø 13.5mm suitable for PEL22/EGA24197 standard			
	<b>Part No.</b>	101201	<b>Ref. No.</b>	—
	gas tap front part shaft ø 10x8mm shaft L 25/17mm shaft flat upper/lower suitable for PEL22			

Table continues overleaf



spare parts for		102558	
	Part No.	101230	Ref. No. —
	thermocouple nut T1: M8x1 T2: M18x1 aluminium		
	Part No.	101240	Ref. No. —
	gas connection thread M20x1.5 tube ø 12/10mm for PEL gas taps with gasket and screws horizontal		
	Part No.	101460	Ref. No. —
	O-ring ø 12.37mm D1 ø 2.62mm suitable for PEL22		
	Part No.	101461	Ref. No. —
	screw kit suitable for PEL22 Qty 4 pcs		
	Part No.	106656	Ref. No. —
	bypass nozzle type PEL22 bore ø 1.8mm thread M6x0.5		
accessories for		102558	
	Part No.	100908	Ref. No. —
	union screw thread M10x1 for pipe ø 4mm Qty 1 pcs		
	Part No.	100909	Ref. No. —
	union screw thread M10x1 for pipe ø 6mm Qty 1 pcs		
	Part No.	101241	Ref. No. —
	gas connection thread M20x1.5 tube ø 12/10mm for PEL gas taps vertical		
	Part No.	101246	Ref. No. —
	olive for pipe ø 4mm Qty 1 pcs		
	Part No.	101248	Ref. No. —
	olive for pipe ø 12mm Qty 1 pcs suitable for PEL		
	Part No.	101249	Ref. No. —
	olive for pipe ø 10mm Qty 1 pcs		
	Part No.	101250	Ref. No. —
	union nut thread M20x1.5 for pipe ø 10mm		
	Part No.	101251	Ref. No. —
	union nut thread M20x1.5 for pipe ø 12mm		
	Part No.	101286	Ref. No. —
	olive ID ø 6mm Qty 1 pcs		
	Part No.	110080	Ref. No. —
	knob ø 70mm shaft ø 10x8mm shaft flat universal		
	Part No.	112206	Ref. No. —
	knob dial plate silver gas tap PEL21/22/23 t.max. °C ED ø 63mm ID ø 45.5mm		

## ignition parts

## pilot burners

## POLIDORO

## pilot burners

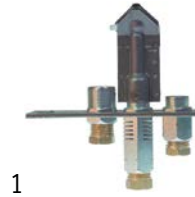

1

















Part No.	102982	Ref. No.	90.027
description	pilot burner POLIDORO 3 flames code gas connection 6mm		
accessories for	102982		
	Part No.	100000	Ref. No. —
	pilot burner nozzle POLIDORO LPG code 22 bore ø 0.22mm Qty 1 pcs		
	Part No.	100208	Ref. No. —
	pilot burner nozzle POLIDORO LPG code 20 bore ø 0.2mm Qty 1 pcs		
	Part No.	100209	Ref. No. —
	pilot burner nozzle POLIDORO natural gas code 40 bore ø 0.4mm Qty 1 pcs		
	Part No.	100701	Ref. No. —
	ignition electrode connection M4 Qty 1 pcs		
	Part No.	100906	Ref. No. —
	screw connection thread M10x1 for ignition electrode brass Qty 1 pcs WS 10		
	Part No.	100907	Ref. No. —
	screw connection thread M10x1 Qty 1 pcs type SEF 1 ømm for thermocouple		
	Part No.	100908	Ref. No. —
	union screw thread M10x1 for pipe ø 4mm Qty 1 pcs		
	Part No.	100909	Ref. No. —
	union screw thread M10x1 for pipe ø 6mm Qty 1 pcs		
	Part No.	102110	Ref. No. —
	pilot tube copper pipe ø 4mm thickness 1mm L 3000mm		
	Part No.	102111	Ref. No. —
	pilot tube copper pipe ø 6mm thickness 1mm L 3000mm		
	Part No.	102699	Ref. No. —
	pilot burner nozzle POLIDORO natural gas code 25.2 bore ø 2x0.25mm Qty 1 pcs 2 bores		
	Part No.	102795	Ref. No. —
	olive for pipe ø 4mm Qty 1 pcs		
	Part No.	102797	Ref. No. —
	olive for pipe ø 6mm Qty 1 pcs		
	Part No.	106703	Ref. No. —
	pilot burner nozzle POLIDORO natural gas code 27.2 bore ø 2x0.27mm Qty 1 pcs		

Table continues overleaf



accessories for		102982	
	Part No.	106704	Ref. No. —
	pilot burner nozzle POLIDORO LPG code 16.2 bore $\varnothing$ 2x0.16mm Qty 1 pcs		
	Part No.	106763	Ref. No. —
	pilot burner nozzle POLIDORO natural gas code 27.2A bore $\varnothing$ 2x0.27mm Qty 1 pcs		
	Part No.	106859	Ref. No. —
	pilot burner nozzle POLIDORO LPG code 24 bore $\varnothing$ 0.24mm Qty 1 pcs		

## electrodes

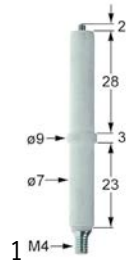
			
<b>Part No.</b>	102314	<b>Ref. No.</b>	90.028
<b>description</b>	ignition electrode D1 $\varnothing$ 7mm D2 $\varnothing$ 9mm connection M4 L1 2mm BL1 28mm BL2 3mm BL3 23mm to clip		

## piezoelectric igniters

mounting diameter 18mm

			
<b>Part No.</b>	100009	<b>Ref. No.</b>	90.015
<b>description</b>	piezoelectric igniter body plastic blowing mounting $\varnothing$ 18mm connection $\varnothing$ 2.4mm front measurements 26mm M18x1.5		
<b>accessories for</b> 100009			
	Part No.	101339	Ref. No. —
	cover cap for piezoelectric igniter		
	Part No.	106869	Ref. No. —
	cover cap for piezoelectric igniter ID $\varnothing$ 22mm ED $\varnothing$ 35mm H 25mm		
	Part No.	107931	Ref. No. —
	cover cap for piezoelectric igniter ID $\varnothing$ 21mm ED $\varnothing$ 36mm		

## thermocouples

plug-in thermocouples

plug-in thermocouples standard

with barrel socket  $\varnothing$  6(6.5)mm

thermocouples SIT

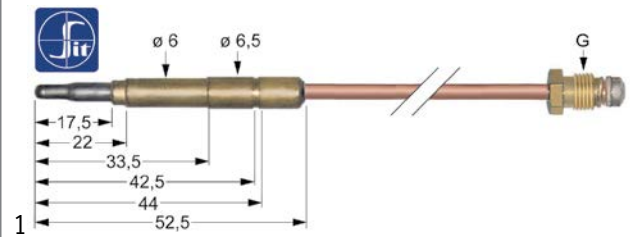

<b>Part No.</b>	107601	<b>Ref. No.</b>	90.068
<b>description</b>	thermocouple SIT M8x1 L 600mm plug connection $\varnothing$ 6.0(6.5)mm		

## gas burners

bar burners

bar burners



<b>Part No.</b>	104735	<b>Ref. No.</b>	1.501
<b>description</b>	bar burner 4 row L 490mm W 335mm $\varnothing$ mm H 30mm		

## gas nozzles

main nozzles

gas nozzles 1/8"



<b>Part No.</b>	102798	<b>Ref. No.</b>	90.039
<b>description</b>	gas injector thread 1/8" WS 11 bore $\varnothing$ 1.6mm		

**GASTRO**PARTS.COM

